

JMA®



SUPLEMENTO-SUPPLEMENT

LLAVES + ESPECIALISTA - KEYS + SPECIALIST

C11.2020

www.jma.es

A2 JMA es Compromiso

JMA Konpromisoa da
JMA is Commitment
JMA, l'engagement
JMA bedeutet Verpflichtung

A3-A5 Nuevos Productos

New Products
Produktu berriak
Nouveaux produits
Neue Produkte

A6-A7 Aviso Legal

Mezu Legala
Legal Warning
Informations Légales
Rechtliche Hinweise

A8-A9 Descripción y Terminología

Deskribapen eta Terminologia
Description and Terminology
Description et Terminologie
Begriffserklärung und Terminologie

A10-A11 Símbolos y Nacionalidades

Ikur eta Nazionalitateak
Symbols and Nationalities
Symboles et Nationalités
Symbole und Nationalitäten

A11-A14 ÍNDICES
AURKIBIDEA
INDEX
INDEX
GESAMTVERZEICHNIS**A12 Índice General**

Aurkibidea
General Index
Index Generale
Gesamtverzeichnis

A14 Índice de Marcas

Marken Aurkibidea
Brand Index
Index Marque
Hauptmarke

1-37 LLAVES
GILTZAK
KEYS
CLÉS
SCHLÜSSEL**1 - 37 Imágenes de Llaves**

Giltzen Irudiak
Keys Images
Images Clés
Schlüssel Bilder

B1 -B9 CAT. ESPECIALISTA DE MÁQUINAS DUPLICADORAS
KOPIATZEKO MAKINEN GIDA ESPEZIALISTA
KEY CUTTING SPECIALIST'S GUIDE
SPÉCIALISTE CATALOGUE DE MACHINES DUPLICATRICES
SPEZIALISTKATALOG

NUESTRO ÉXITO ESTÁ BASADO EN EL COMPROMISO DE LAS PERSONAS**OUR SUCCESS IS BASED ON OUR PEOPLE'S COMMITMENT**

Alejandro Altuna S.L.U es la sociedad matriz e impulsora de Altuna Group. Fabrica todo tipo de llaves para cerradura así como máquinas duplicadoras. Sus productos van destinados al mercado OEM y a la reposición, en este caso con la marca JMA.

Alejandro Altuna S.L.U. is the parent company and driving force behind the Altuna Group. It manufactures all types of lock-keys and key-cutting machines. Its products are for the OEM and replacement markets, in the latter case with the JMA brand.

Fundada por el Sr. Alejandro Altuna en 1942 arrancó su actividad en Mondragón. Posteriormente, la estrategia de apertura de mercados exteriores apoyada en la internacionalización y siempre basada en un enfoque innovador de los procesos industriales, ha convertido a ALTUNA GROUP en el primer productor de llaves europeo y referente mundial en este campo.

Set up by Alejandro Altuna in 1942, it started the production in Mondragón (Spain). Later, the strategy of opening up to foreign markets backed by globalisation and always based on an innovative attitude towards industrial processes, turned the ALTUNA GROUP into the largest producer of keys in Europe and a benchmark worldwide in the field.

Actualmente, 15 compañías en 4 continentes trabajan conjuntamente para el desarrollo y potenciación de la fuerza de nuestra marca JMA, conocida en más de 100 países en todo el mundo.

Currently 15 companies in four continents work together to develop the strength of our JMA brand, well known in more than 100 countries all over the world.

JMA integra equipos de personas comprometidas y motivadas por un proyecto común que nos ha permitido ser el mayor fabricante de llaves de Europa.

This successful trail that led us to be the biggest key producer in Europe is based in our people's commitment to be:

LIDER EN TECNOLOGÍA:

Una apuesta sólida por la calidad y la innovación basada en la automatización y garantía de procesos y soportada por una vocación inversora a largo plazo.

**THE LEADER IN TECHNOLOGY,**

looking for the latest developments to improve the production processes together with a strong investment policy in all our plants to ensure the company's competitiveness and long-term future.

LIDER EN CALIDAD:

Nuestra política de calidad se basa en la prevención y planificación, mejora continua, satisfacción del cliente y participación de las personas. Además de la Certificación en Calidad de acuerdo a la ISO 9001, Alejandro Altuna S.L.U. acoge Sistemas de Gestión de la Calidad homologados por las empresas líderes del sector de automoción y residencial.

**THE LEADER IN QUALITY:**

Our quality policy is based on prevention and planning, continuous improvement, customer satisfaction and people participation. In addition to Quality Certification to ISO 9001, Alejandro Altuna S.L.U. operates Quality Management Systems approved by the leading companies in the automotive and residential sectors.

LIDER EN EL COMPROMISO POR EL MEDIO AMBIENTE:

En Alejandro Altuna S.L.U. las buenas prácticas medioambientales son la norma y no la excepción. Nuestro equipo forma parte de un proyecto de empresa respetuoso con el medioambiente y que colabora con el desarrollo sostenible de nuestro entorno. Alejandro Altuna S.L.U. fue el primer fabricante mundial de llaves en conseguir en 2000 el certificado ISO 14001 para su Sistema de Gestión.

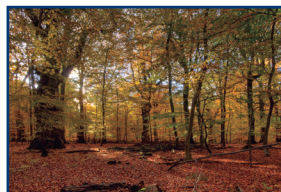
**THE LEADER IN THE COMMITMENT TO THE ENVIRONMENT:**

At Alejandro Altuna S.L.U. best environmental practice is the norm and not the exception. Our team is part of a business project that respects the environment and contributes to the sustainable development of our community. Alejandro Altuna S.L.U. was the first key manufacturer in the world to achieve ISO 14001 certification for its management system in 2000.

LIDER EN SERVICIO:

La realidad de una empresa se demuestra en su capacidad por responder con la máxima celeridad y eficacia a las necesidades y exigencias de los clientes. Se encuentren donde se encuentren. Además, gracias a su amplia red de filiales y empresas distribuidoras repartidas por todo el mundo, le permite llegar a cualquier cliente, se cual sea su ubicación.

**THE LEADER IN SERVICE,**

The efficiency of a company is shown in its capacity to respond with the maximum speed and effectiveness to the needs and requirements of its customers, wherever they are based. Moreover, with its extensive network of associate and distribution companies located throughout the world, the company can reach any customer, wherever based.

NUEVOS PRODUCTOS

NEW PRODUCTS

JMACLOUDPRO

THE FUTURE OF KEY DUPLICATION

MARKET INNOVATION



EL PRIMER SOFTWARE EN LA NUBE PARA EL DUPLICADO DE LLAVES

JMACLOUDPRO abre una nueva etapa en la aplicación para el duplicado de llaves, al ser la primera aplicación en la nube del mercado. Un gran avance que permite a los usuarios del programa JMAKeyPro guardar un histórico de los duplicados de llaves de sus clientes.

THE FIRST CLOUD-BASED KEY DUPLICATION SOFTWARE

JMACLOUDPRO is setting a new trend in key duplication software by being the first cloud-based app in the market. This major step forward allows users of the JMAKeyPro programme to save a record of the keys they duplicate for their customers.

TPX8+

**LA TECNOLOGÍA DEFINITIVA
PARA LA COPIA DEL MEGAMOS[®] CRYPTO
THE DEFINITIVE TECHNOLOGY
FOR COPYING MEGAMOS[®] CRYPTO**



CLICK & FIND



NOMAD

**UNA COMPAÑERA DE VIAJE
LIGERA Y COMPACTA
A LIGHTWEIGHT AND COMPACT
TRAVEL MATE**



NUEVOS PRODUCTOS

NEW PRODUCTS



BT MULTIUSER

ABRA LAS PUERTAS A LA TECNOLOGÍA MÓVIL PARA MÚLTIPLES USUARIOS

OPEN THE DOORS TO MOBILE TECHNOLOGY FOR MULTIPLE USERS



M-NOVA



LITE



M-Q MAX



SINGLE & DUPLA

TODAS LAS PRESTACIONES DE MULTICODE CON LA MÁXIMA FLEXIBILIDAD

ALL THE MULTICODE FEATURES WITH THE MAXIMUM FLEXIBILITY

ESPAÑOL

AVISO LEGAL - SUPLEMENTO C11.2020

Las llaves que aparecen en este catálogo son piezas JMA fabricadas por JMA Alejandro Altuna S.L.U. o un subcontratista de éste. Están diseñadas para cilindros y cerraduras de los fabricantes cuyas marcas se indican en este catálogo.

Conforme a las disposiciones legales vigentes relativas a la propiedad industrial, las marcas o nombres comerciales indicados en este catálogo son propiedad exclusiva de los fabricantes de cilindros y cerraduras, así como de los fabricantes de automóviles, otros constructores, distribuidores y usuarios.

Dichas marcas o nombres comerciales se indican en calidad simplemente informativa con el fin de reco-

nocer con rapidez la cerradura a la que corresponden nuestras piezas.

Este catálogo está reservado exclusivamente a profesionales de la reproducción de llaves que utilizan piezas JMA.

Los datos referentes a los productos de este catálogo tienen carácter indicativo. Manteniendo siempre las características básicas, nos reservamos el derecho de realizar, sin previo aviso, modificaciones técnicas, estéticas o de otro tipo, por razones de evolución de los productos en cuestión.

Algunos modelos que están en este nuevo catálogo podrán recibirlos tanto con la marca y la referencia JMA como con otra marca del grupo ALTUNA.

EUSKERA

LEGE-OHARRA - C11.2020 SUPLEMENTO A

Katalogo honetan ageri diren giltzak Alejandro ALTUNA SLU enpresak edo honek kontratatutako beste enpresabatekin dako JMA piezak dira. Katalogoan zehaten diren marken fabrikatzaileen zilindro eta sarrailetarako diseinatuta daude.

Jabetza industrialari buruz indarrean dauden lege-xedapeneekin bat etorritik, katalogo honetan zehaztutako merkataritza-markak edo izenak zilindro eta sarraileen fabrikatzaileen nahiz ibilgailuen fabrikatzaileen eta beste erakitzailen, banatzaile eta erabiltzaile batzuen jabetza eskusibokoak dira.

Merkataritza-marka edo izen horiek zehaztasun gehiago emateko adierazten dira, gure piezak zein sarraileri dagozkion berehala ikusi ahal izateko.

Katalogo hau giltzen kopia egiteko JMA piezak erabiltzen dituzten profesionalentzako da soilik.

Katalogo honetako produktuei buruzko datuek izaera adierazgarria dute. Oinarritzko ezaugarriak gordez, produktuen bilakaeraren ondoriozko aldaketa teknikoak, estetikoak edo bestelakoak egiteko eskubidea dugu, aurretik horren berri eman beharrik gabe.

Katalogo berri honetan dauden eredueta batak JMA marka eta erreferentziarekin nahiz ALTUNA taldeko beste marka batekin jaso ahal izango dira.

ENGLISH

LEGAL WARNING - SUPPLEMENT C11.2020

The keys that appear in this catalogue are JMA parts manufactured by JMA Alejandro Altuna S.L.U. or one of its subcontractors. They are designed for cylinders and locks made by the manufacturers whose trademarks are indicated in this catalogue.

In accordance with legal requirements relating to industrial property rights, the trademarks or trade names indicated in this catalogue are the exclusive property of the manufacturers of the cylinders and locks, as well as automobile manufacturers, other constructors, distributors and users.

The aforementioned trademarks or trade names are indicated simply for information purposes so that the lock to which our parts correspond can be recognised quickly and easily. This catalogue is for the exclusive use of professional key copiers who use JMA parts.

Data referring to the products in this catalogue are indicative in nature. Although the basic characteristics are maintained at all times, we reserve the right to make, without previous notice, any technical, aesthetic or other types of changes involved in the development of the products in question. Some of the keys in this new catalogue could be received either with the JMA reference and trademark or with another trademark from the ALTUNA group.

FRANÇAIS

MENTIONS LEGALES - SUPPLEMENT C11.2020

Les ébauches de clés reportées sur ce catalogue sont des ébauches JMA fabriquées par JMA Alejandro Altuna S.L.U. ou un de ses sous-traitants. Elles sont destinées aux cylindres et serrures des fabricants dont les marques sont indiquées dans ce catalogue.

Conformément aux dispositions légales en vigueur relatives à la propriété industrielle, les marques ou les dénominations commerciales citées dans ce catalogue sont la propriété exclusive des fabricants de cylindres et de serrures ainsi que des constructeurs de voitures, autres constructeurs, distributeurs et utilisateurs.

Ces marques ou dénominations commerciales sont indiquées à titre de simple information afin de connaître rapidement à quelle serrure nos ébauches sont destinées.

Ce catalogue est exclusivement réservé aux professionnels de la reproduction de clés, utilisant des ébauches JMA.

Les renseignements sur les produits de ce catalogue sont donnés à titre indicatif. Tout en gardant les caractéristiques de base, nous nous réservons le droit d'apporter, sans préavis, des modifications techniques, esthétiques ou autres, dues à l'évolution des produits en question.

Des ébauches de ce catalogue pourront être livrées soit avec la marque et référence JMA soit avec une autre marque du groupe ALTUNA.

DEUTSCH

RECHTSHINWEIS- NACHTRAG C11.2020

Die in dem vorliegenden Katalog aufgeführten Schlüssel sind JMA-Teile, die von der Firma Alejandro ALTUNA, S.L.U., einem Zulieferanten von JMA, hergestellt werden. Sie sind für Zylinder und Schlösser derjenigen Hersteller entwickelt worden, deren Marken in diesem Katalog aufgeführt sind.

In Übereinstimmung mit den geltenden gesetzlichen Vorschriften bezüglich des gewerblichen Eigentums sind die im vorliegenden Katalog aufgeführten Marken und Firmennamen ausschließliches Eigentum der Zylinder- und Schloßhersteller, sowie der Automobilhersteller und anderer Konstrukteure, Vertrieber und Benutzer.

Diese Marken und Firmennamen werden nur zu Informationszwecken aufgeführt, mit dem Ziel, auf schnelle Weise zu erkennen, zu welchem Schloß unsere Teile gehören.

Dieser Katalog ist ausschließlich für Fachleute des Bereichs der Schlüsselreproduktion gedacht, die JMA-Teile verwenden.

Die Daten bezüglich der Produkte des vorliegenden Katalogs haben informativen Charakter. Bei Aufrechterhaltung der grundlegenden Eigenschaften behalten wir uns das Recht vor, aus Gründen der Entwicklung der entsprechenden Produkte und ohne Vorankündigung technische, ästhetische oder andere Änderungen vorzunehmen. Einige Modelle des neuen Katalogs können Sie sowohl mit der Marke und der Bezeichnung JMA erhalten, als auch mit jeder anderen Marke der Gruppe ALTUNA.

THE KEY TO EXCELLENCE
GLOBALLY UNLOCKING MILLIONS OF DOORS DAILY



MANUAL DE USO

MANUAL OF USE

ESPAÑOL

MANUAL DE USO

Todas las llaves del catálogo están en escala 1:1; tanto la silueta como el perfil, para hacer una búsqueda más fácil y precisa. Pasos a seguir para la identificación de la llave:

1. Identificación de la silueta: Confirmar que la llave que busca coincide con las dimensiones de la llave catálogo. Ver Fig. 1

2. Identificación del perfil:

2.1 Ver si el perfil de la llave y el perfil del catálogo forman una misma imagen. Ver Fig. 2.1

2.2 Cerciorar que el perfil del catálogo tiene la misma forma y dimensión, colocando la llave física sobre la imagen del catálogo. Ver Fig. 2.2

EUSKERA

ERABILERA-ESKULIBURUA:

Katalogoko giltza guztiak 1:1 eskalan agertzen dira; hala silueta nola profila, bilaketa errazagoa eta zehatzagoa izan dadin. Giltza identifikatzeko urratsak:

1. Silueta identifikatzea: Bilatzen den giltzak katalogoan agertzen den giltzaren dimentsio bera duela baieztatu. Ikus 1. irudia.

2. Profila identifikatzea:

2.1 Giltzaren profilak eta katalogoko profilak irudi bera osatzen duten ikusi. Ikus 2.1. irudia.

2.2 Katalogoko profilak forma eta dimentsio bera duela ziurtatzea, giltza fisikoa katalogoko irudiaren gainean jarri. Ikus 2.2. irudia.

ENGLISH

MANUAL OF USE

All the keys in this catalogue are 1:1 scale; both the silhouette outline and profile, to facilitate a precise search. Steps to follow for identifying the key:

1. Identification of the silhouette: Confirm that the key you want matches with the dimensions of the key in the catalogue. See Fig. 1

2. Identification of the profile:

2.1 Check to see if the profile of the original key and the profile in the catalogue have a similar shape. See Fig. 2

2.2 Make sure the profile of the catalogue has the same shape and dimension, by placing the physical key over the image in the catalogue. See Fig. 2.2

FRANÇAIS

MANUEL D'UTILISATION

Toutes les clés du catalogue sont à l'échelle 1:1; aussi bien la silhouette que le profil, afin de permettre une recherche plus simple et précise. Étapes à suivre pour l'identification de la clé :

1. Identification de la silhouette : Confirmer que la clé recherchée correspond aux dimensions de la clé du catalogue. Voir Fig.1

2. Identification du profil :

2.1. Voir si le profil de la clé correspond au profil du catalogue. Voir Fig.2.1

2.2. S'assurer que le profil du catalogue a la même forme et les mêmes dimensions, en plaçant la clé physique sur l'image du catalogue. Voir Fig.2.2

DEUTSCH

HANDBUCH

Alle Schlüssel im Katalog sind im Maßstab 1:1 dargestellt, sowohl als Silhouette als auch im Profil, um die Suche leichter und genauer zu machen. Zu befolgende Schritte für die Identifizierung des Schlüssels:

1. Identifizierung der Silhouette: Bestätigung, dass der gesuchte Schlüssel mit dem Abmessungen im Katalog übereinstimmt. Siehe Abb. 1

2. Identifizierung des Profils:

2.1. Prüfen, ob das Profil des Schlüssels und das im Katalog gezeigte Profil übereinstimmen. Siehe Abb. 2.1

2.2. Vergewissern, dass das Profil im Katalog die gleiche Form und Größe hat, indem man den tatsächlichen Schlüssel auf das Katalogbild legt. Siehe Abb. 2.2

IDENTIFICACIÓN DE LA LLAVE

KEY IDENTIFICATION

1. Identificación de la Silueta

Silhouette identification

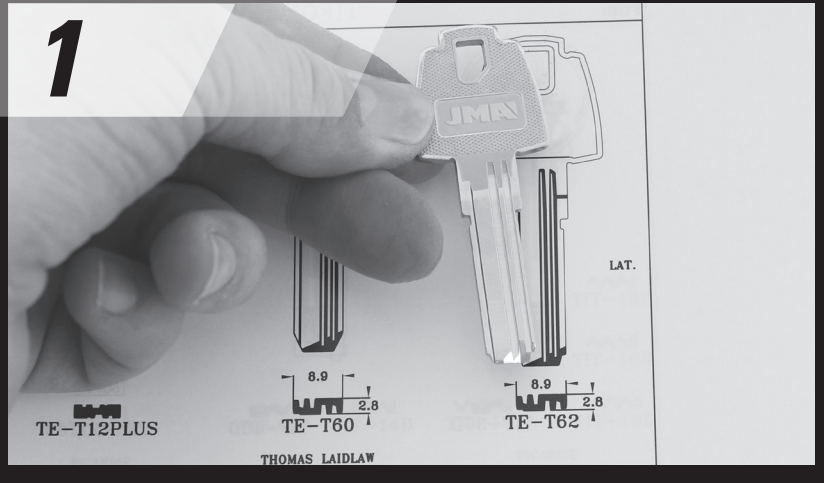

2. Identificación del perfil

Identification of the profile

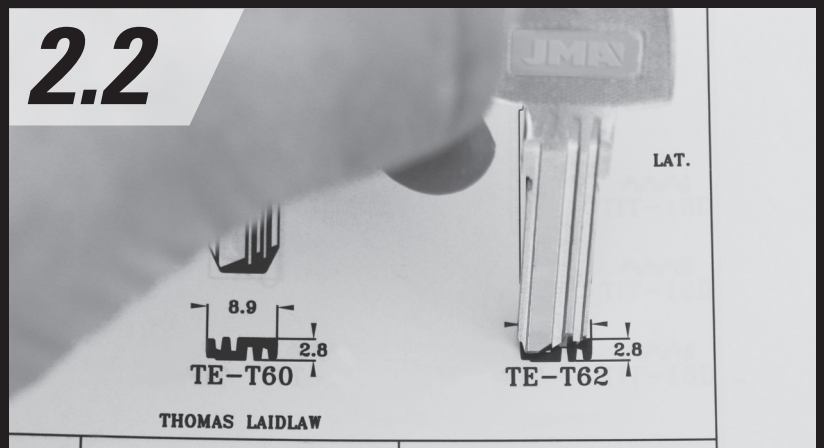

ESPAÑOL

- 1 — MARCA PRINCIPAL
- 2 — CABEZA
- 3 — CUELLO
- 4 — TOPE
- 5 — PALETÓN
- 6 — PUNTA
- 7 — UTILIZACIÓN
- 8 — NOMENCLATURA DE PERFIL ORIGINAL
- 9 — PERFIL IZQUIERDO
- 10 — PERFIL DERECHO
- 11 — REFERENCIA
- 12 — MARCAS SECUNDARIAS
- 13 — SERIES
- 14 — MARCA PRINCIPAL DE LA PRINCIPAL (ABSA)
- 15 — MARCAS SECUNDARIAS DE LA PRINCIPAL (ABSA)

1 — ABSA

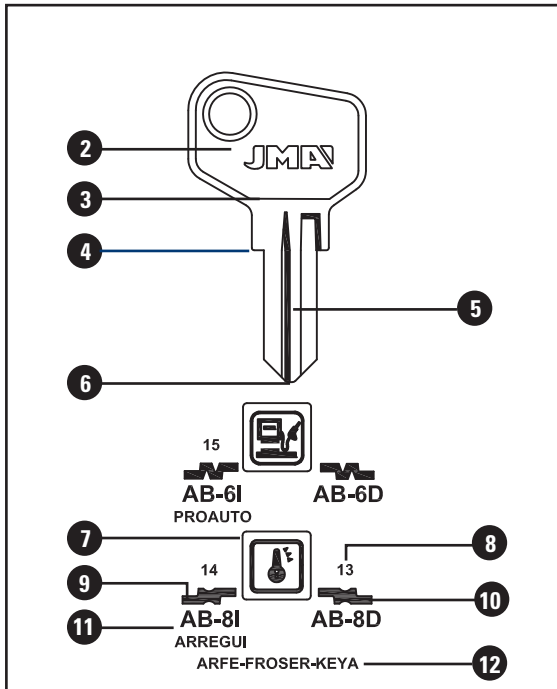

1 — VACHETTE

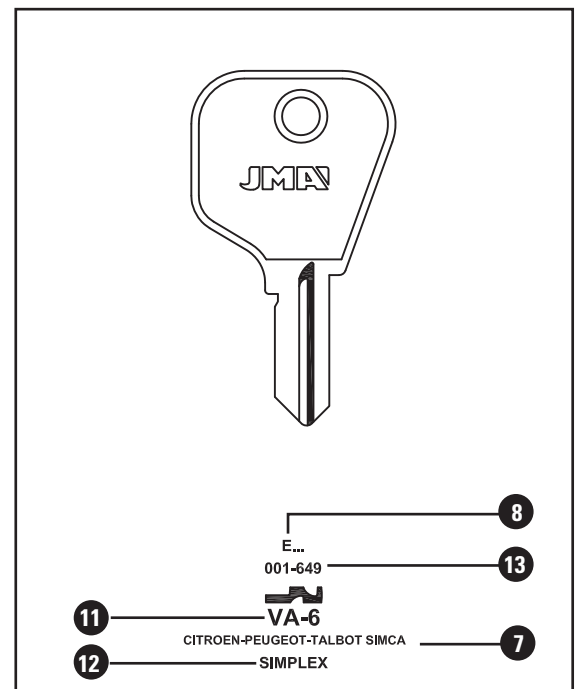

EUSKERA	ENGLISH	FRANÇAIS	DEUTSCH
1 MARKA NAGUSIA	1 MAIN BRAND	1 MARQUE PRINCIPALE	1 HAUPTPRÄGUNG
2 BURUA	2 HEAD	2 TÊTE	2 KOPF
3 LEPOA	3 NECK	3 COU	3 HALS
4 TOPEA	4 SHOULDER	4 ARRÊT	4 ANSCHLAG
5 BELARRIA	5 BLADE	5 CANON	5 SCHAFT
6 PUNTA	6 TIP	6 POINTE	6 SPITZE
7 ERABILERA	7 USE	7 UTILISATION	7 VERWENDUNG
8 JATORRIZKO PROFILAREN IZENDEGIA	8 ORIGINAL PROFILE	8 PROFIL ORIGINAL	8 ORIGINALPROFIL
9 EZKERREKO PROFILA	9 LEFT PROFILE	9 PROFIL GAUCHE	9 LINKSPROFIL
10 ESKUINEKO PROFILA	10 RIGHT PROFILE	10 PROFIL DROIT	10 RECHTSPROFIL
11 ERREFERENTZIA	11 REFERENCE	11 RÉFÉRENCE	11 BEZEICHNUNG
12 BIGARREN MAILAKO MARKAK	12 SECONDARY BRAND	12 MARQUE SECONDAIRE	12 2. PRÄGUNG
13 SERIEAK	13 SERIES	13 CODE	13 SERIE
14 MARCA NAGUSIA ETA JATORRIZKOA	14 MAIN BRAND AND NATIONALITY	14 MARQUE PRINCIPALE ET NATIONALITÉ	14 HAUPTPRÄGUNG UND NATIONALITÄT
15 MARCA NAGUSIAREN BIGARREN MAILAKO MARKAK (ABSA)	15 SECONDARY BRANDS OF THE MAIN ONE (ABSA)	15 MARQUES SECONDAIRES DE LA PRINCIPALE (ABSA)	15 2. PRÄGUNG FÜR HAUPTPRÄGUNG (ABSA)

DESCRIPCIÓN Y TERMINOLOGÍA

KEY DESCRIPTION AND TERMINOLOGY

ESPAÑOL

- 1 CABEZA
- 2 CUELLO
- 3 DIÁMETRO DE LA CAÑA
- 4 CAÑA
- 5 LONGITUD A
- 6 PALETON
- 7 PERFIL MACHO
- 8 REFERENCIA
- 9 MARCA ORIGINAL
- 10 PERFIL HEMBRA

PARA-F

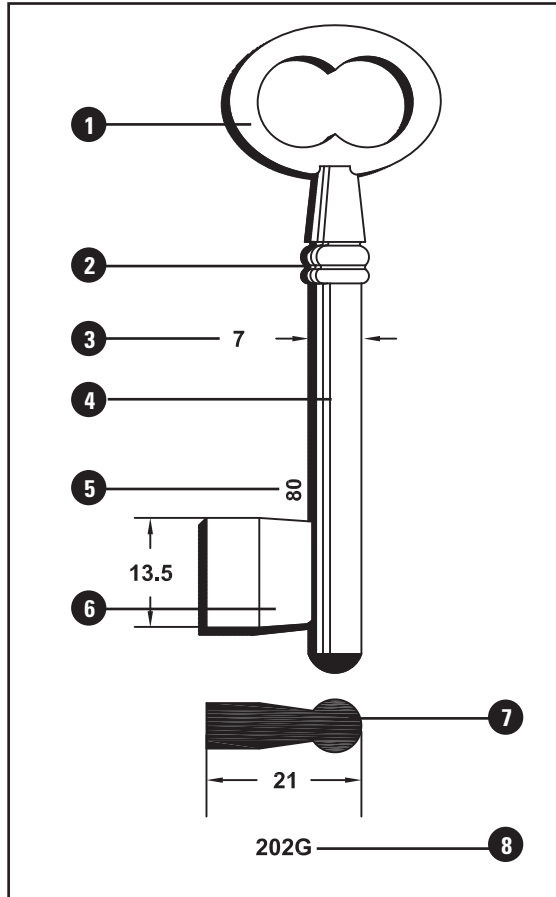

9 ORENGO

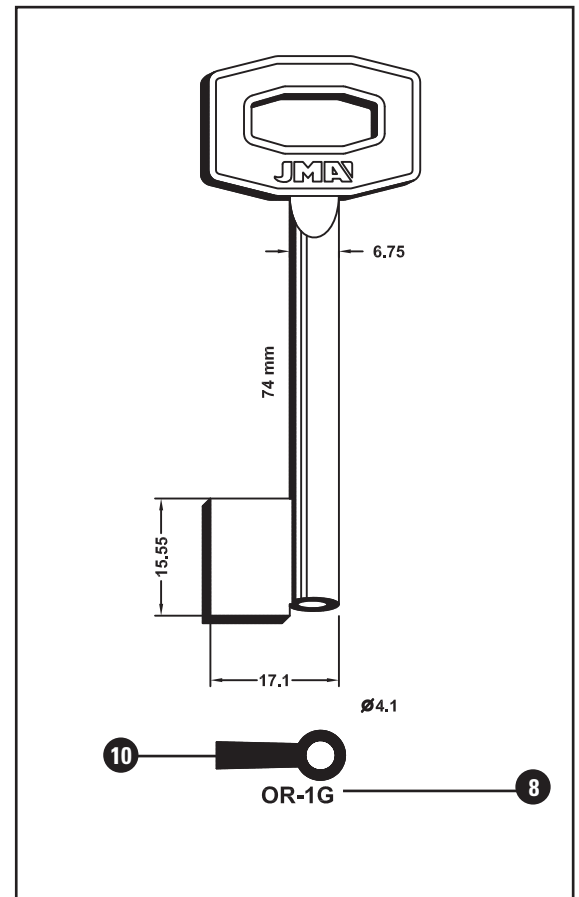

EUSKERA

- 1 BURUA
- 2 LEPOA
- 3 ZIRIAREN
DIAMETROA
- 4 ZIRIA
- 5 A LUZERA
- 6 BELARRIA
- 7 PROFIL ARRA
- 8 ERREFERENTZIA
- 9 JATORRIZKO
MARKA
- 10 PROFIL EMEA

ENGLISH

- 1 HEAD
- 2 NECK
- 3 SHANK
DIAMETER
- 4 SHANK
- 5 LENGTH A
- 6 BIT
- 7 PIN BIT PROFILE
- 8 REFERENCE
- 9 ORIGINAL BRAND
- 10 PIPE BIT PROFILE

FRANÇAIS

- 1 TÊTE
- 2 COU
- 3 DIAMETRE DU
CANON
- 4 CANON
- 5 LONGUEUR A
- 6 PANNETON
- 7 PROFIL MALE
- 8 RÉFÉRENCE
- 9 MARQUE
ORIGINALE
- 10 PROFIL FEMELLE

DEUTSCH

- 1 KOPF
- 2 HALS
- 3 HALM-
DURCHMESSER
- 4 HALM
- 5 LÄNGE A
- 6 BART
- 7 SCHWEIFUNG
- 8 BEZEICHNUNG
- 9 ORIGINAL-
PRÄGUNG
- 10 GEBOHRT

ALP.

Llave fabricada en alpaca

Alpakaz egindako giltza
Key available in nickel silver
Clé fabriquée en maillechort
Schlüssel auch in Neusilber lieferbar



35

Llave de utilización en candados

Giltzarrapoetan erabiltzeko giltzak
Key for padlocks
Clé pour cadenas
Schlüssel für Hangschlösser

LAT.

Llave disponible también en latón

Giltza, letoizkoa ere eskuragarria
Key also available in brass
Clé aussi disponible en laiton
Schlüssel auch in Messing lieferbar



Llave de utilización en cerraduras auxiliar

Sarraila osagarrietan erabiltzeko giltzak
Key for cam locks
Clé pour petite serrurie
Schlüssel für Hebelschlösser

COL.

Llave disponible también con cabeza de plástico en colores

Giltza hau koloretako plastikozko buruarekin ere eskuragarria

Key also available with coloured plastic head

Clé aussi disponible avec tête plastifiée en couleurs

Schlüssel auch mit farbigem Plastikkopf lieferbar



Llaves para motocicletas

Motozikleta giltzak
Key for motorcycles
Clé pour motocyclettes
Schlüssel für Motorräder

ALU.

Llave disponible también en aluminio

Giltza, aluminioan ere eskuragarria
Key also available in aluminium
Clé aussi disponible en aluminium
Schlüssel auch in Aluminium lieferbar



Llave para tapón de gasolina

Gasolina-tapoiatarako giltza
Key for fuel cap
Clé pour bouchon d'essence
Schlüssel für Tankdeckel

ZAM.

Llave fabricada solamente en zamak

Zamakez soilik egindako giltza
Key only available in zamak
Clé aussi disponible en zamak
Schlüssel nur aus Zamak lieferbar



Llave para camión

Kamioiko giltza
Key for lorries
Clé pour camion
Schlüssel für Lastkraftwagen



Alarma

Alarma
Alarm
Alarme
Alarm



Llaves gorja con acabado en color natural

Gorja giltzak berezko kolorezko akaberarekin
Bit key blank with natural colour finishing
Clé à gorges avec finition en couleur naturel
Chubbsschlüssel in naturfarben Ausführung



Llaves gorja con acabado en negro antiguo

Gorja giltza, beltz zaharkitu akaberarekin
Bit key blank with old black finishing
Clé à gorges avec finition en vieux noir
Chubbsschlüssel in altschwarzer Ausführung

NACIONALIDAD - NAZIONALITATEA - NATIONALITY - NACIONALITÉ - NATIONALITÄT

AUSTRIA
AUSTRALIA
BELGIUM
BRAZIL
CANADA
SWITZERLAND
GERMANY
DENMARK

A
AUS
B
BR
CDN
CH
D
DK

ALGERIA
SPAIN
ESLOVAKIA
EGYPT
FRANCE
GREAT BRITAIN
GREECE
HUNGARY

DZ
E
ES
ET
F
GB
GR
H

HONG KONG
CROATIA
ITALY
ISRAEL
INDIA
EIRE
JAPAN
KOREA

HK
HR
I
IL
IND
IRL
J
K

SÍMBOLOS

SYMBOLS

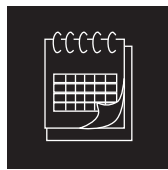

Calendario

Egutegia
Calendar
Calendrier
Kalender

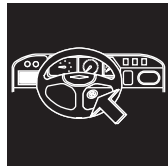

Contacto auto

Autoko kontaktua
Engine ignition
Contact auto
Zündschloss Pkw

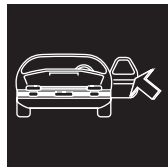

Puerta

Atea
Door lock
Portière
Türe

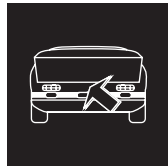

Maletero/Puerta trasera

Maletategia/Atzeko atea
Boot/Hatchback
Coffre/Portière postérieure
Kofferraum/Hecktür



Tapón de gasolina

Gasolina-tapoia
Petrol cap
Bouchon réservoir
Benzintankverschluss

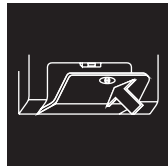

Guantera

Eskularru-kutxa
Drawer
Tiroir
Schublade

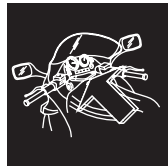

Contacto moto

Moto-kontaktua
Motorbike ignition
Contact moto
Zündschloss Motorrad

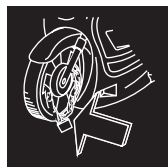

Bloqueo moto

Moto-blokeoa
Motorbike disc lock
Bloquage moto
Bremsenschloss Motorrad



Sillin

Zela
Cycle seat
Selle
Sattel



Casco

Kaskoa
Helmet
Casque
Helm



Automovil / camioneta

Automobila / kamioneta
Car / Pick-up trucks
Voiture / Camionnette
Auto / Kleintransporter

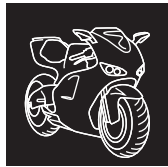

Motocicleta

Motozikleta
Motorcycle
Motocyclette
Motorrad



Camión

Kamioia
Trucks
Camion
Lkw



Avión

Hegazkina
Aeroplane
Avion
Flugzeuge

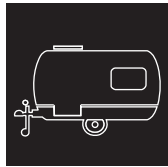

Caravana

Karabana
Caravans
Caravane
Wohnwagen



Motor marino

Itsas motorra
Boat engines
Moteur de bateau
Schiffsmotoren

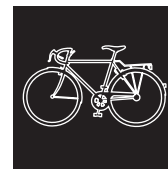

Bicicleta

Bizikleta
Bicycle
Bicyclette
Fahrräder

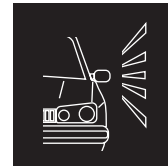

Alarma

Alarma
Alarm
Alarme
Alarm

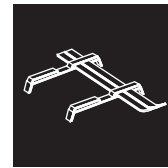

Portaesquis

Eski-euskarria
Ski holder
Porte ski
Skiträger

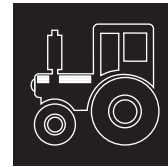

Tractor

Traktorea
Tractor
Traktor
Landmaschinen

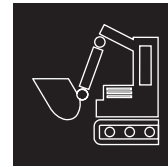

Escavadora

Hondeatzailea
Earth moving machine
Machine déplacement de terre
Baumaschinen



Carretilla elevadora

Orga jasotzailea
Forklift
Clark
Gabelstapler



Corta cesped

Belarra mozteko makina
Lawn-mower
Tondeuse
Rasenmäher



Alarma - llave

Alarma - giltza
Alarm - key
Alarme - clef
Alarm - Schlüssel

KUWAIT
MEXICO
NORWAY
THE NETHERLANDS
PORTUGAL
PERU
POLAND
ARGENTINA

KW
MEX
N
NL
P
PE
PL
RA

TAIWAN
CHILE
CHEKIA
RUMANIA
SWEDEN
FINLAND
SLOVENIA
RUSIA

RC
RCH
RCZ
RU
S
SF
SLO
RUS

CHINA
TUNISIA
UNITED STATES OF AMERICA
YUGOSLAVIA
VENEZUELA
ZAMBIA

TJ
TN
USA
YU
YV
Z

ÍNDICE
AURKIBIDEA
INDEX
INDEX
GESAMTVERZEICHNIS



SUPLEMENTO-SUPPLEMENT
C.11 2020

THE KEY TO EXCELLENCE
GLOBALLY UNLOCKING MILLIONS OF DOORS DAILY

ÍNDICE GENERAL

INDIZE OROKORRA • GENERAL INDEX • INDEX GENERALE • GESAMTVERZEICHNIS

REF.	PAG.	REF.	PAG.	REF.	PAG.	REF.	PAG.	REF.	PAG.
101-1G	32	BK-16/11	3	CI-71P	5	DOM-77D	6	FO-24C9	25
101-2G	32	BK-21/3	3	CI-72P	5	DOM-78D	6	FO-43D	24
716-1G	32	BK-21/4	3	CI-73P	5	DOM-79D	6	FTH-30	8
716-2G	32	BK-21/5	3	CI-75P	5	DOM-80	6	FV-3	8
ABL-3D	1	BK-21/6	3	CI-76P	5	DOM-80D	6	GARD-2G	34
ABU-100	1	BK-21/8	3	CI-77P	5	DOM-B2	7	GD-1DP	8, 24
ABU-35DP	1, 24	BK-21/10	3	CI-78P	5	DOM-B6	7	GD-1P	8, 24
ABU-70D	1	BK-21/16	3	CI-79P	5	DR-2D	6	GDA-4D	9
ABU-87P	1, 24	BK-22	3	CI-80P	5	ELB-2G	33	GDA-5	9
ABU-88P	1, 24	BK-23	3	CI-81	5	ELB-3G	33	GE-22/1	9
ABU-89D	1	BK-26/125	3	CI-81P	5	ELZ-13	7	GE-22/2	9
ABU-90	1	BK-26/135	3	CI-82P	5	ESP-4D	7	GE-22/3	9
ABU-91	1	BK-26/145	3	CI-83P	5	EU-15P	24	GE-22/4	9
ABU-92	1	BK-26/235	3	CI-84P	5	EU-16DP	24	GE-22/5	9
ABU-92D	1	BK-26/237	3	CI-DL WINDCOLOR	5	EU-17	7	GE-22/6	9
ABU-93	2	BK-26/245	3	CI-GDL	5	EUB-2D	7	GE-22/7	9
ABU-94D	1	BK-26/246	3	CIT-1C1	28	EUP-4D	7	GE-22/8	9
ABU-96	2	BMB-3	3	CLA-1G	32	EUS-1G	33	GE-22/11	9
ABU-99D/1	1	BMB-4	3	CLA-2G	33	EV-14	7	GE-22/12	9
ABU-99D/2	1	BMB-5	3	CLA-4G	33	EV-15D	7	GE-22/13	9
ABU-99D/3	1	BRI-1	32	CNP-2D	4	EV-28D/0	7	GE-22/15	9
AGA-55D	2	BRI-19 WINDCOLOR	3	COR-1D WINDCOLOR	5	EV-29D/0	7	GE-22/16	9
AMG-11	2	BRI-2	32	COR-230	5	EV-30	7	GE-22/17	9
AS-30D	2	BRI-3	32	COR-231	6	EVE-2	7	GE-22/18	9
ATL-1	2	BRN-1D	3	COR-232D	6	EZ-11G	34	GE-22/19	9
AX-5DP1	2, 24	BRN-2D	3	COR-61	5	EZ-DS15R WIND-COLOR	7	GEA-9/1	9
AX-6	2	BUR-35D	4	COR-70	5	FA-10G	34	GEA-9/3	9
AZ-37D WINDCOLOR	2	BUR-36	4	CRF-1D	4	FA-11G	34	GEA-9/4	9
BAB-13/1	2	BUR-36D	4	CVL-5D WINDCOLOR	6	FA-9G	34	GEA-9/6	9
BAB-13/2	2	BUR-37D	4	DAC-4DP	24	FAC-25	8	GEA-9/7	9
BAB-13/3	2	BUR-38	3	DAC-6DC1	24	FAIN-11 WINDCOLOR	8	GEA-9/9	9
BAB-13/4	2	BUR-39	4	DAC-6DP	24	FAV-3	8	GEA-9/10	9
BAB-13/5	2	BUR-39D	4	DAC-7DC1	24	FAV-3D	8	GEA-9/11	9
BAB-13/6	2	BUR-40D	4	DAT-15P4	27	FER-2D	8	GEA-9/13	9
BAB-13/7	2	BUR-41	4	DBX-1D	6	FER-3D	8	GEA-9/14	9
BAB-13/8	2	BUR-42D	4	DEB-1	33	FER-4D	8	GEA-9D/2	9
BAB-13/9	2	BUR-43	4	DEB-3	33	FF-10GD	8	GEA-9D/5	9
BAB-13/10	2	CAY-1D WINDCOLOR	4	DEK-16	6	FI-16C3	28	GEA-9D/7	9
BAB-13/11	2	CE-136D/1	5	DEK-17	6	FIC-400	34	GEA-9D/8	9
BAB-13/12	2	CE-136D/2	5	DEN-1	33	FLT-1	8	GEA-9D/12	9
BAB-20D/2	2	CE-136D/4	5	DLT-1D	6	FLT-1D	8	GER-2G	34
BAO-1	2	CE-136D/5	5	DOM-75	6	FO-24C3	25	GER-3G	35
BAO-1D	2	CI-48P	5	DOM-76D	6	FO-24C8	25	GER-4G	35
BK-16	3							GER-5G	35

ÍNDICE GENERAL

INDIZE OROKORRA • GENERAL INDEX • INDEX GENERALE • GESAMTVERZEICHNIS

REF.	PAG.	REF.	PAG.	REF.	PAG.	REF.	PAG.	REF.	PAG.
GEV-3D	9	KE-7	11	MUE-1	14	TCH-1DP	16	TX-13D	19
GOD-3	9	KI-11P	26	MUE-2	14	TCH-1P	16	U-15D WINDCOLOR	20
GOD-4	9	KI-12DP	26	NE-60C3	27	TE-8I WINDCOLOR	16	U-4GD	19
GUA-4	9	KI-12P	26	NEF-3	14	TE-T60 WINDCOLOR	16	U-5D WINDCOLOR	19
GUA-4D	9	KM-1P	26	NEF-4	14	TE-T80EH	17	U-5GD	19
GUA-5	9	KUB-1D	26	OJ-20/4	14	TIT-21	17	U-5I WINDCOLOR	19
GUA-5D	9	KUB-2D	26	OJ-21D	14	TIT-22	17	U-6D WINDCOLOR	19
GUS-1	10	KWI-1K	11	OMC-7	14	TIT-23	17	UCEM-8D WINDCOLOR	19
HAF-6	10	LAP-3	36	OP-11C3	25	TIT-24	17	UCEM-19	19
HEK-4D	10	LAP-100	36	PFA-23D	14	TIT-25	17	UCEM-20D	19
HEK-5	10	LB-2MD	12	PFA-24	15	TOK-82	17	UCEM-21	19
HEK-6	10	LB-5D	12	PFA-24D	15	TOK-83	17	VA-1T	37
HF-1D	10	LB-6D	12	PFA-25	15	TOK-83D	17	VA-2T	37
HGO-1	10	LF-47	12	PFA-25D	15	TOK-84D	17	VA-3T	37
HKO-1D	10	LF-50D	12	PFA-26D	15	TOK-85D	17	VA-5T	37
HOB-1G/36	35	LF-51	12	PL-1	20	TOK-86D	17	VA-8D WINDCOLOR	20
HOK-1D	10	LIN-21D WINDCOLOR	11	PL-1D	20	TOK-87D	17	VA-61C3	28
HOK-2D	10	LIN-25D WINDCOLOR	11	PR-21	15	TOK-88D	17	VA-75D WINDCOLOR	20
HU-4C1	25	LIN-26D	11	PR-22	15	TOU-1D	18	VA-91	20
HU-7C1	25	MAF-1	36	PTN-3D	15	TOV-8D	18	VA-400	37
HUD-3D	10	MAU-1	12	PTN-12G	37	TOYO-9P2	27	VA-700	37
HU-HCAP	25	MAU-2	12	RE-5	15	TOYO-15DP	27	VO-HVP1	25
HY-10	25	MAU-3D	12	RE-6	15	TOYO-15P10	27	VO-KP	25
HY-11P4C1	25	MAU-4D	13	RE-6D	15	TOYO-40	28	WIL-23	20
HY-18P1C1	25	MAU-5D	13	RO-29D WINDCOLOR	15	TOYO-40D	28	WIL-66D	20
HY-19DP5	26	MCM-15E8	13	RO-43	15	TOYO-41P	28	YA-280D	20
HY-19P5	26	MCM-45	13	RO-44D	15	TRI-9DSP	18	YA-281D	20
HY-20P	26	MED-1D	13	RO-45	15	TRL-17	18	YA-282	20
IF-10D	11	MEG-1D	13	RO-46	15	TRL-3	18, 28	YA-283D	20
IF-7	10	MERI-1DP1	26	ROD-1	15	TRL-3D	18, 28	YA-300D	20
IF-8	10	MERI-1P1	26	ROD-1D	15	TRL-4P	28	YA-306	20
IF-9	10	MERI-2DP	26	RSS-3	16	TRL-5P	18	YAMA-25P	28
IS-21D	11	MH-1	13	RSS-3D	16	TRL-6	18	YAMA-32DP	28
IS-3D WINDCOLOR	11	MH-2D	13	RU-1	16	TRL-6D	18	YAMA-33P1	28
ISU-3DP1	26	MIT-8DP2	26	RU-1D WINDCOLOR	16	TRP-2	28	YAMA-34	28
ITO-3D	11	MLM-8	13	SA-5D	16	TV-34	18	YAMA-34D	28
JP-1	35	MLM-9	13	SEA-2	16	TV-35	18	YAR-4D	21
JP-2	35	MOI-4G	36	SEL-1	37	TV-36	18	YET-18	21
JP-3	35	MOI-5G	36	STN-1D	16	TV-37	19	YET-19D	21
JP-4	35	MQ-2	12	SUZU-8IP	27	TV-38	19	YUH-3D	21
JP-5	36	MT-17P1G	36	SUZU-12P	27	TV-39	18	ZA-7DP1	29
JP-6	36	MT-1P	13	SUZU-21P	27	TV-40D	18	ZA-9P2	29
KA-7 WINDCOLOR	11	MT-2D	13	SWL-1	16	TV-41	18	ZE-160D	11
KE-6	11	MT-2DP	13	TC-3	16	TX-12	19		

MARCA / BRAND	PAG.
101	32
716	32
ABLOY	1
ABUS	1,2,3,5,14,24
AGA	2
AMIG	2
APRILIA	29
ASSA	2
ATLAS	2
AXA	2,6,24
AZBE	2
BAB	2
BAODELI	2
BEFA	20
BETA	29
BIFFAR	17,20
BKS	3
BMB	3
BMV	29
BODA	5
BRABANTIA	7
BRICARD	3,11,32
BRISANT	3
BUFFO	1,2,24
BURG	3,4
BURG WACHTER	4
BWS	6
CAIB	14
CANADA POST	4
CARL F	4
CAYS	4
CEM	12
CES	5
CIBOX	3
CISA	1,5
CITROEN	28
CLASS	32,33
CORBIN	5,6,7
CORONA	11
CVL	6
DACIA	24
DAEWOO	27
DEBEAURAIN-ND	33
DEKABA	6
DELTA	6
DENY	33
DIERRE	6
DIFA	16
DINBOX	6
DOM	6,7,13
DONNER	11
ELBOR	33
ELCA	7
ELZETT	7
ESAFE	17,19
ESP	7
ET. POWER	16
EURO BOX	7
EURO LOCKS	7,12,15,24
EUROPROFIL	7

MARCA / BRAND	PAG.
EUROSPEC	19,33
EVERGOOD	7
EVVA	7
EZCURRA	7,16,34
FAC	8
FAINER	8
FAS	34
FAVOUR	8
FCV	8
FEDERAL	3
FERONERIA	8
FF	8
FICHET	17,34
FINA	14
FKS	7,12,18
FORD	24
FORT	11
FTH	8,16
FULTON HITCH	8
G.M.	27
GAD	8,24
GUARDIAN	34
GE GE	7,9
GERA	9
GERDA	5,7,9
GERION	34, 35
GEVY	9,13
GODREJ	9
GUARD	9
GUARDIAN	34
GUSHENG	10
HÄFELE	10
HAHN & KOLB	10
HASLER	16
HEKNA	10
HERACLES	17
HFM	10
HOBBY	24
HOBES	35
HOPPE	3
HOK	10
HUDSON	10
HUF	24,25
HUGO	10
HYMER	24
HYUNDAI	25,26
IFAM	10,11
IKON	11
ILARGI	4
ISEO	11
ISEO SILVER	11
ISUZU	26
ITO	11
JOLI SAFE	19
JORE	20
JPM	35,36
KABA	11
KAWASAKI	27
KESO	11
KFV	8

MARCA / BRAND	PAG.
KIA	25,26
KIND	3
KTM	26
KUBOTA	26
KWIKSET	11
LASBOLAGET	11
LAPERCHE	36
LEHMANN	13
LEXUS	27
LINCE	11
LOB	12,21
LOWE & FLETCHER	7,12
MAFOR	36
MAHINDRA RENAULT	26
MARQUES	12
MARS	7
MAUER	6,12,13
MAZDA	27
MCM	13
MEDOS	13
MEGA	10,13
MERIT LINDE	26
METALCASTELLI	10
MHA	13
MINIBUS	26
MLM	13
MOIA	36
MOREAUX	6
MOTTURA	9,13,36,37
MUEL	14
NEIMAN	25,27
NEMEF	5,14
NISSAN	27
OJMAR	14
OMEC	14
OMR	36
OPEL-CHEVROLET	25
ORDO	13
PETCO	11
PFAFFENHAIN	14,15
POTENT	15,37
PREFER	15
PUCH	28
RAUCO	10
REGENT	10
REMOCON	19
RENZ	15
RODES	15
RONIS	15,16
ROTO	3
RUKO	16
RUSSIA	16
SAMSONITE	16
SANTOS	14
SCHRITT	11
SEA	16
SELECT	37
SHAW WALKER	16
SHERLOCK	9
SIB	4

MARCA / BRAND	PAG.
SIL	8,19
STANDERS	16
STARRY LOCK	16
STHALEX	16
STORWALL	16
STUV	6,13,15
STS	7,17
STV	13
SUZUKI	27
TECHNO	16
TECON	16
TESA	16,17
THIRARD	8
TITAN	17,19
TOK WINKHAUS	17
TOKAJ RIKA	27,28
THIRARD	8
THOMAS LAIDLAW	16
TOPLOCK	13,17
TOUCH	18
TOVER	18
TOYOTA	27,28
TRELOCK	18,28
TRI CIRCLE	18
TRIO-VING	18,19
TRIUMPH MOTOR-CYCLE	28
TROMER	18
TRW-SIPEA	28
TRYBA	7
TSC	7
UCEM	17,19
ULTION	3
ULTRA	12
UNION	12
UNIVERSAL	19,20
VACHETTE	11,20,28,37
VALEO	28
VARIOS	20
VBH	8
VESPA	28
VF (VEROFER)	8
VIDMAR	16
VOLKSWAGEN	25
WEDO	7
WILKA	20
WIGRO	20
WINKHAUS	17
WITTE	25
WSS	10,15
WÜRTH	10
YALE	20
YAMAHA	28
YARDENI	21
YEMAR	17
YETI	21
YUN HUAN	21
ZADI	29
ZEISS IKON	11

LLAVES PLANAS PARA CERRADURAS DE CILINDRO

SARRAILA ZILINDRIKOTARAKO GILTZA ZAPALAK

CYLINDER KEYS

CLÉS POUR CYLINDRES

ZYLINDERSCHIÜSSEL



SUPLEMENTO-SUPPLEMENT
C.11 2020

THE KEY TO EXCELLENCE
GLOBALLY UNLOCKING MILLIONS OF DOORS DAILY

ABLOY

ABUS

PARA-FOR:

ABLOY (SF)

ABUS (D)

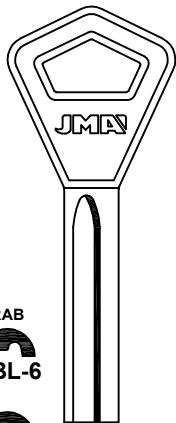

RAB
ABL-6

ABL-4

C
ABL-3

ABL-3D
NEW

LAT.

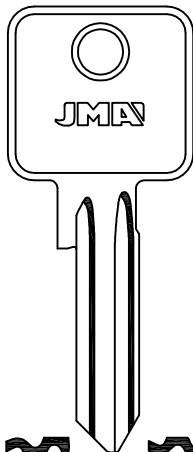

ABU-17
ABU-48

ABU-17D

K1D
ABU-70

ABU-77

ABU-80

ABU-83

X4S
* ABU-85

C83
ABU-100 **NEW**

* LAT.

CISA

ABU-58D

ABU-70D
NEW

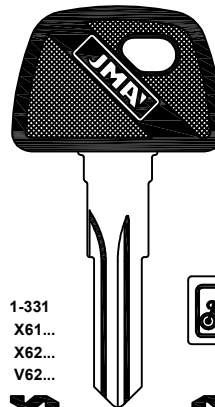

1-331
X61...
X62...
V62...

ABU-35.P

ABU-35D.P
NEW

1-331
V61...
V62...

ABU-36.P

BUFFO

ABUS

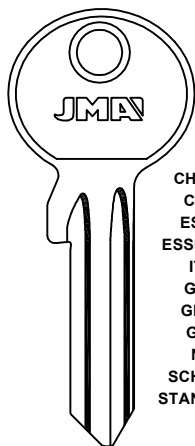

CHAVO
CISA
ESCO
ESSENDIA
ITO
GEFI
GETE
GTV
NB
SCHUCO
STANDARD

ABU-41

ABU-41D

ABU-68

ABU-92
NEW

ABU-92D
NEW

ABU-99D/1
NEW

ABU-99D/2
NEW

ABU-99D/3
NEW

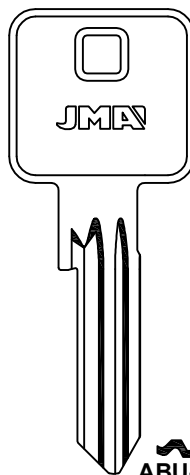

ABU-86D

E60
ABU-94D
NEW

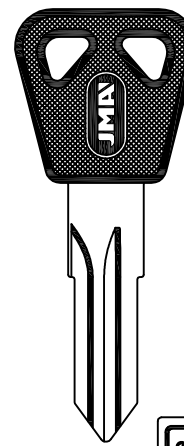

NW52
ABU-87.P
NEW

ABUS

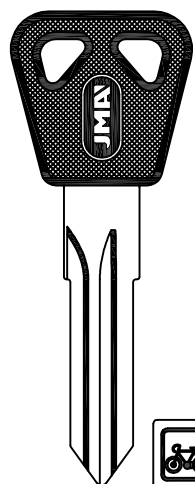

NW72
ABU-88.P
NEW

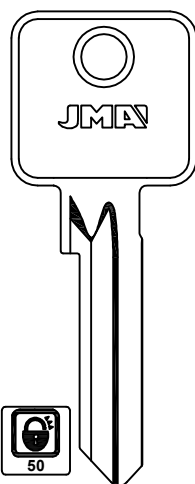

SERIE 90/50
ABU-89D
NEW

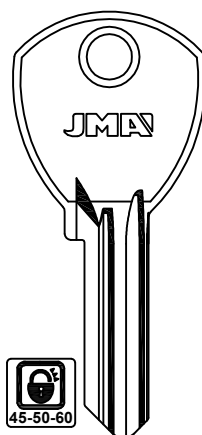

SERIE 64TI
ABU-90
NEW

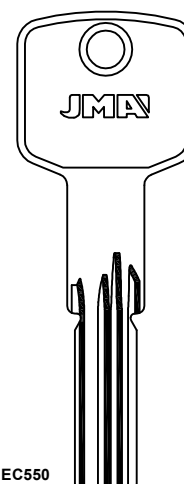











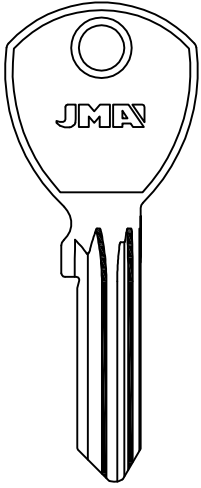
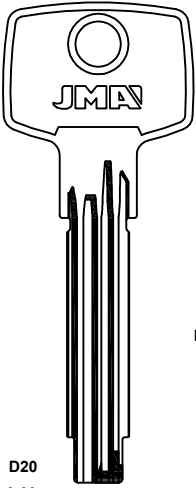
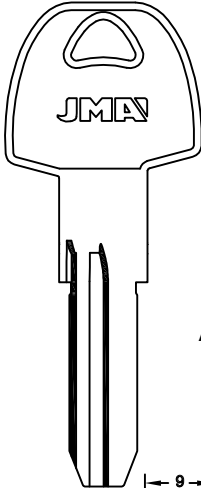
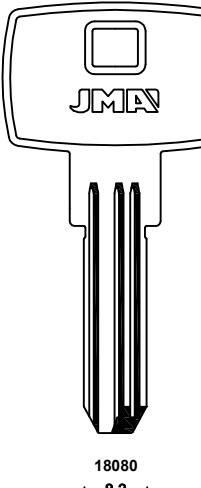

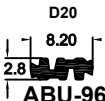
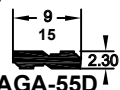
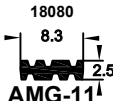
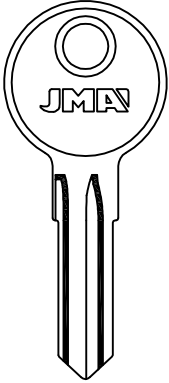
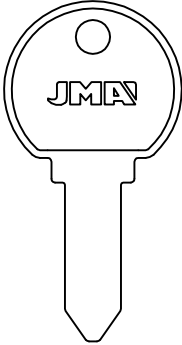
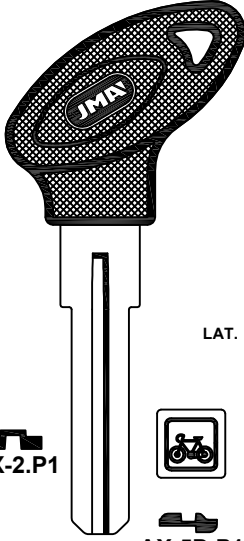
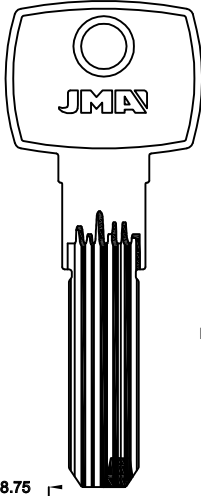



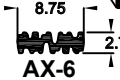
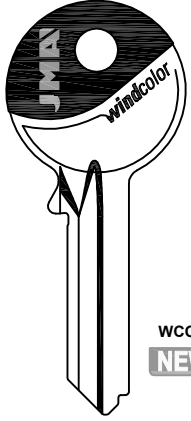
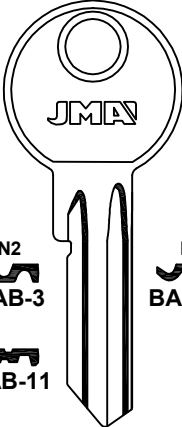

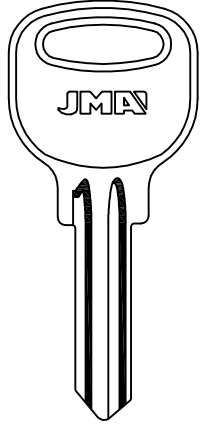







EC550
8.2
2.8
ABU-91
NEW

LAT.



PARA-FOR:

- ABUS (D)
- AGA (E)
- AMIG (E)
- ASSA (S)
- ATLAS (USA)
- AXA (S)
- AZBE (E)
- BAB (D)
- BAODELI (TJ)

ABUS		AGA		AMIG	
				LAT.	LAT.
 ABU-93 NEW	 D20 8.20 2.8 ABU-96 NEW	 9 15 2.30 AGA-55D NEW	 18080 8.3 2.5 AMG-11 NEW		
ASSA		ATLAS		AXA	
				LAT.	LAT.
 AS-30D NEW	 AL ATL-1 NEW	 AX-2.P1  AX-5D.P1 BUFFO NEW	 8.75 2.75 AX-6 NEW		
AZBE		BAB		BAODELI	
		 206 BAB-13/1 NEW	 209 BAB-13/2 NEW		
 WCOLOR NEW AZ-37D	 N2 BAB-3  BAB-11  BAB-12D  BAB-20D/2 NEW	 307 BAB-13/3 NEW  406 BAB-13/5 NEW  BAB-13/7 NEW  BAB-13/9 NEW  BAB-13/11 NEW	 210 BAB-13/4 NEW  407 BAB-13/6 NEW  510 BAB-13/8 NEW  BAB-13/10 NEW  310 BAB-13/12 NEW	 BAO-1 NEW	 BAO-1D NEW



BKS

PARA-FOR:

- BKS (D)
- BMB (D)
- BRICARD (F)
- BRISANT (GB)
- BURG (D)

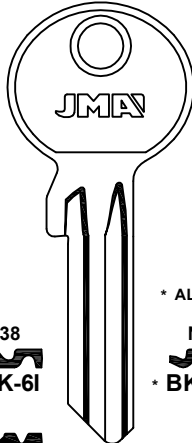

38
BK-6I

BK-22
NEW

BK-23
NEW

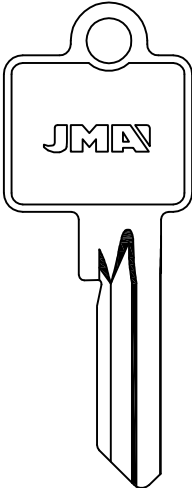

* ALU.
NA
* BK-6D

BK-21/1	NEW	BK-21/8	NEW	SE BK-26/125
BK-21/2		BK-21/9	NEW	SE BK-26/135
NEW BK-21/3	NEW	BK-21/10	NEW	SE BK-26/145
NEW BK-21/4		BK-21/14	NEW	SE BK-26/235
NEW BK-21/5	NEW	BK-21/16	NEW	SE BK-26/237
NEW BK-21/6		BK-21/17	NEW	SE BK-26/245
NA BK-7D		BK-21/19	NEW	SE BK-26/246

BKS

BMB

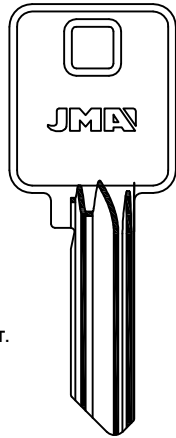

* LAT.

BK-16
NEW

* BK-16/7	* BK-16/16	BK-16/30
* BK-16/5	* BK-16/15	* BK-16/23
* BK-16/4	* BK-16/14	* BK-16/21
* BK-16/3	* BK-16/13	* BK-16/20
* BK-16/2	* BK-16/11	NEW * BK-16/19
* BK-16/1	* BK-16/10	* BK-16/18
* BK-16/0	* BK-16/9	* BK-16/17

SERIE 2000

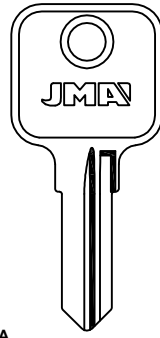

A
BMB-1

BMB-3
NEW

M
BMB-3D

A...201-400
BMB-4
NEW

SERIE 2000

BMB

BRICARD

BRISANT

BURG



BMB-5
NEW



WCOLOR
NEW

BRI-19
ABUS



LAT.

BRN-2D
NEW

NEW
2.95
BRN-1D

ULTION - FEDERAL



BUR-10

BUR-10D

BUR-38
NEW

CIBOX-HOPPE-KIND-ROTO



PARA-FOR:

BURG (D)

CANADA POST
(CDN)

CARL F (GB)

CAYS (E)

BURG

BUR-14 **BUR-14D** **BUR-19D** **BUR-37D** **BUR-33** **BUR-43** **BUR-35D** **BUR-36** **BUR-36D**

BOCCIA 450 8.15 2.65
BOCCIA 450 2.85

BURG WACHTER **BURG WATCHER**

BURG

BUR-39 **BUR-39D** **BUR-40D** **BUR-41** **BUR-42D**

BOCCIA 450 8.8 2.9

BURG WACHTER **BURG WACHTER** **BURG-WACHTER**

CANADA POST

CARL F

CAYS

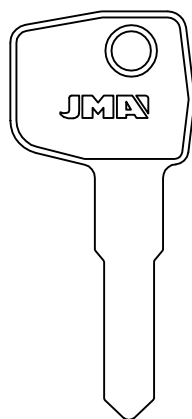

CNP-2D
NEW

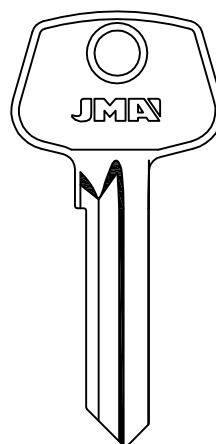

CRF-1D
NEW

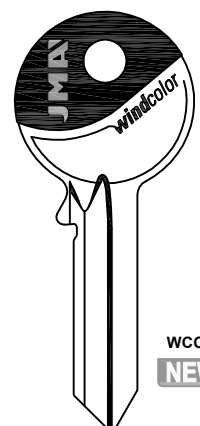

CAY-1D

ILARGI-SIB



CES

PARA-FOR:

CES (D)

CISA (I)

CORBIN (I)

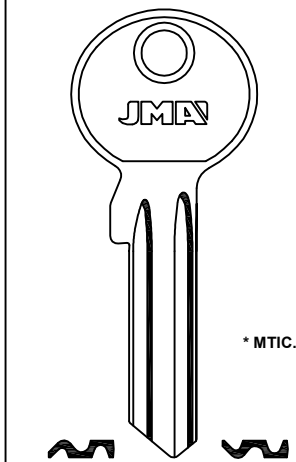

CE-71

* MTIC.

CE-136D/1 NEW

CE-136D/2 NEW

CE-136D/4 NEW

CE-136D/5 NEW

* CE-7D

CE-8D

CE-50

CE-51

CE-51D

CE-55

CE-56

CE-57

CE-77

CE-78

CE-79

CE-80

CE-81

CE-82

CE-83

CE-84

CE-85

CE-86

CE-87

CE-88

CE-91 NEW

12...1-100000

33 mm.

* LAT.

NEMEF

BODA

CISA

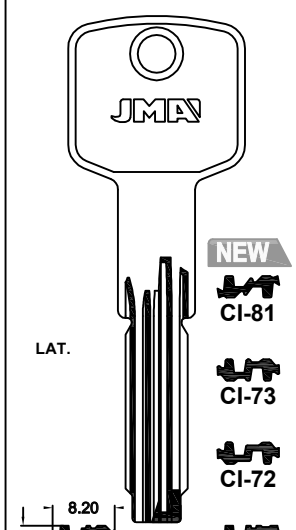

LAT.

CI-81

CI-73

CI-72

CI-71

CI-48

CI-48.P

CI-77.P NEW

CI-76.P NEW

CI-75.P NEW

CI-73.P NEW

CI-72.P NEW

CI-71.P NEW

CI-84.P NEW

CI-83.P NEW

CI-82.P NEW

CI-81.P NEW

CI-80.P NEW

CI-79.P NEW

CI-78.P NEW

CI-DL

WCOLOR NEW

8.20

2.85

8.2

2.85

ABUS-GERDA

ABUS

CISA

CORBIN

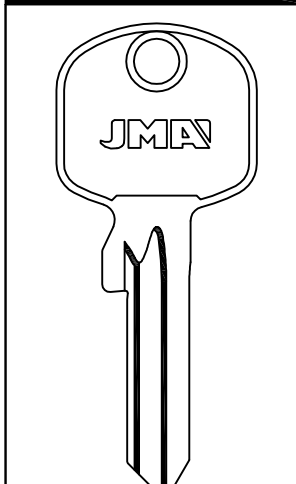

CI-GDL NEW



WCOLOR NEW

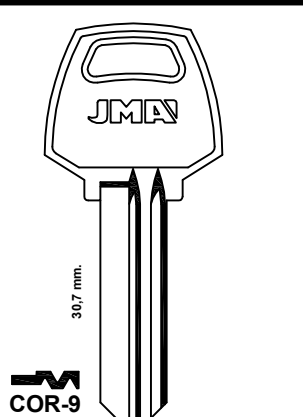

30.7 mm.

COR-9

COR-10

COR-1D

COR-61 NEW

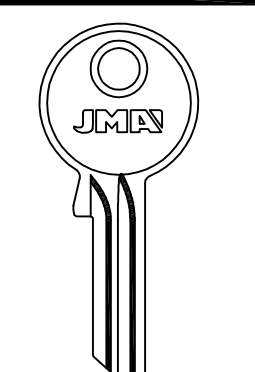

COR-230 NEW











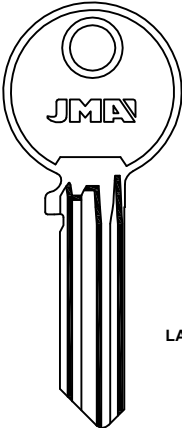
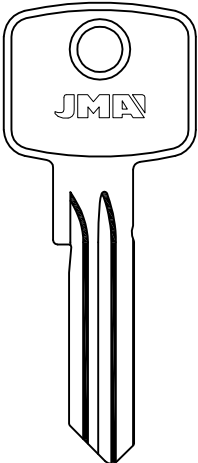
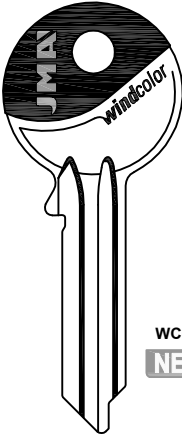

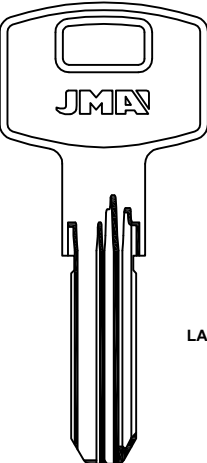
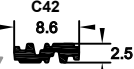
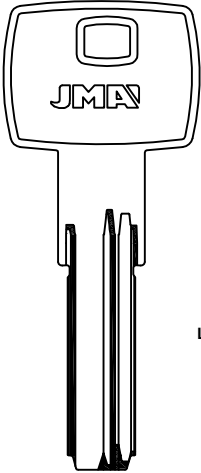
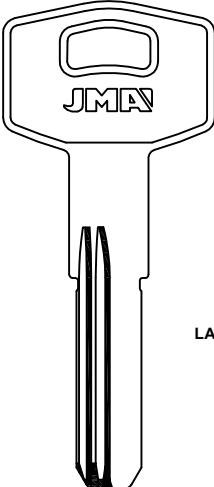
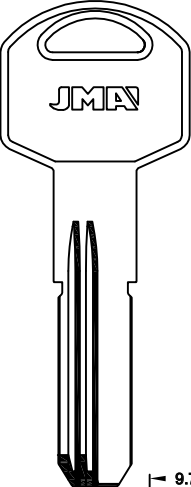
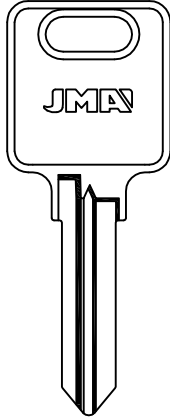
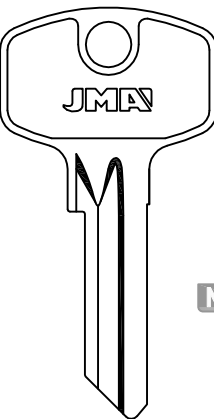

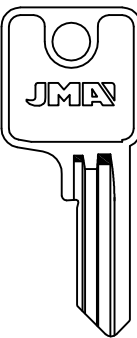
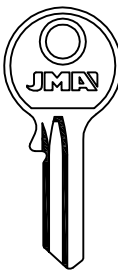
COR-70 NEW

COR-70D







PARA-FOR:



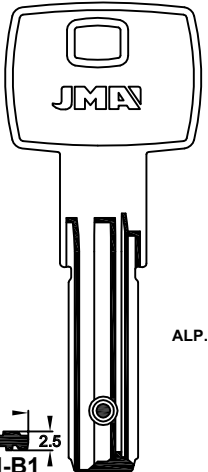
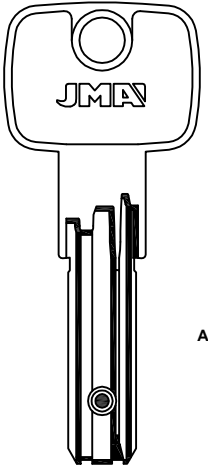
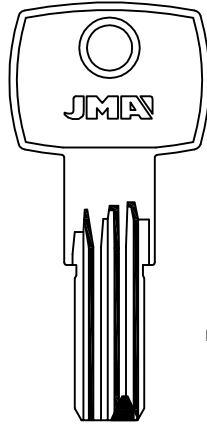
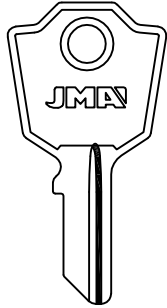
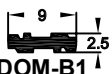
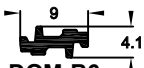
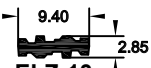





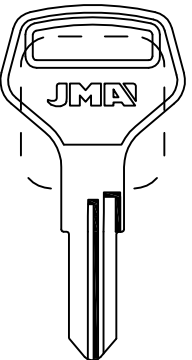
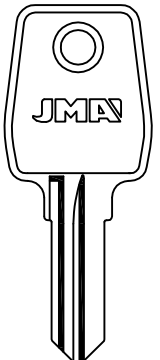
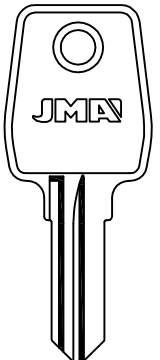

- CORBIN (I)
- CVL (E)
- DEKABA (BG)
- DELTA (GB)
- DIERRE (I)
- DINBOX (N)
- DOM (D)

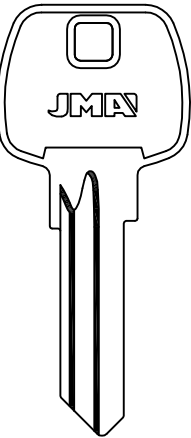
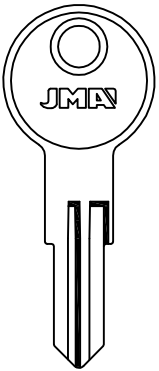









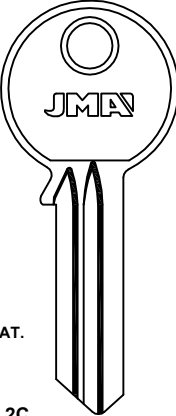





CORBIN		CVL		DEKABA	
					
COR-231 NEW	COR-232D NEW	CVL-5I	CVL-5D	DEK-16 NEW	
BWS		WCOLOR NEW		MAUER-AXA	
CORBIN		CORBIN		CORBIN	
					
DEK-17 NEW	DLT-1D NEW	DR-2D NEW	DBX-1D NEW		
CORBIN		CORBIN		CORBIN	
DOM					
					
DOM-21D	DOM-45	DOM-44D	DOM-25D	DOM-77D NEW	
					
DOM-2D	DOM-75 NEW	DOM-46D	DOM-49D	DOM-80 NEW	
					
DOM-80 NEW	DOM-78D NEW	DOM-80D NEW	DOM-76D NEW	DOM-80D NEW	
MOREAUX-STUV-CORBIN					

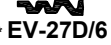

DOM		ELZETT		ESP	
					
ALP.	ALP.	LAT.			
					
DOM-B1	DOM-B2	ELZ-13			
					
NEW CORBIN-STS	NEW	NEW			
					
			NEW ESP-4D		
			FKS		

PARA-FOR:
 DOM (D)
 ELZETT (H)
 ESP (USA)
 EURO BOX
 EUROLOCKS (B)
 EURO-PROFIL (PL)
 EVERGOOD (RC)
 EVVA (A)
 EZCURRA (E)

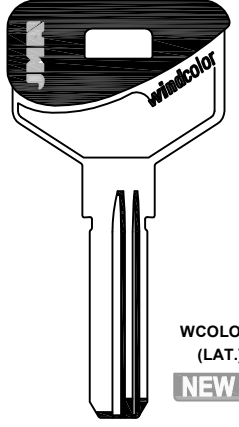









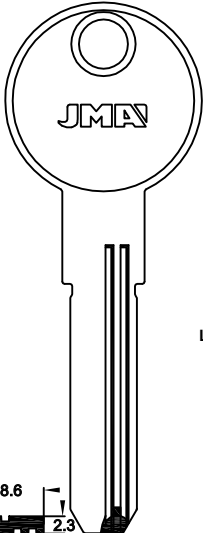

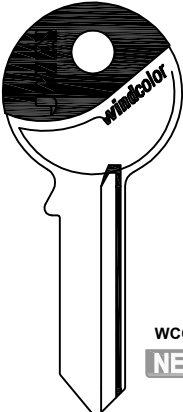

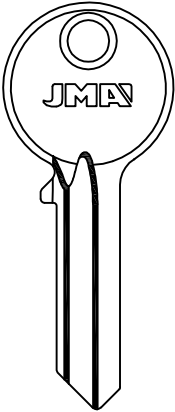

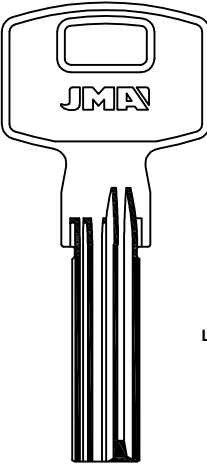

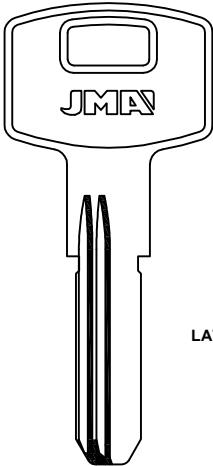

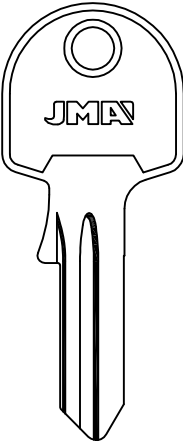
EURO BOX		EUROLOCKS		EURO-PROFIL		EVERGOOD	
							
		KB 1-500	L&F	GERDA			
							
EUB-2	EUB-2D	EU-17	EU-8D	EUP-4D	EVE-2	EVE-2D	
BRABANTIA-MARS-WEDO				NEW	NEW		

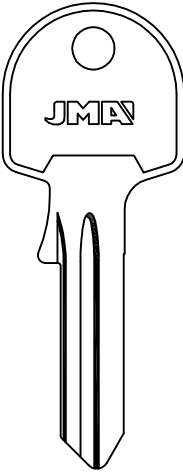
EVVA				EZCURRA	
					
* LAT.					5CF
					
2C				* EV-27D/5	NEW
EV-21	EV-15D	* EV-14	EV-23D	* EV-27D/4	EV-29D/0
NEW				* EV-27D/3	NEW
2F				* EV-27D/2	EV-28D/0
EV-31	* EV-25D	EV-23D	* EV-27D/1	* EV-27D/10	NEW
					EV-27D/9
					EV-27D/8
ELCA		ELCA-TRYBA-GE GE-EVVA-TSC			
					WCOLOR (LAT.)
					NEW
					
				EZ-DS15R	

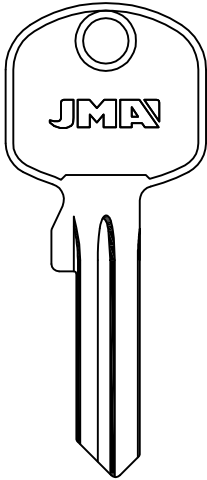

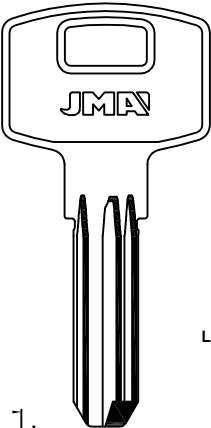
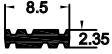
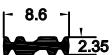
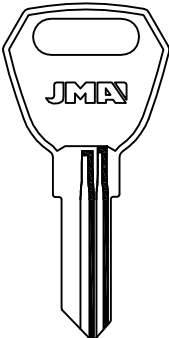
PARA-FOR:

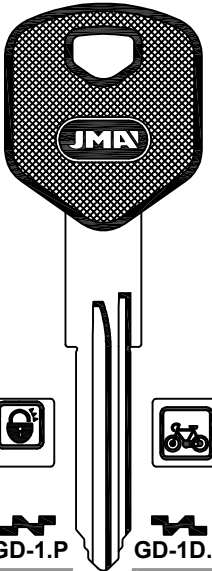
- FAC (E)
- FAINER (P)
- FAVOUR (DZ)
- FCV (D)
- FERONERIA (RU)
- F.F. (I)
- FTH (F)
- FULTON HITCH (GB)
- GAD (NL)

FAC	FAINER	FAVOUR	FCV
 <p>LAT.</p>  <p>FAC-25 NEW</p>	 <p>Wincolor</p> <p>WCOLOR NEW</p>  <p>FAIN-1</p> <p>SIL</p>	 <p>JMA</p>  <p>FAV-3 NEW</p>  <p>FAV-3D NEW</p>	 <p>JMA</p> <p>LAT.</p>  <p>FV-3 NEW</p> <p>KFV-VBH</p>
FERONERIA			F.F.
 <p>LAT.</p>  <p>FER-2D NEW</p>	 <p>JMA</p>  <p>FER-3D NEW</p> <p>VF (VEROFER)</p>	 <p>JMA</p>  <p>FER-4D NEW</p>	 <p>JMA</p>  <p>FF-10GD NEW</p>
FTH	FULTON HITCH		GAD
 <p>LAT.</p>  <p>FTH-25</p>  <p>FTH-30 NEW</p> <p>THIRARD</p>	 <p>JMA</p> <p>LAT.</p>  <p>FLT-1 NEW</p>  <p>FLT-1D NEW</p>	 <p>JMA</p>  <p>GD-1.P NEW</p>  <p>GD-1D.P NEW</p>	



GE GE

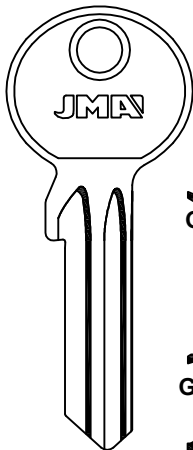

PARA-FOR:

- GE GE (A)
- GERA (D)
- GERDA (PL)
- GEVY (GR)
- GODREJ (IND)
- GUARD (HK)

GERA

GERDA

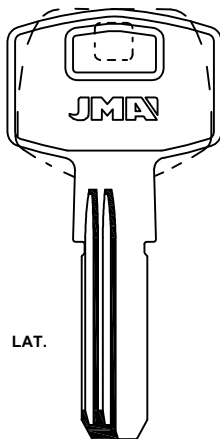
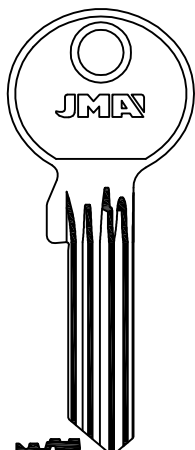

LAT.

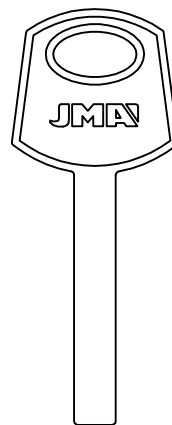
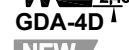

GEVY

GODREJ

GUARD

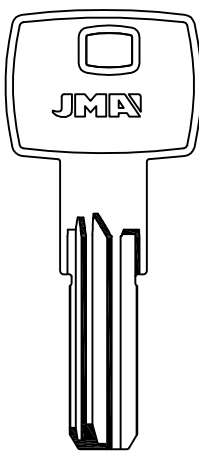

LAT.



MOTTURA

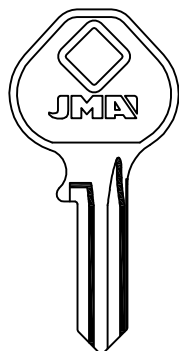



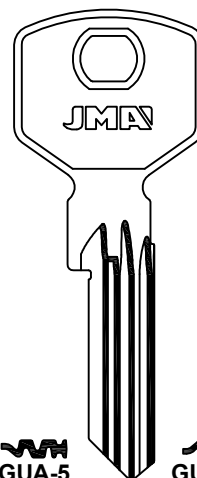
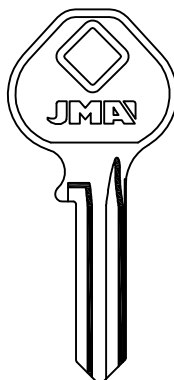





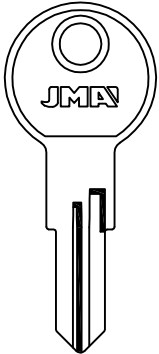

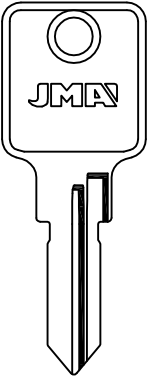

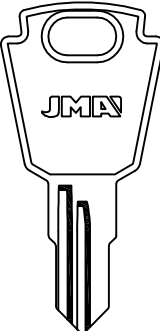

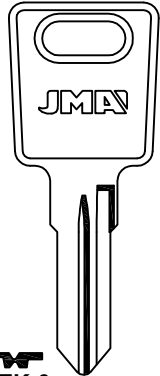



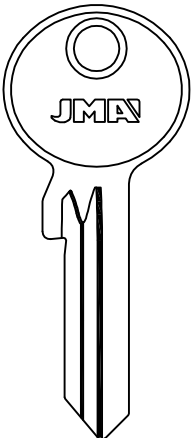

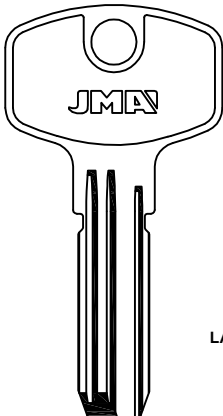

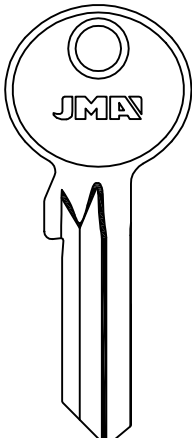
SHERLOCK

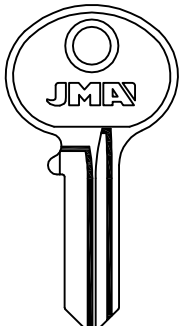

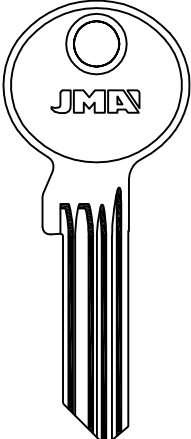
PARA-FOR:

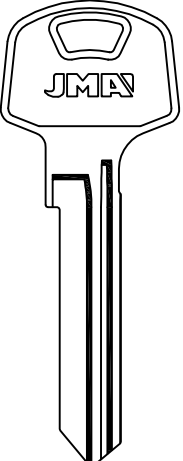
- GUSHENG (D)
- HÄFELE (D)
- HAHN&KOLB (D)
- HEKNA (D)
- HFM (D)
- HOK (TR)
- HUDSON (USA)
- HUGO (D)
- IFAM (E)

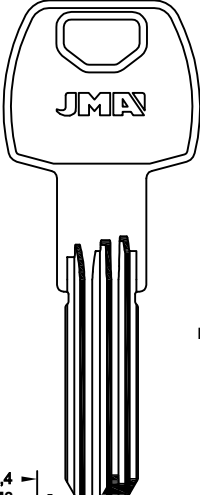
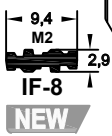
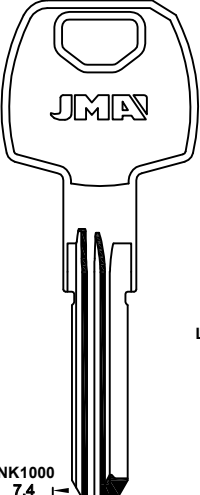
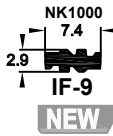
GUSHENG	HÄFELE	HAHN&KOLB	HEKNA
  GUS-1 NEW	  HAF-6 NEW <small>WSS-WÜRTH</small>	  HKO-1D NEW	  HEK-6 NEW  HEK-5 NEW <small>...1501-1540</small>  HEK-4  HEK-4D NEW <small>METALCASTELLI-RAUCO-REGENT</small>
HFM	HOK		HUDSON
  HF-1D NEW	  <small>9.20 2.50</small> HOK-1D NEW <small>MEGA</small>	  HOK-2D NEW	  <small>... 01-175</small> HUD-3  HUD-3D NEW
HUGO	IFAM		
  HGO-1 NEW	  IF-7 NEW	  <small>9,4 M2 2,9</small> IF-8 NEW	  <small>NK1000 7,4 2,9</small> IF-9 NEW

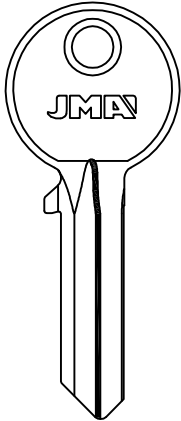
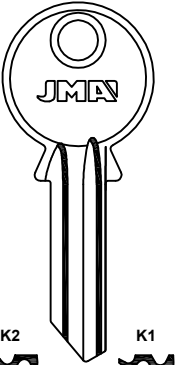
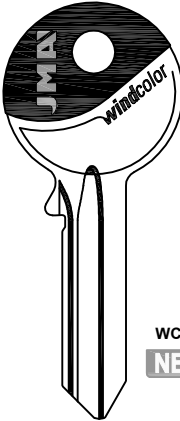
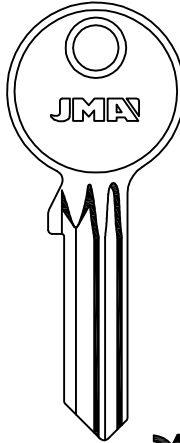

IFAM	IKON	ISEO	
 <p>F5S IF-10D NEW</p>	 <p>K2 ZE-K2 K1 ZE-K1 K6 ZE-K6 K5 ZE-K5 NEW ZE-160D CORONA-FORT-SCHRITT-ZEISS IKON</p>	 <p>WCOLOR NEW F5 IS-3D</p>	 <p>F3 IS-15 IS-21D NEW ISEO SILVER</p>

PARA-FOR:
 IFAM (E)
 IKON (D)
 ISEO (I)
 ITO (TR)
 KABA (CH)
 KESO (CH)
 KWIKSET (USA)
 LINCE (E)

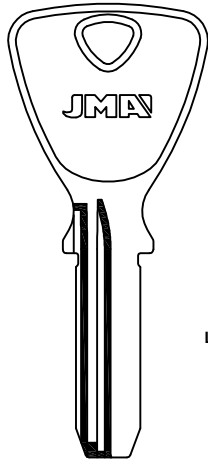
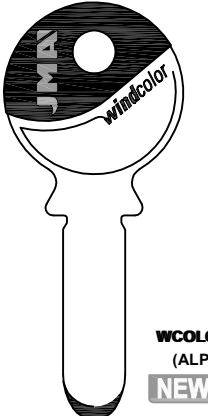
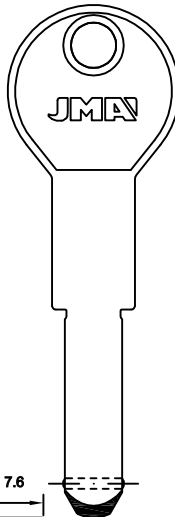
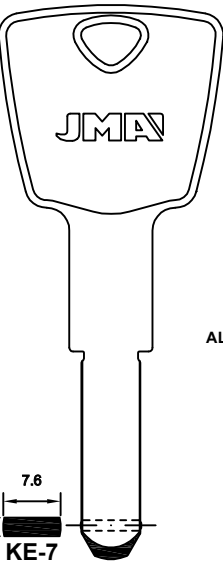
ITO	KABA	KESO	
 <p>LAT. 8.5 2.4 ITO-3D NEW</p>	 <p>WCOLOR (ALP.) NEW 7.85 8 1.95 KA-7 LÅSBOLAGET</p>	 <p>ALP. 7.6 2.46 KE-6 NEW</p>	 <p>ALP. 7.6 2.45 KE-7 NEW</p>

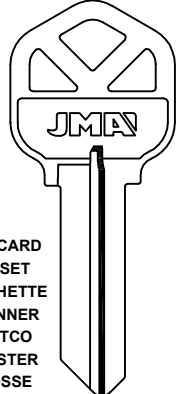
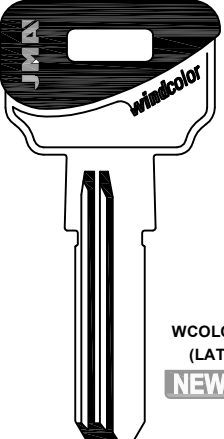
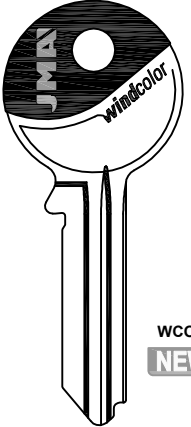
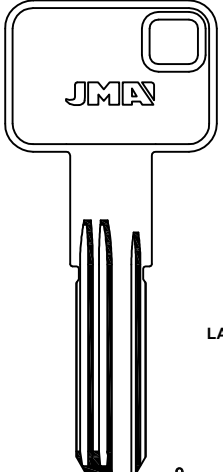
KWIKSET	LINCE		
 <p>BRICARD EZSET VACHETTE DONNER PETCO MASTER POSSE 1 AL 7 KWI-1K NEW</p>	 <p>WCOLOR (LAT.) NEW 9 2.45 LIN-21D</p>	 <p>WCOLOR NEW R LIN-25D</p>	 <p>LAT. 9 2.4 C6 LIN-26D NEW</p>



PARA-FOR:

- LOB (PL)
- L&F (GB)
- MARQUES (P)
- MAUER (NL)

LOB

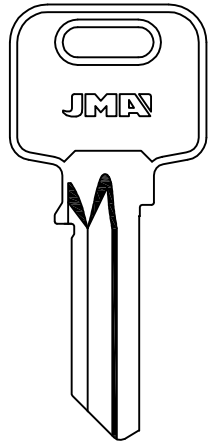

LB-2MD
NEW

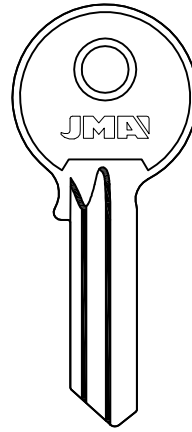

LB-5D
NEW

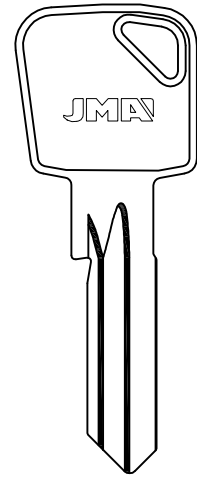

LB-6D
NEW

LOWE&FLETCHER

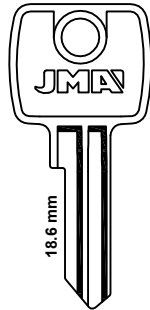

LF-15
FFE
001-100
LF-17



- 60... 001-200
- 60... 001-200
- 90... 001-200
- ...1-400
- GHM...1-155
- M...1-400
- RV...1-400
- RVM...1-400
- SP...1-400
- 99...1-400

LF-15D

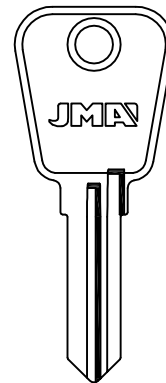

LF-41

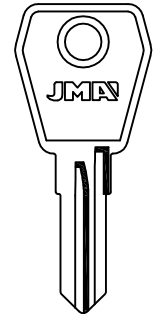

LF-46

NEW **LF-47**

CEM-EURO LOCKS-ULTRA-UNION

NEW **LF-51**

FKS

LF-50D
NEW

MARQUES

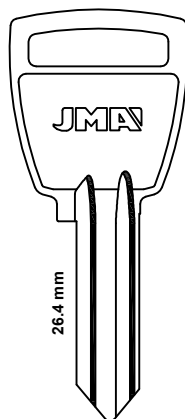

MQ-2
NEW

MAUER

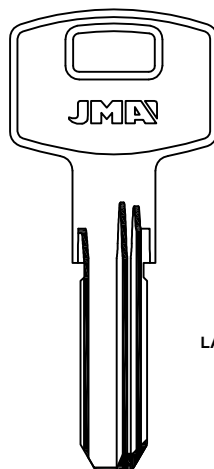

8.6
E2
2.5
MAU-1
NEW

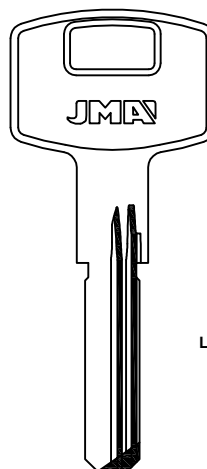

7.2
2.5
MAU-2
NEW

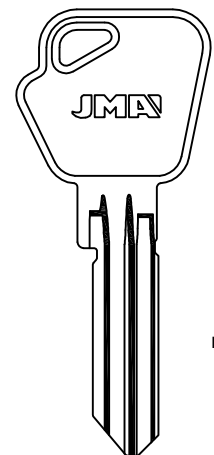

MAU-3D
NEW

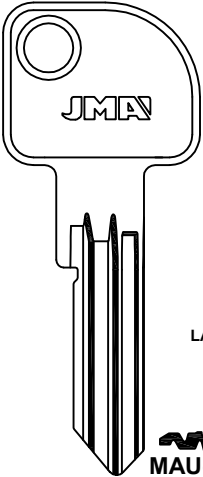
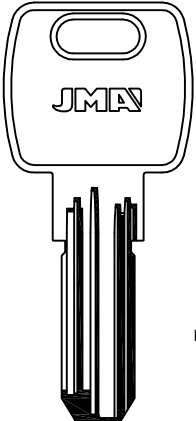
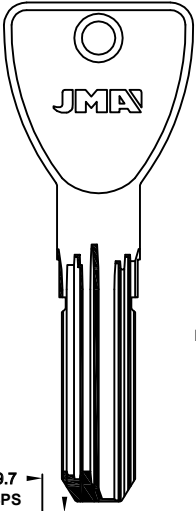
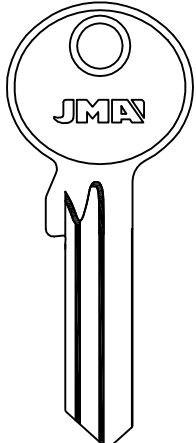

MAUER	MCM		MEDOS
 <p>LAT.</p> <p>MAU-5D NEW</p> <p>MAU-4D NEW</p>	 <p>LAT.</p> <p>9.7 E8 2.8</p> <p>MCM-15E8 NEW</p>	 <p>LAT.</p> <p>9.7 BPS 2.8</p> <p>MCM-45 NEW</p>	 <p>LAT.</p> <p>MED-1D NEW</p>

PARA-FOR:
 MAUER (NL)
 MCM (E)
 MEDOS (PL)
 MEGA (RU)
 MHA (TJ)
 MLM (D)
 MOTTURA (I)

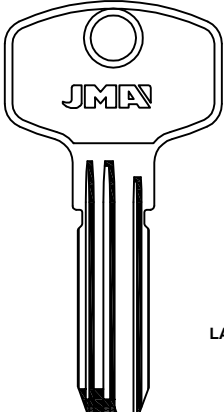
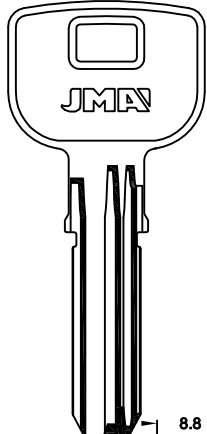
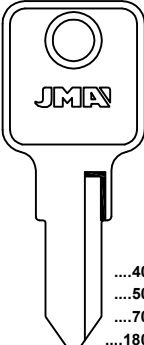
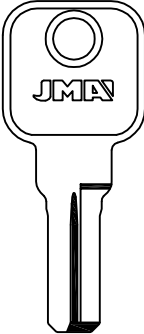

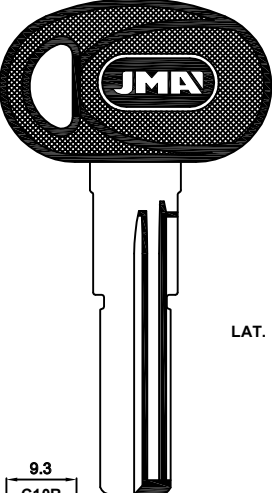
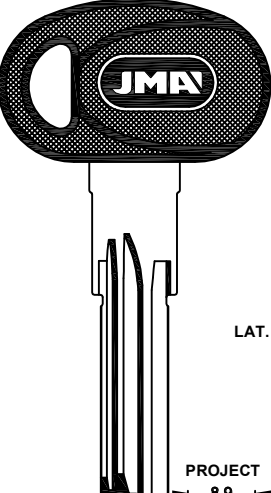
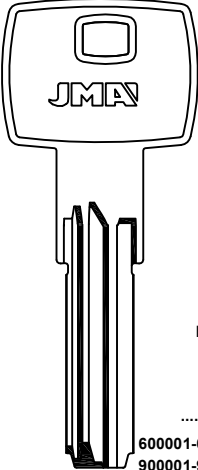

MEGA	MHA	MLM	
 <p>LAT.</p> <p>9.2 2.5</p> <p>MEG-1D NEW</p>	 <p>LAT.</p> <p>8.8 2.35 2.75</p> <p>MH-2D NEW</p> <p>MH-1 NEW TOP LOCK</p>	 <p>.....4001-4100 5000-5100 7001-7499 18001-18100</p> <p>MLM-2 MLM-5 MLM-5D MLM-9 NEW</p> <p>DOM-LEHMANN-ORDO-STUV</p>	 <p>LAT.</p> <p>MLM-8 NEW</p> <p>LEHMANN</p>



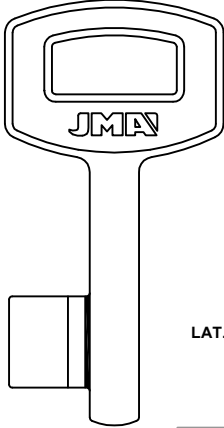

MOTTURA		
 <p>LAT.</p> <p>9.3 C10R 2.85</p> <p>MT-1.P NEW</p>	 <p>LAT.</p> <p>PROJECT 8.9 2.8</p> <p>MT-2D.P NEW</p>	 <p>LAT.</p> <p>..... 600001-613040 900001-902780</p> <p>8.9 2.8</p> <p>MT-2D NEW</p> <p>GEVY- STV</p>

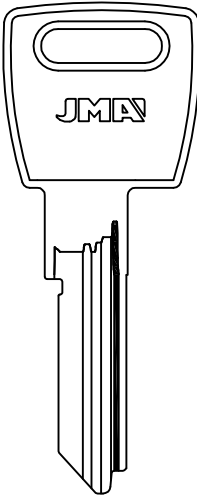



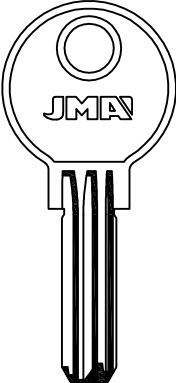
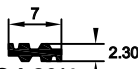

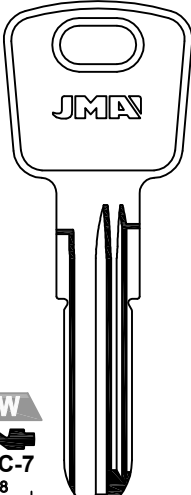



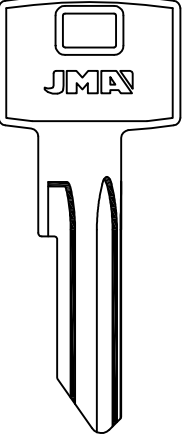



PARA-FOR:









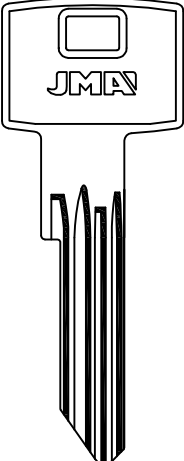

- MUEL (F)
- NEMEF (D)
- OJMAR (E)
- OMEC (I)
- PFAFFENHAIN (D)

MUEL	NEMEF
 <p>LAT.</p> <div style="display: flex; justify-content: center; gap: 20px;"> <div style="text-align: center;">  <p>17.15 3.50 MUE-2</p> </div> <div style="text-align: center;">  <p>MUE-1</p> </div> </div> <p>NEW</p>	 <div style="display: flex; justify-content: center; gap: 20px; margin-top: 20px;"> <div style="text-align: center;"> <p>NF2 N5..... 000001-100962</p>  <p>NEF-4</p> <p>NEW</p> </div> <div style="text-align: center;"> <p>NF3 N5..... 000001-100962</p>  <p>NEF-3</p> <p>NEW</p> </div> </div>





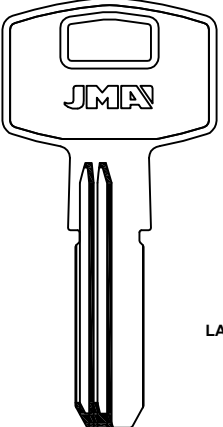
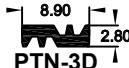
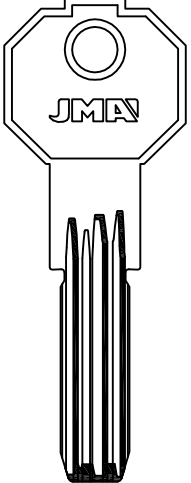
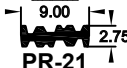

OJMAR	OMEC
 <p>LAT.</p> <div style="display: flex; justify-content: center; gap: 20px; margin-top: 20px;"> <div style="text-align: center;">  <p>7 2.30 OJ-20/4</p> <p>NEW</p> </div> <div style="text-align: center;">  <p>OJ-21D</p> <p>NEW</p> </div> </div>	 <p>LAT.</p> <div style="display: flex; justify-content: center; gap: 20px; margin-top: 20px;"> <div style="text-align: center;">  <p>OMC-7</p> <p>8.8</p> </div> <div style="text-align: center;">  <p>2.6 OMC-3</p> </div> </div> <p>SANTOS-CAIB</p>



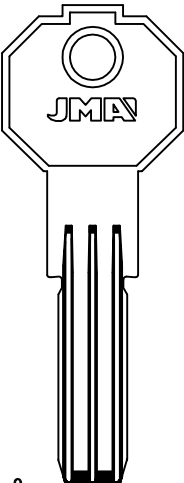
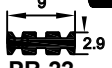
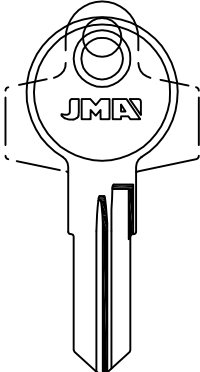

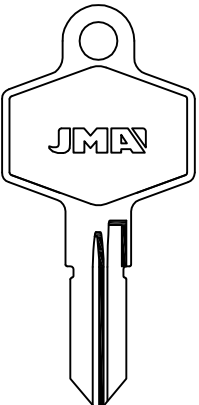

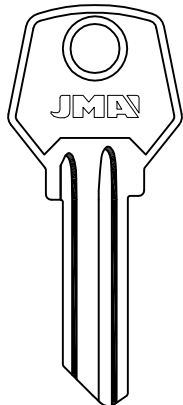

PFAFFENHAIN			
	<p>EA  PFA-13D</p> <p>EB  PFA-14D</p> <p>EH  PFA-15D</p> <p>EN  PFA-16D</p> <p>RF  PFA-17D</p> <p>RG  PFA-18D</p>	<p>A21  PFA-10D</p> <p>A22  PFA-11D</p> <p>A23  PFA-12D</p>	<p>T21 AL T26-T28 T31 AL T42 T44 AL T46 T51-T54-T65 T85-T86-T91 PFA-22</p> <p>A40  PFA-23D NEW</p> <p>FINA A40  PFA-22D ABUS</p>

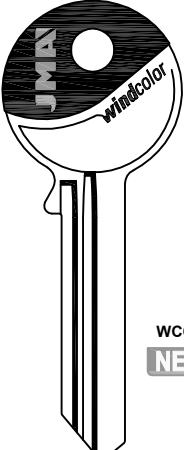

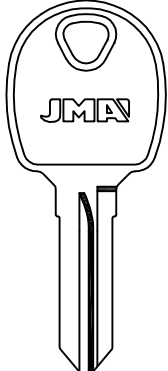
PFAFFENHAIN		POTENT	PREFER
	A21  PFA-7D A22  PFA-8D A23  PFA-9D  PFA-21  PFA-24 NEW  PFA-25 NEW  PFA-24D NEW  PFA-25D NEW  PFA-26D NEW	 LAT.  PTN-3D NEW	 LAT.  PR-21 NEW

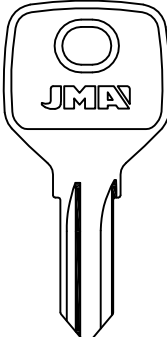
PARA-FOR:
 PFAFFENHAIN (D)
 POTENT (I)
 PREFER (I)
 RENZ (D)
 RODES (I)
 RONIS (F)

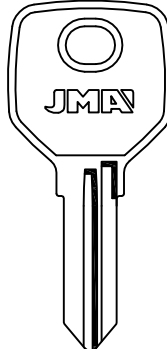

PREFER	RENZ		RODES	
 LAT.  PR-22 NEW	  RE-5 NEW  RE-5D NEW	  RE-6 NEW  RE-6D NEW	  ROD-1 NEW  ROD-1D NEW	

RONIS			
 WCOLOR NEW  RO-29D	  RO-43 NEW  RO-46 NEW	  RO-44D NEW	  RO-45 NEW STUV-WSS

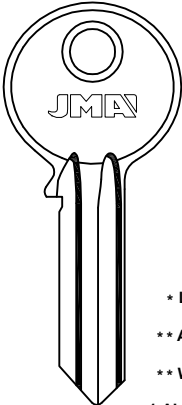

PARA-FOR:

- RUKO (DK)
- RUSSIA (RUS)
- SAMSONITE (USA)
- SEA (CH)
- SAW WALKER (USA)
- STANDERS (E)
- TECHNO (D)
- TECON (E)
- TESA (E)

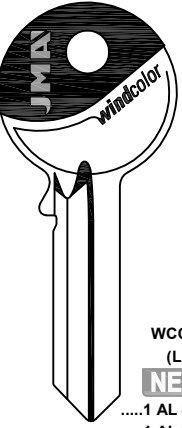
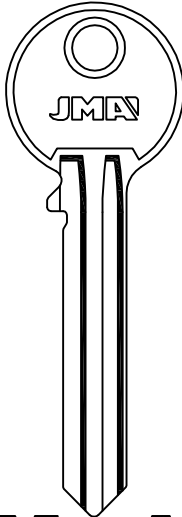
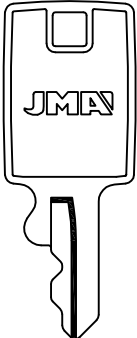
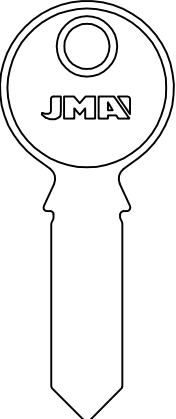
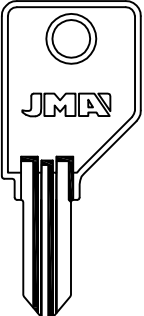
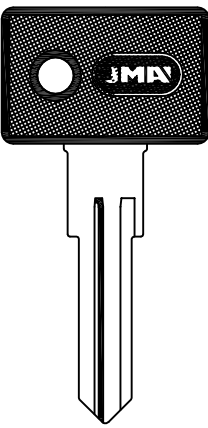
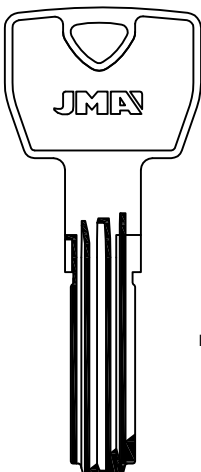
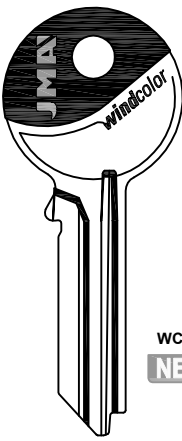
		RUKO		RUSSIA		
		 <p>* LAT. ** ALU. ** WColor</p> <p>.....1 AL 81 AL 91 AL 9 AL 0 A-B0 AL 9 A AL M S.....1 AL 9</p> <p>RU-1 NEW</p> <p>** RU-1D</p>	 <p>RU-2I</p> <p>RU-2D</p> <p>RU-3D</p> <p>RU-4D</p> <p>RU-10D</p> <p>* RU-19D</p> <p>RU-TL</p>	 <p>WColor (LAT.) NEW</p> <p>.....1 AL 81 AL 91 AL 9 AL 0 A-B0 AL 9 A AL M S.....1 AL 9</p> <p>RU-1D</p>	 <p>RSS-3 NEW</p> <p>RSS-3D NEW</p>	
		DIFA		DIFA		
SAMSONITE		SEA		SHAW WALKER		
 <p>SA-5D NEW</p>		 <p>ALP.</p> <p>.....1 AL 7</p> <p>9.4</p> <p>2.2</p> <p>SEA-2 NEW</p> <p>EZCURRA-HASLER-VIDMAR</p>		 <p>LAT.</p> <p>SWL-1 NEW</p> <p>STORWALL</p>		
				LAT.		
				NEW		
				FTH		
TECHNO		TECON		TESA		
 <p>TCH-1.P NEW</p> <p>TCH-1D.P NEW</p>		 <p>LAT.</p> <p>WF 8.3</p> <p>2.8</p> <p>TC-3 NEW</p>		 <p>WColor (LAT.) NEW</p> <p>T..... 0 AL 9</p> <p>TE-8I</p>		
				WColor (LAT.) NEW		
				NEW		
				THOMAS LAIDLAW		
ET.POWER-STARRY LOCK-STHALEX						



TESA

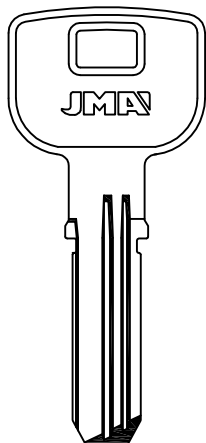

ALP.

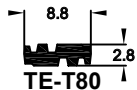

TE-T80



TE-T80EH



TE-T80SC

NEW

ESAFE-ST5-TOPLOCK-YEMAR

TITAN

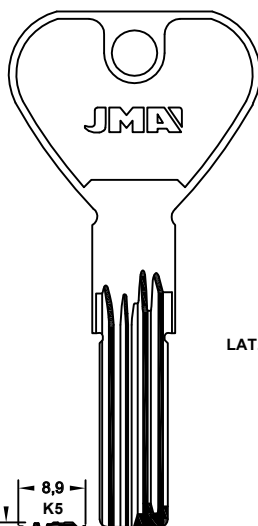

LAT.

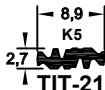

TIT-21

NEW

UCEM

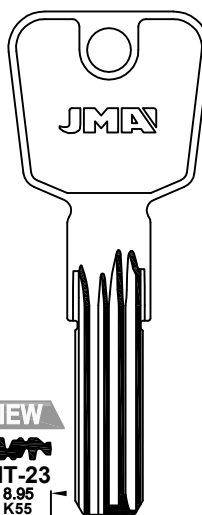

LAT.

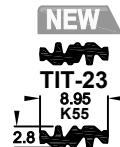

TIT-22

NEW

HERACLES

PARA-FOR:

TESA (E)

TITAN (SLO)

TOK WINKHAUS (D)

TITAN

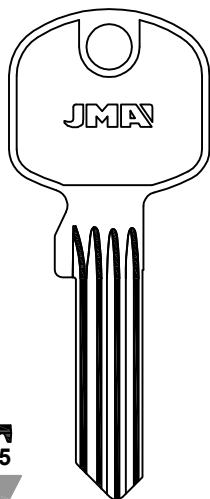

TIT-25

NEW



TIT-24

NEW

TOK WINKHAUS

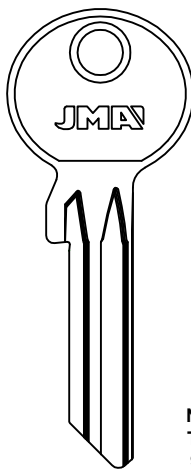

TOK-6

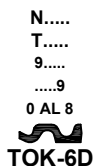

TOK-6D



TOK-83

NEW



TOK-27



TOK-26



TOK-25



TOK-83D

NEW

N.....
T.....
9.....
.....9
0 AL 8

TOK WINKHAUS

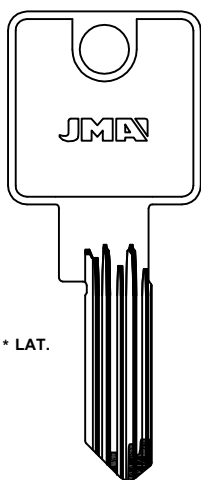

* LAT.



ENAX

TOK-7D



TOK-32



TOK-33



TOK-86D **NEW**



EAFF

TOK-23



TOK-28D



* TOK-85D **NEW**



TOK-15



TOK-16D



* TOK-84D **NEW**



TOK-13D



TOK-14D

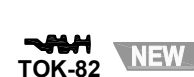

TOK-82 **NEW**



EFAM

EFWS

TOK-11



EWSB

TOK-12



BFA3

* BIF-1



EVB

TOK-88D **NEW**



EHBA

EKCP

TOK-9



FAABF

TOK-10D



TOK-34D





TOK-87D **NEW**

FICHET-BIFFAR-WINKHAUS

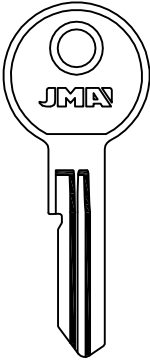

PARA-FOR:

- TOUCH (GB)
- TOVER (E)
- TRELOCK (D)
- TRI-CIRCLE (RC)
- TRIO-VING (N)

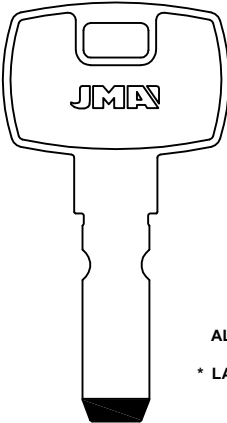
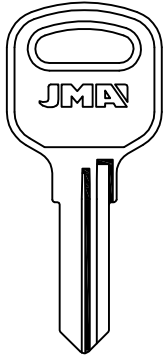
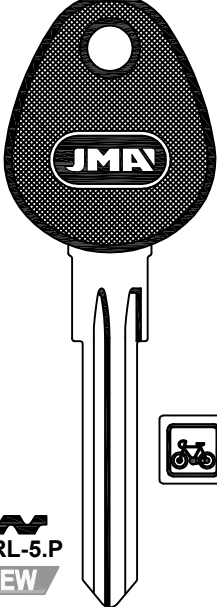
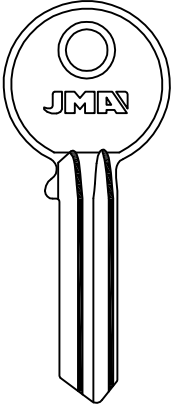
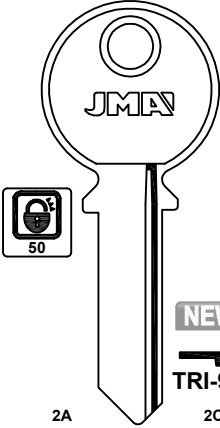
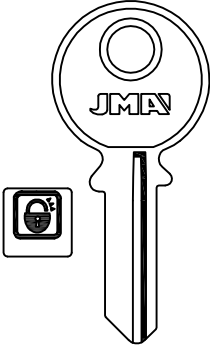
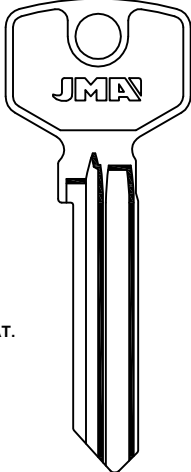
TOUCH	TOVER	TRELOCK		
 <p>NEW  TOU-1D</p> <p>FKS</p>	 <p>ALP. * LAT.</p> <p>2F35 8.85 2.45</p> <p>TOV-4 * TOV-8D</p> <p>TROMER NEW</p>	 <p>TRL-3</p> <p>NEW</p> <p>TRL-3D</p> <p>NEW</p>	 <p>TRL-5.P</p> <p>NEW</p>	
TRELOCK		TRI-CIRCLE		
 <p>TRL-6</p> <p>NEW</p> <p>TRL-6D</p> <p>NEW</p>	 <p>NEW</p> <p>TRI-9DSP</p> <p>2A TRI-9I</p> <p>2B TRI-10I</p> <p>2C TRI-9D</p> <p>2D TRI-10D</p>	 <p>TRI-17</p> <p>NEW</p> <p>TRI-17D</p>		
TRIO-VING				
 <p>* LAT.</p>	<p>* TV-17</p> <p>* TV-20</p> <p>* TV-21</p> <p>* TV-22</p> <p>* TV-23</p>	<p>* TV-17D</p> <p>* TV-18D</p> <p>* TV-19D</p> <p>* TV-22D</p> <p>* TV-23D</p>	<p>* TV-39</p> <p>NEW</p> <p>TV-36</p> <p>NEW</p> <p>TV-35</p> <p>NEW</p> <p>TV-34</p> <p>NEW</p> <p>TV-32</p> <p>TV-31</p> <p>* TV-30</p>	<p>* TV-40D</p> <p>NEW</p> <p>TV-41</p> <p>NEW</p>



TRIO-VING

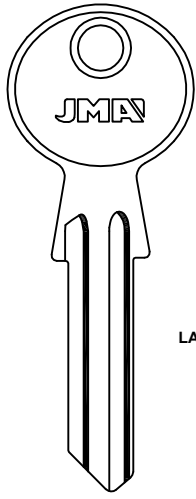

LAT.



TV-37

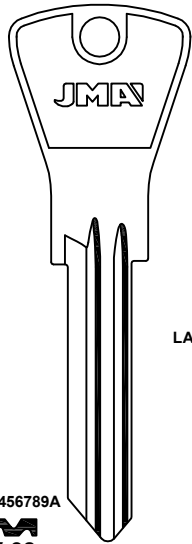

LAT.

.....123456789A



TV-38

JOLI SAFE

UCEM

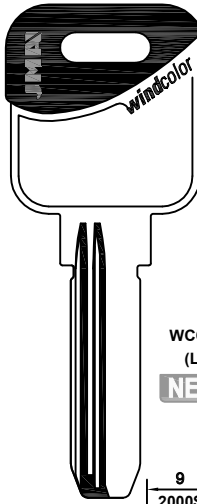

WCOLOR (LAT.)

NEW

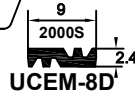

UCEM-8D

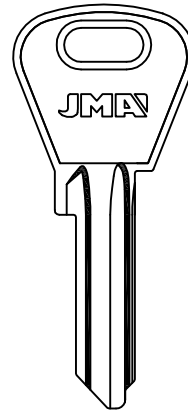

UCEM-19

TITAN

PARA-FOR:
TRIO-VING (N)
UCEM (E)
UNIVERSAL

UCEM

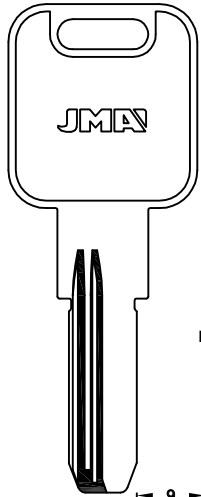

LAT.

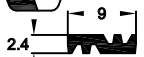

UCEM-20D

NEW

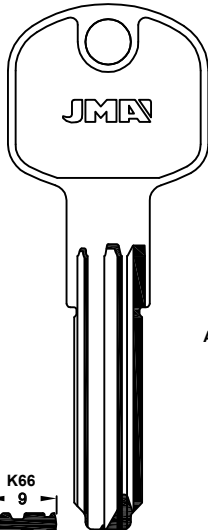

ALP.

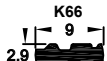

UCEM-21

NEW

REMOCON

UNIVERSAL

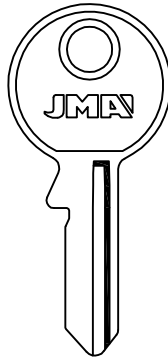

TX-12

FLOK

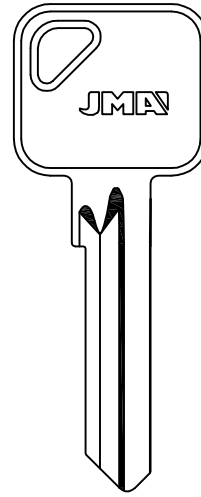

TX-13D

EURO SPEC

UNIVERSAL

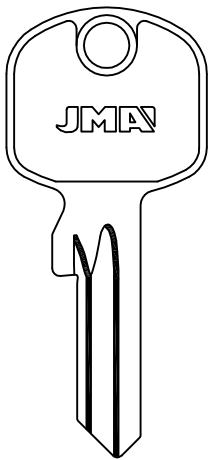

U-4GD

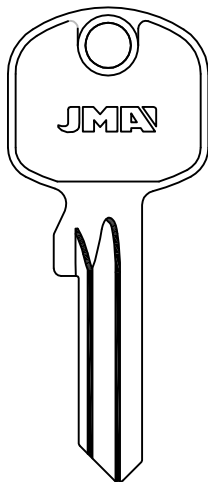

U-5GD

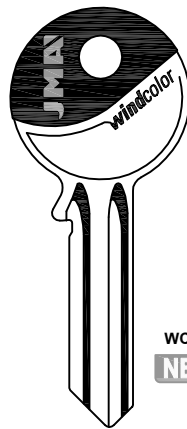

WCOLOR

NEW



U-5I



U-5D

ESAFE-SIL

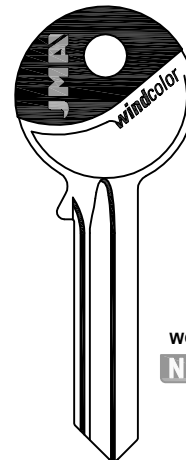

WCOLOR

NEW











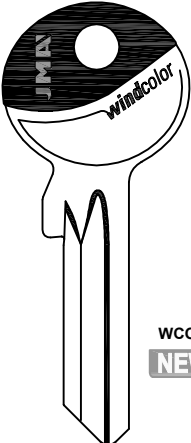

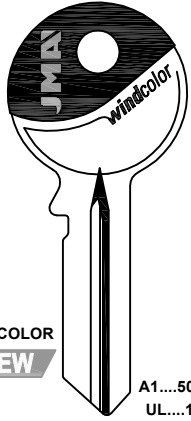

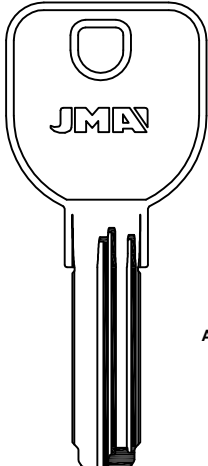

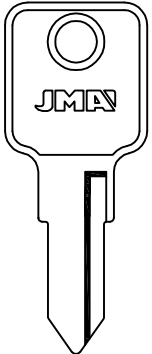

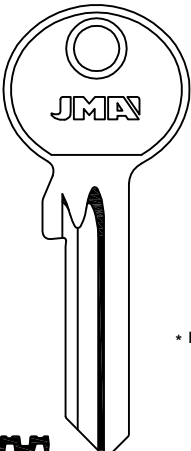
U-6D

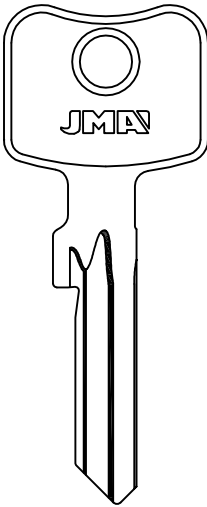
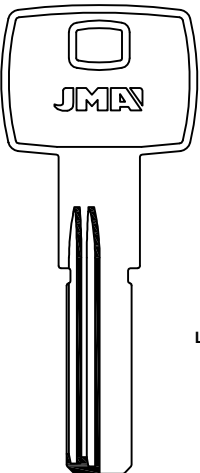

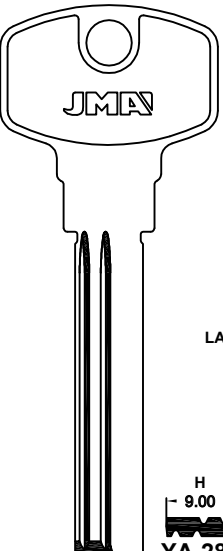
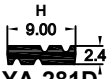
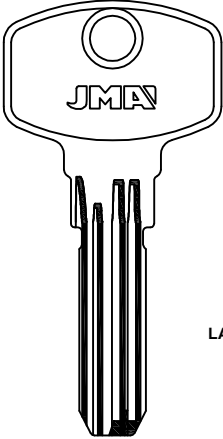
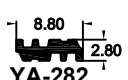
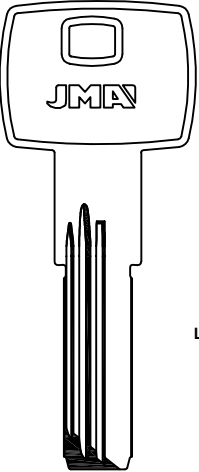

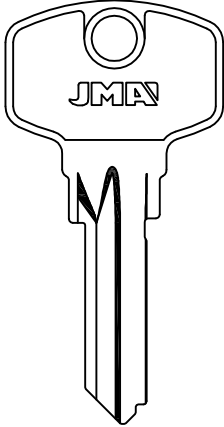

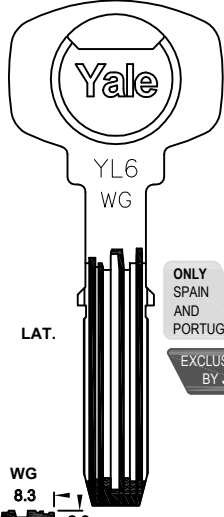
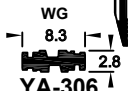
PARA-FOR:

- UNIVERSAL
- VACHETTE (F)
- WILKA (D)
- YALE (D-GB-USA)

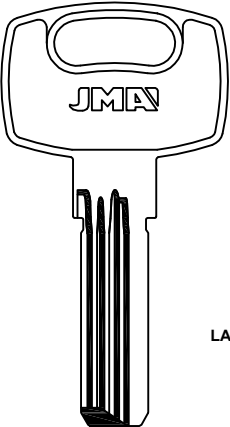
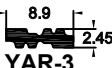
UNIVERSAL	VACHETTE		VARIOS	
 <p>WCOLOR NEW</p>  <p>U-15D</p>	 <p>WCOLOR NEW</p> <p>A1....5001-5631 UL....1-3500 U....1 AL 9 AL 0</p>  <p>VA-8D VA-75D</p>	 <p>ALP.</p>  <p>VA-91 NEW</p>	 <p>PL-1 NEW</p>  <p>PL-1D NEW</p>	
WILKA		YALE		
 <p>WIL-23 NEW</p> <p>* MTIC.</p>  <p>WIL-4D</p> <p>JORE-WIGRO</p>	 <p>WIL-66D NEW</p> <p>BIFFAR-BEFA</p>	 <p>YA-280D NEW</p> <p>LAT.</p> 	 <p>YA-281D NEW</p> <p>LAT.</p> 	
YALE				
 <p>YA-282 NEW</p> <p>LAT.</p> 	 <p>YA-283D NEW</p> <p>LAT.</p> 	 <p>YA-300D NEW</p> <p>LAT.</p> 	 <p>YA-306 NEW</p> <p>LAT.</p>  <p>ONLY SPAIN AND PORTUGAL EXCLUSIVE BY JMA</p>	

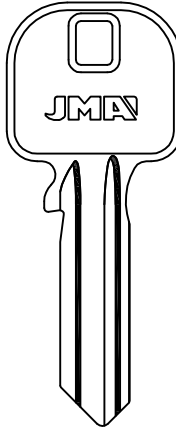
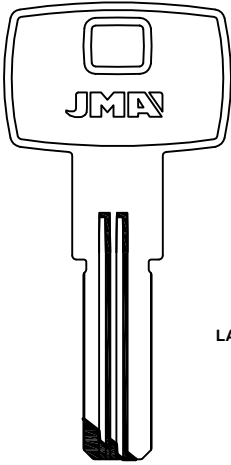

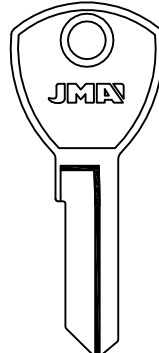
YARDENI	YETI		YUN HUAN
 <p>LAT.</p>  <p>8.9 2.45 YAR-3</p>  <p>NEW YAR-4D</p>	 <p>NEW YET-18</p>	 <p>LAT.</p>  <p>8.8 2.5 NEW YET-19D</p> <p>LOB</p>	 <p>NEW YUH-3D</p>

PARA-FOR:
 YARDENI (NL)
 YETI (RC)
 YUN HUAN (PRC)



LLAVES PARA VEHÍCULOS

IBILGAILUENTZAKO GILTZAK

KEYS FOR VEHICLES

CLÉS POUR VÉHICULES

FAHRZAUGESCHLÜSSEL











SUPLEMENTO-SUPPLEMENT

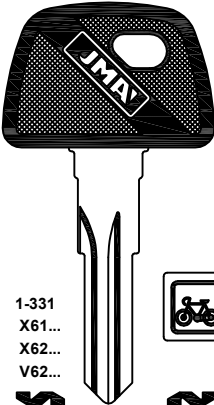

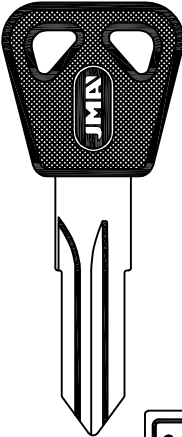
C.11 2020

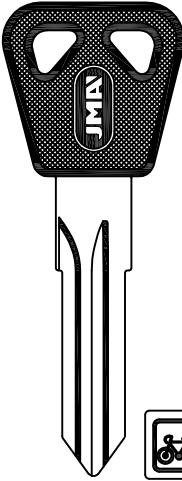

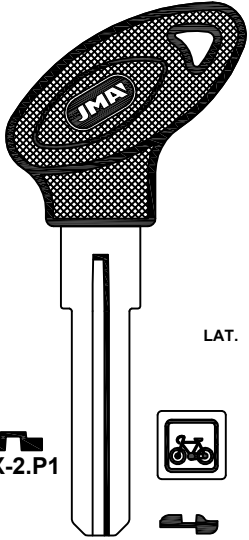

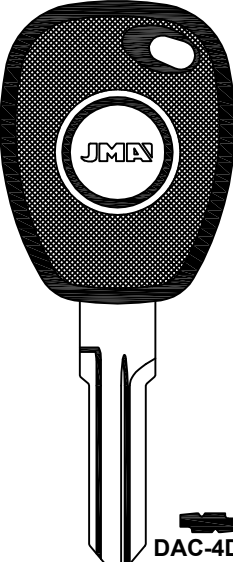

THE KEY TO EXCELLENCE
GLOBALLY UNLOCKING MILLIONS OF DOORS DAILY

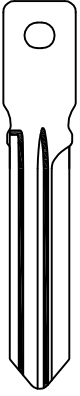
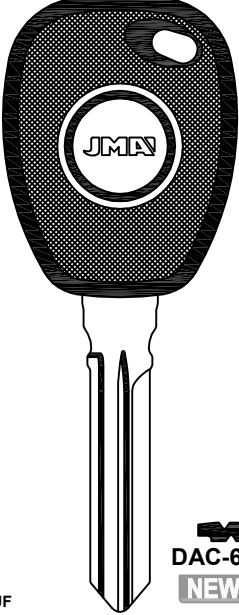
PARA-FOR:

- ABUS (D)
- AXA (S)
- DACIA (R)
- EURO LOCKS (B)
- FORD (USA)
- GAD (NL)

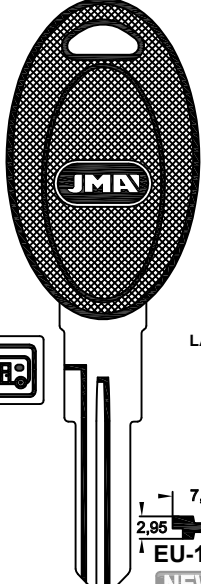
ABUS			AXA
 <p>1-331 X61... X62... V62...</p> <p>ABU-35.P</p>  <p>ABU-35D.P NEW</p> <p>1-331 V61... V62...</p> <p>ABU-36.P</p> <p>BUFFO</p>	 <p>NW52</p> <p>ABU-87.P NEW</p> 	 <p>NW72</p> <p>ABU-88.P NEW</p> 	 <p>LAT.</p> <p>AX-2.P1</p>  <p>AX-5D.P1 NEW</p> <p>BUFFO</p>

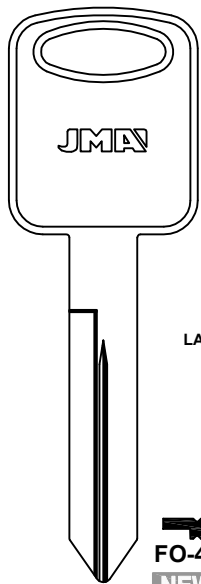
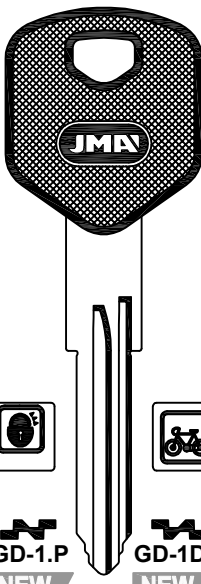
DACIA			
 <p>DAC-4D.P NEW</p> <p>HUF</p>	 <p>DAC-7DC1 NEW</p> <p>HUF</p>	 <p>DAC-6DC1 NEW</p> <p>HUF</p>	 <p>DAC-6D.P NEW</p> <p>HUF</p>

EUROLOCKS		FORD	GAD
 <p>LAT.</p>  <p>7,6 2,9</p> <p>EU-15.P NEW</p> <p>HOBBY-HYMER</p>	 <p>LAT.</p>  <p>7,2 2,95</p> <p>EU-16DP NEW</p> <p>HOBBY</p>	 <p>LAT.</p> <p>FO-43D NEW</p>	 <p>LAT.</p>  <p>GD-1.P NEW</p>  <p>GD-1D.P NEW</p>



HUF

PARA-FOR:

HUF (D)

HYUNDAI (K)

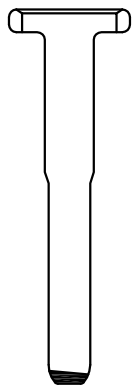

ALP.

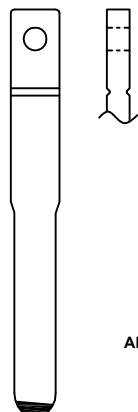

ALP.

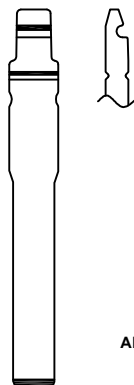
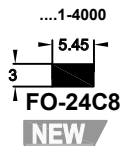

ALP.

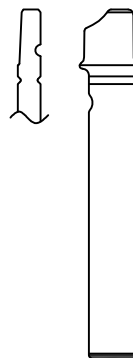
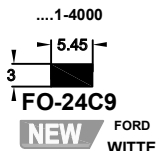

ALP.



HUF

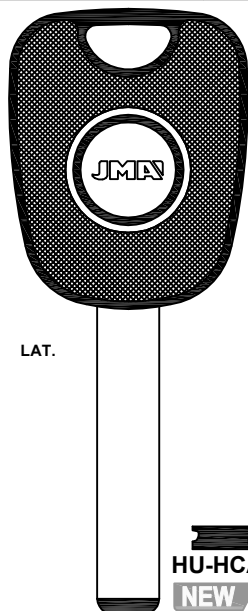

LAT.

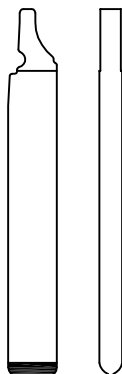

ALP.

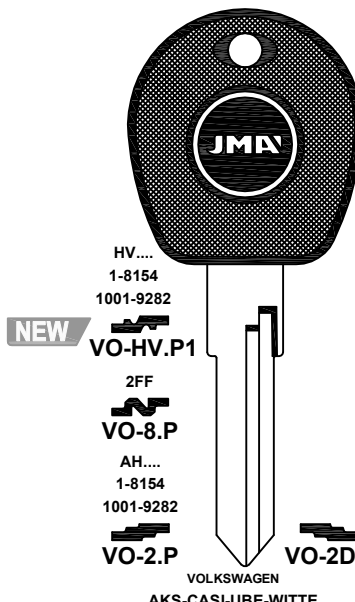
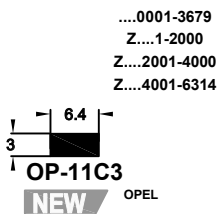

NEW



HUF

HYUNDAI

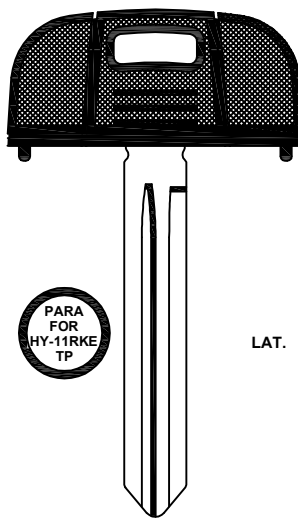
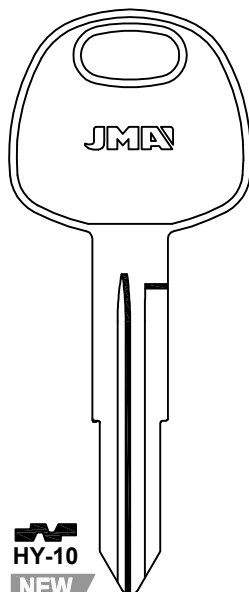
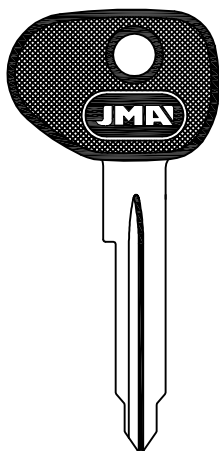

PARA FOR HY-11RKE TP

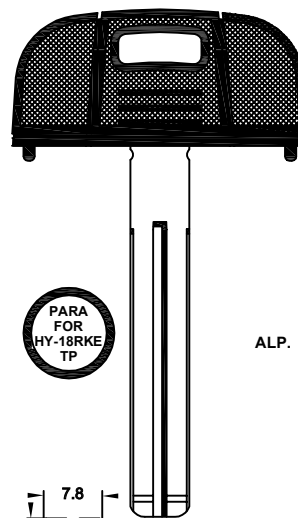

LAT.





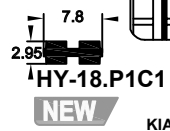





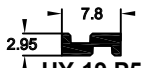

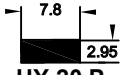
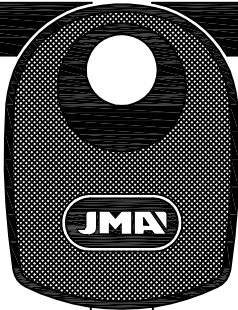



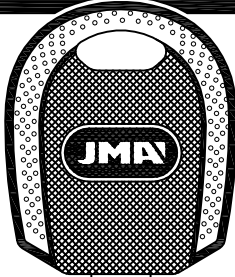



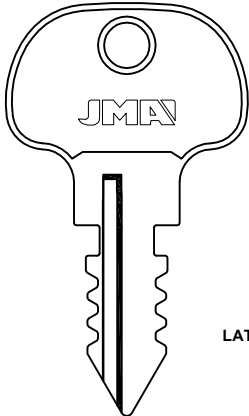

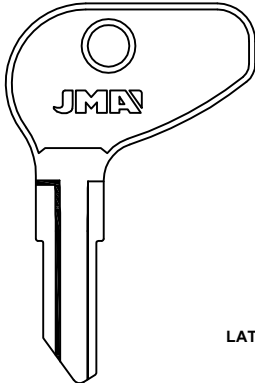

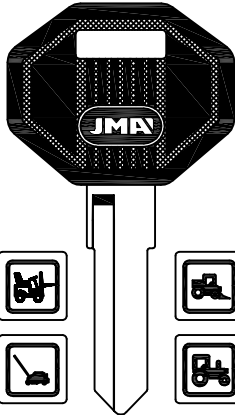
PARA FOR HY-18RKE TP

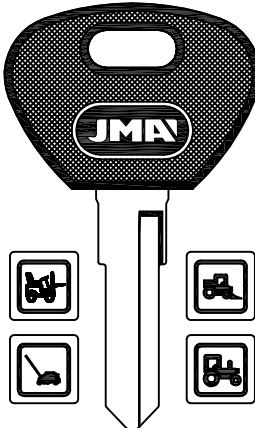
ALP.

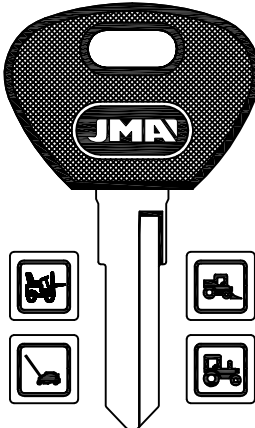

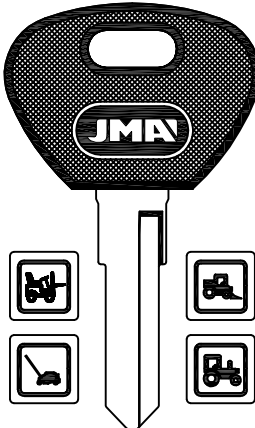
PARA-FOR:

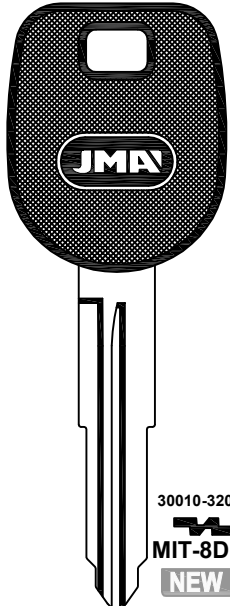
- HYUNDAI (K)
- ISUZU (J)
- KIA (K)
- KTM (A)
- KUBOTA (J)
- MERIT-LINDE (D)
- mitsubishi (J)



HYUNDAI			
 LAT.  HY-19.P5 NEW		 LAT.  HY-20.P NEW	
		 ISUZU  ISU-3D.P1 NEW	
KIA		KTM	
 LAT.  KI-11.P NEW		 LAT.  KI-12.P NEW	
		 LAT. ... 00001-03001  KM-1P NEW	
KUBOTA			
 LAT.  KUB-1D NEW			
KUBOTA		MERIT-LINDE	
 LAT.  KUB-2D NEW KUBOTA-MAHINDRA-MITSUBISHI		 LAT.  MERI-1D.P NEW	
		 LAT.  MERI-2D.P NEW	
		 LAT.  MERI-1.P1 NEW	
		 LAT.  MERI-1D.P1 NEW	
MITSUBISHI			
 LAT. 30010-32009  MIT-8D.P2 NEW			

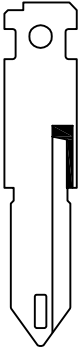
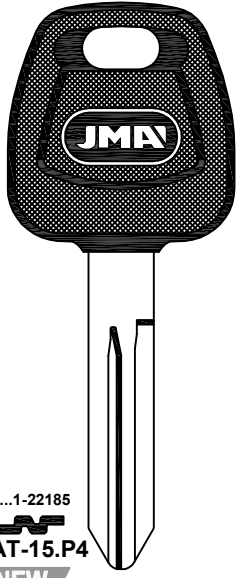
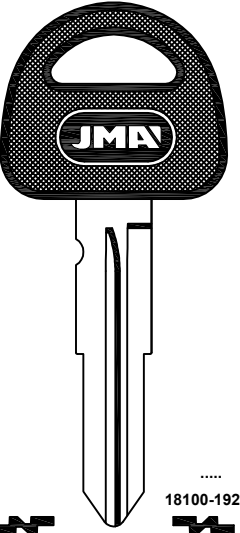

NEIMAN	NISSAN	SUZUKI
 <p>..1/9.... 1/9....A/Z .1/9....A/Z ..1/9....A/Z ...1/9...A/Z1/9..A/Z1/9..A/Z A/Z1/9..A/Z M-N-P-R-S</p> <p>NE-60C3 NEW</p>	 <p>....1-22185</p> <p>DAT-15.P4 NEW</p>	 <p>..... 18100-19229</p> <p>SUZU-8I.P SUZUKI SUZU-8.P NEW</p>

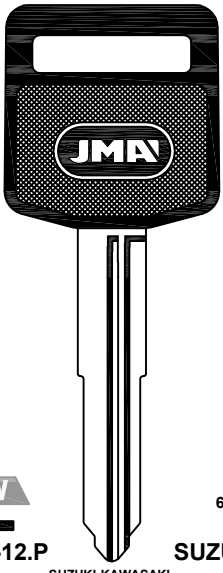
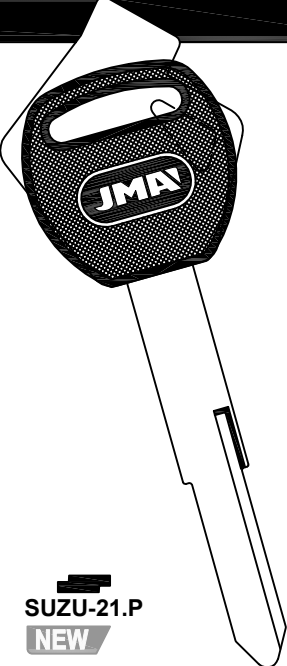
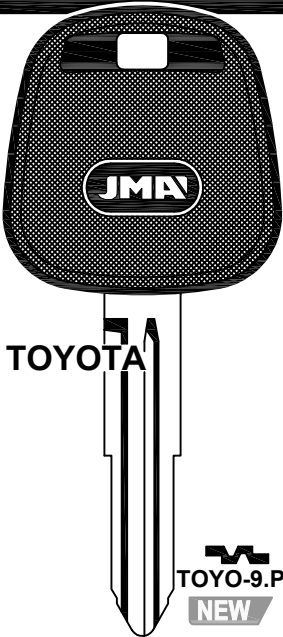
PARA-FOR:
 NEIMAN (F)
 NISSAN (J)
 SUZUKI (J)
 TOYOTA (J)

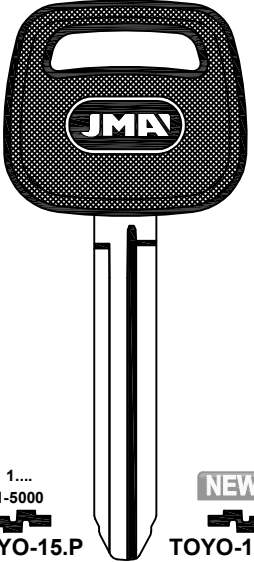





SUZUKI		
 <p>NEW</p> <p>SUZU-12.P SUZUKI-KAWASAKI</p>	 <p>..... 6001-7000</p> <p>SUZU-12D.P NEW</p>	 <p>TOYOTA</p> <p>TOYO-9.P2 NEW</p>

TOYOTA		TOYOTA
 <p>1.... 1-5000</p> <p>TOYO-15.P GM-TOYOTA-DAEWOO TOKAJ-RIKA</p>	 <p>NEW</p> <p>1.... 1-5000</p> <p>TOYO-15.P10 NEW</p>	 <p>LAT.</p> <p>NEW</p> <p>TOYO-41.P 7,8 2,95</p> <p>TOYO-18.P LEXUS-MAZDA-TOYOTA TOKAJ-RIKA</p>

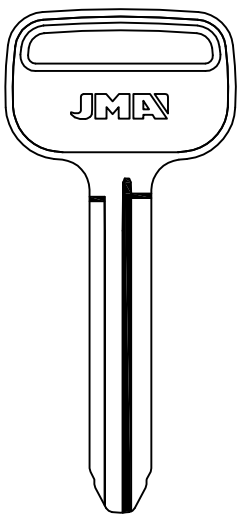
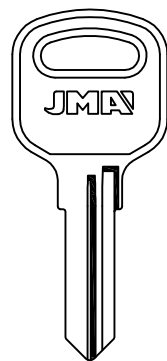

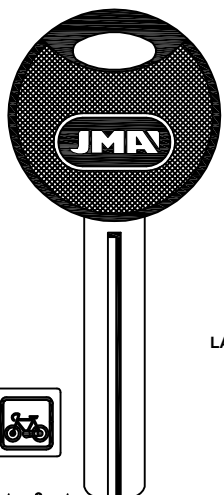
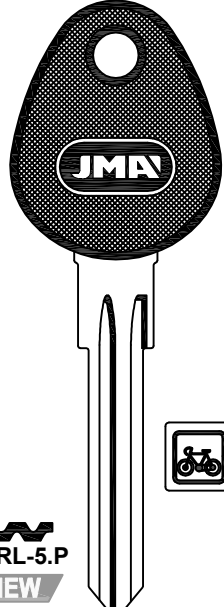
PARA-FOR:

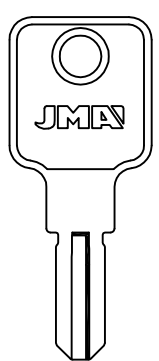
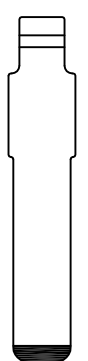
- TOYOTA (J)
- TRELOCK (D)
- TRIUMPH MOT. (USA)
- TRW-SIPEA (I)
- VACHETTE (F)
- VALEO (D)
- YAMAHA (J)

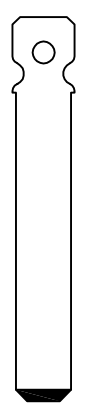
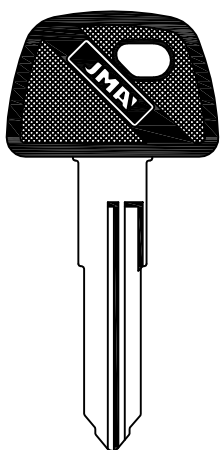
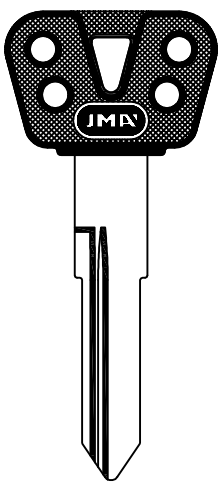
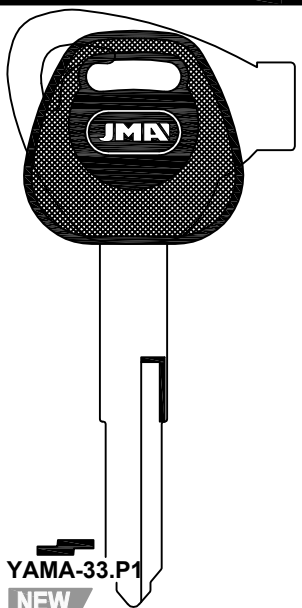
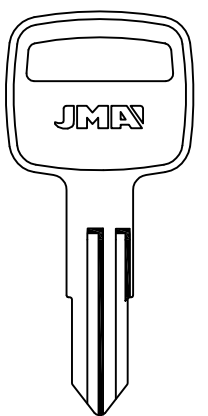
TOYOTA		TRELOCK			
 <p>TOYO-40 NEW</p> <p>TOYO-40D NEW</p>		 <p>TRL-3 NEW</p>		 <p>TRL-4.P NEW</p> <p>2.95</p> <p>8</p>	 <p>TRL-5.P NEW</p> <p>LAT.</p> 
TRIUMPH MOT.		TRW-SIPEA	VACHETTE	VALEO	
 <p>LAT.</p> <p>6.5</p> <p>2.2</p> <p>TRP-2 NEW</p>	 <p>ALP.</p> <p>7.6</p> <p>3</p> <p>FI-16C3 NEW</p>	 <p>.....A/Z 0/9 1-4092A/Z 0/9 5001-9092A/Z 0/9 1-4092A/Z 0/9 5001-9092</p> <p>VA-61C3 NEW</p>	 <p>ALP.</p> <p>.....1-2-3-4-Q-5-6-7-8-HA-B-C-D-E-F</p> <p>7</p> <p>3</p> <p>CIT-1C1 NEW</p> <p>CITROEN</p>		
YAMAHA					
 <p>NEW</p> <p>6001-7000</p> <p>YAMA-25.P YAMA-25D.P PUCH-VESPA-YAMAHA</p>	 <p>YAMA-32D.P NEW</p>	 <p>YAMA-33.P1 NEW</p>	 <p>YAMA-34 NEW</p> <p>YAMA-34D NEW</p>		



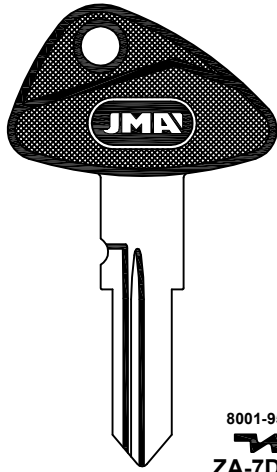

8001-9554

ZA-7D.P1 **NEW**
8001-9554

ZA-6D.P
BMW

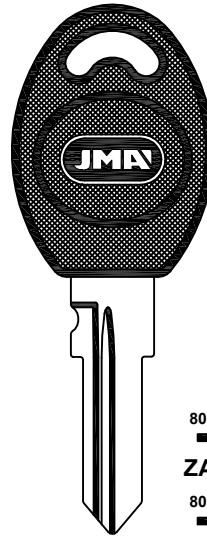

8001-9554

ZA-9.P2 **NEW**
8001-9554

ZA-6D.P1
APRILIA-BETA



LLAVES DE CRUZ-GORJA-ARMARIO

GURUTZE-GORJA-ARMAIRUETARAKO GILTZA

CRUCIFORM- BIT -FURNITURE KEYS

CLÉS CRUCIFORMES-GORGES- POUR MEUBLES

KREUTZSCHLÜSSEL-CHUBBSCHLÜSSEL-MOBELSCHÜSSEL

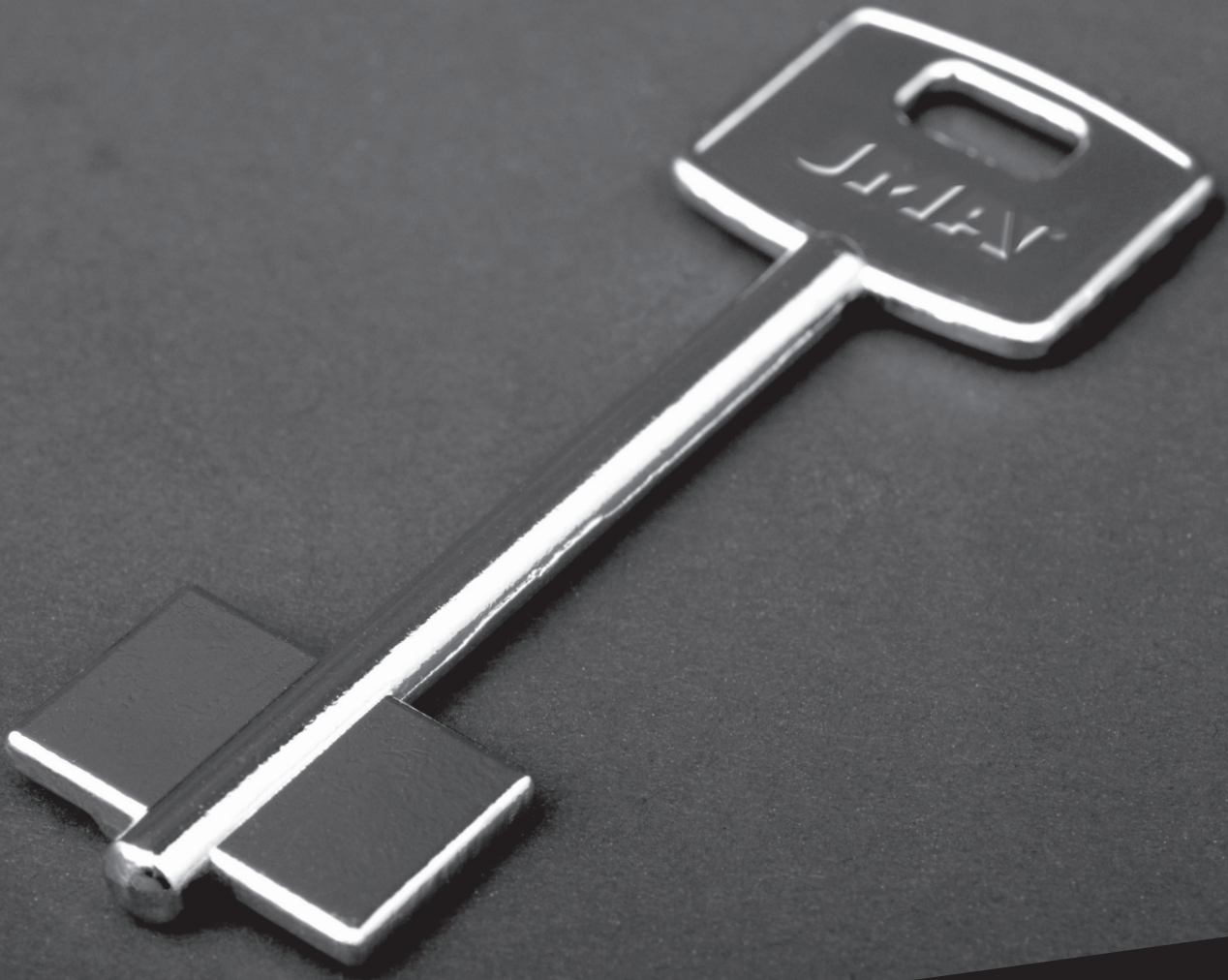

SUPLEMENTO-SUPPLEMENT

C.11 2020

THE KEY TO EXCELLENCE
GLOBALLY UNLOCKING MILLIONS OF DOORS DAILY

PARA-FOR:

101 (P)

716 (P)

BRICARD (F)

CLASS (RUS)

101

716

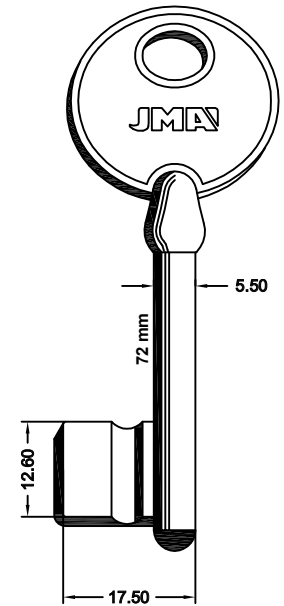
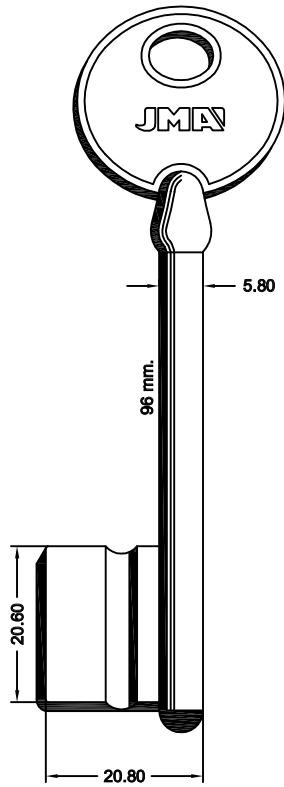

BRICARD

CLASS

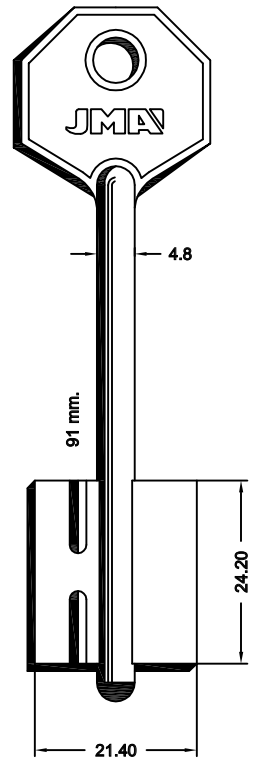
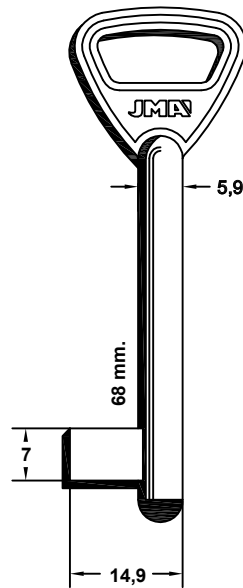
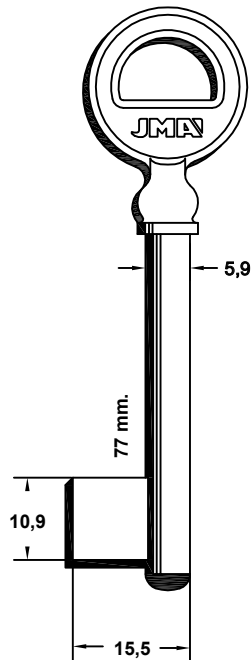
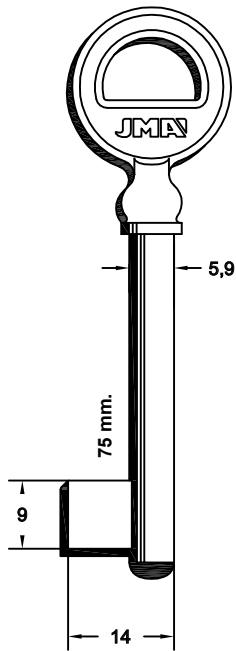

CLASS

DEBEAURAIN-ND

PARA-FOR:

CLASS (RUS)
 DEBEAURAIN
 ND (F)
 DENY (F)
 ELBOR (RUS)
 EUROSPEC
 (GB)

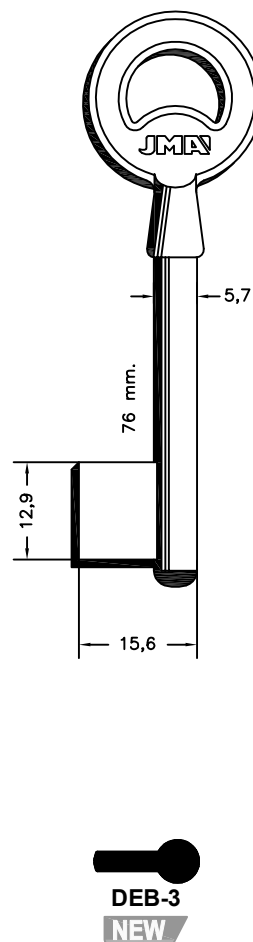
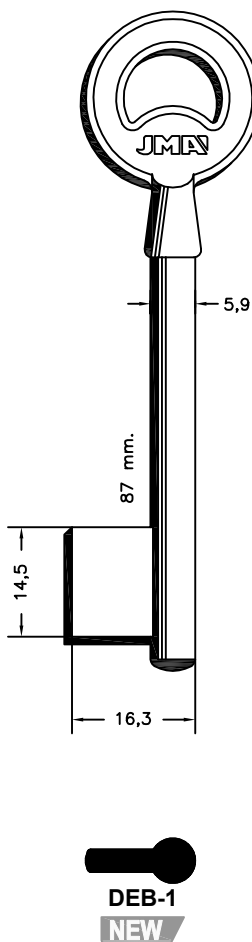
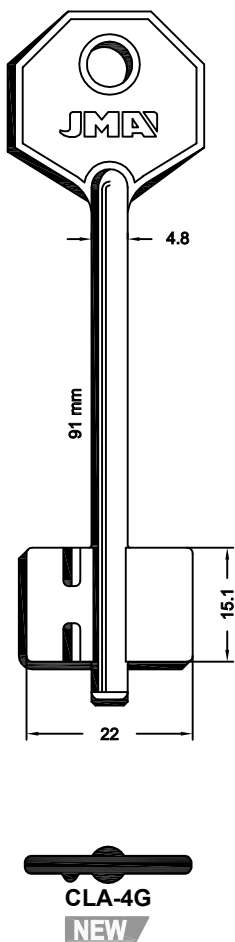
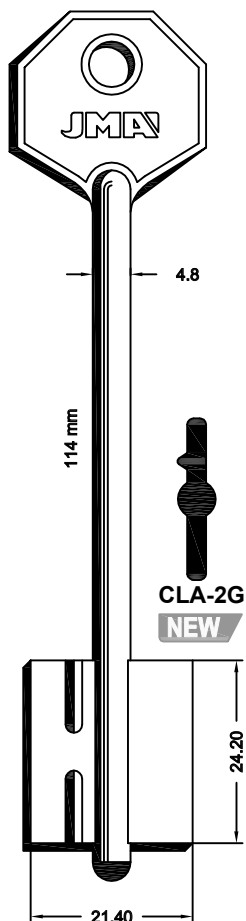

DENY

ELBOR

EUROSPEC

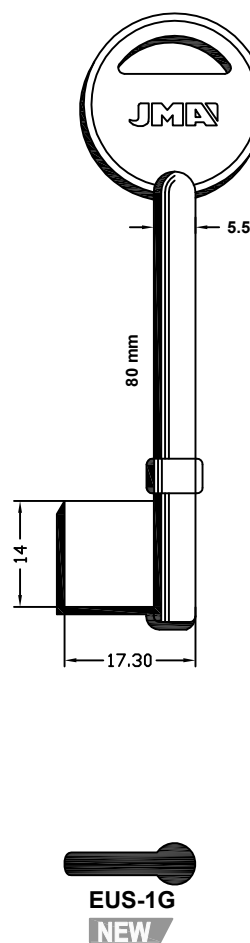
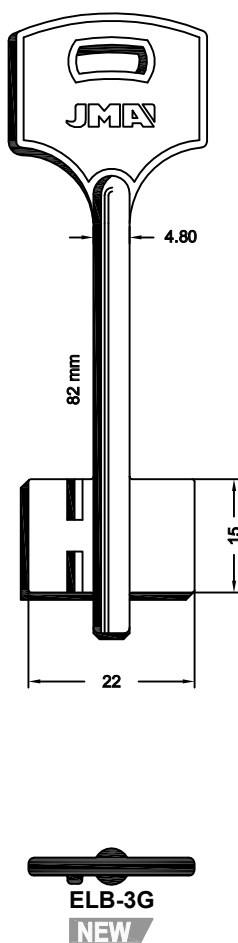
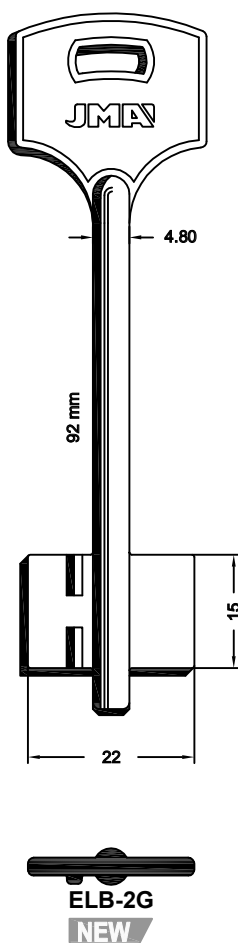
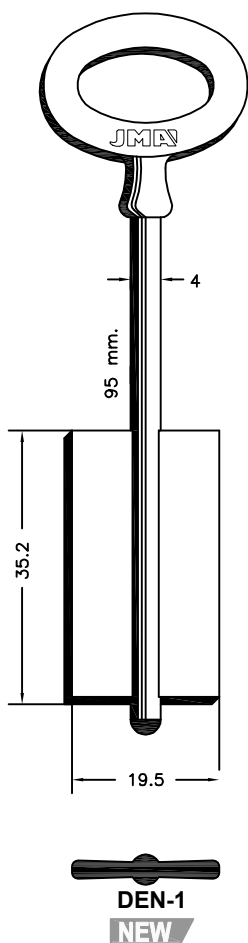

PARA-FOR:
 EZCURRA (E)
 FAS (S)
 FICHET (F)
 GARDIAN (RUS)
 GERION (RUS)

EZCURRA		FAS	
	<p>C EZ-3G</p> <p>D EZ-4G</p> <p>E EZ-5G</p> <p>F EZ-6G</p> <p>H EZ-11G NEW</p>		
<p>A EZ-1G</p> <p>B EZ-2G</p>		<p>FA-9G NEW</p> <p>FA-10G NEW</p>	

FAS	FICHET	GARDIAN	GERION
<p>FA-11G NEW</p>	<p>FIC-400 NEW</p>	<p>GARD-2G NEW</p>	<p>GER-2G NEW</p>



GERION

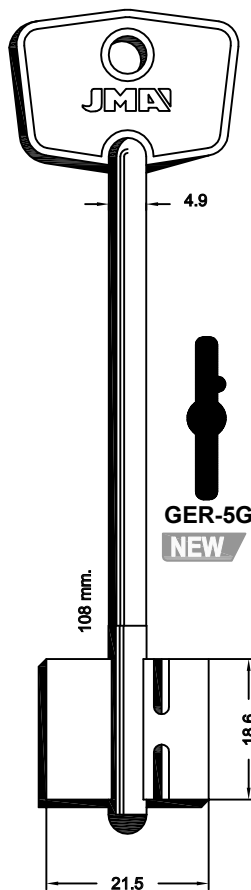
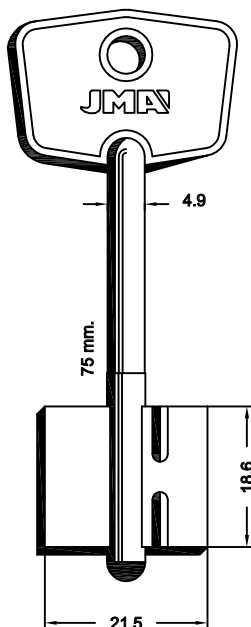
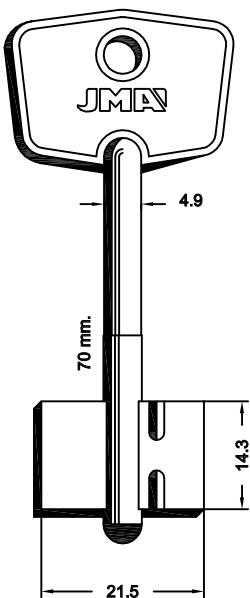

HOBES

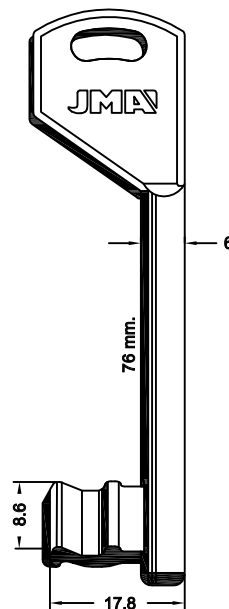

PARA-FOR:
GERION (RUS)
HOBES (PL)
JPM (F)

JPM

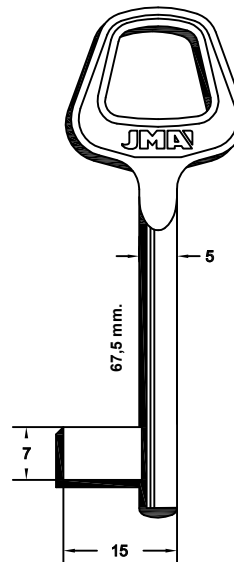
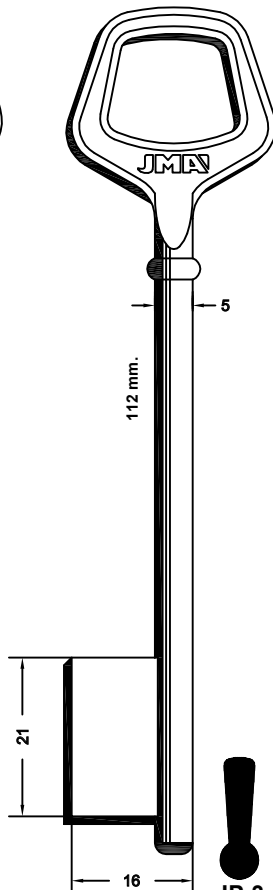
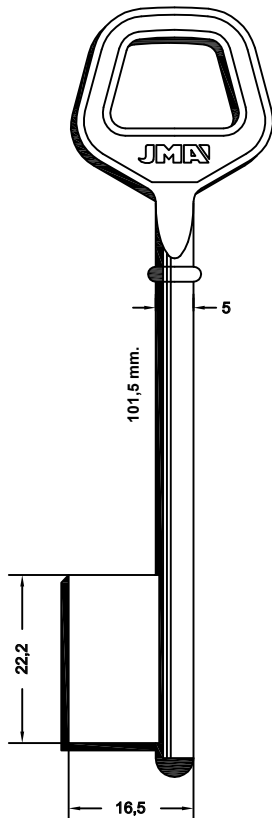
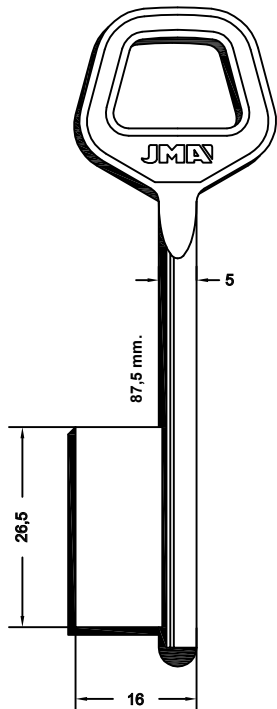

PARA-FOR:

- JPM (F)
- LAPERCHE (F)
- MAFOR (F)
- MOIA (I)
- MOTTURA (I)

JPM		LAPERCHE	
 JP-5 NEW	 JP-6 NEW	 LAP-3 NEW	 LAP-100 NEW

MAFOR	MOIA		MOTTURA
 MAF-1 NEW	 MOI-4G O.M.R.	 MOI-5G O.M.R.	 MT-17P1G NEW



POTENT

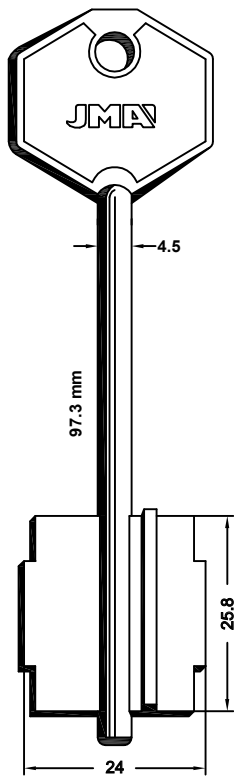

SELECT

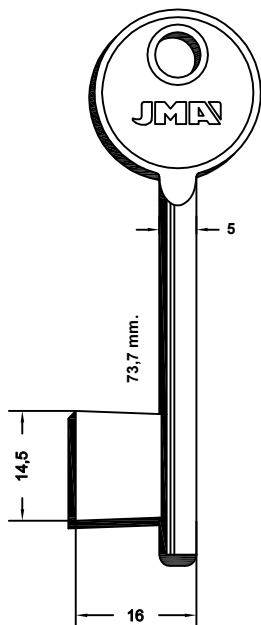

VACHETTE

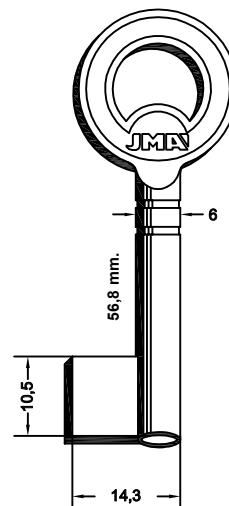
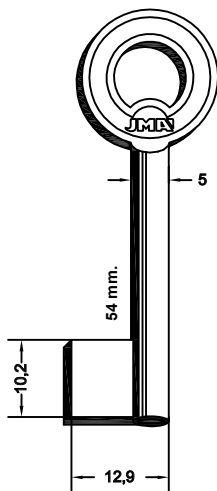

PARA-FOR:

- POTENT (I)
- SELECT (F)
- VACHETTE (F)

VACHETTE

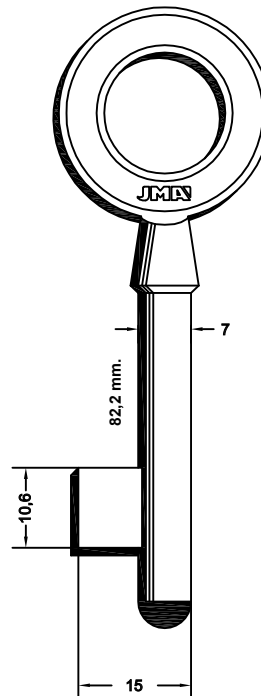
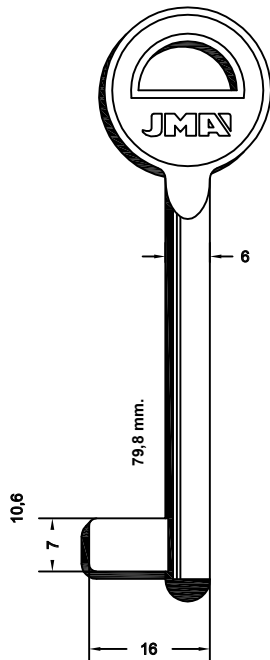
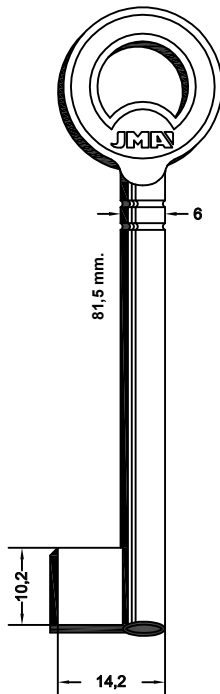
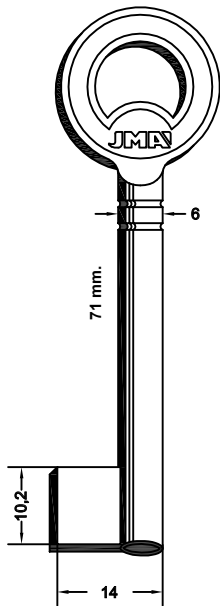

ESPECIALISTA
SPECIALIST

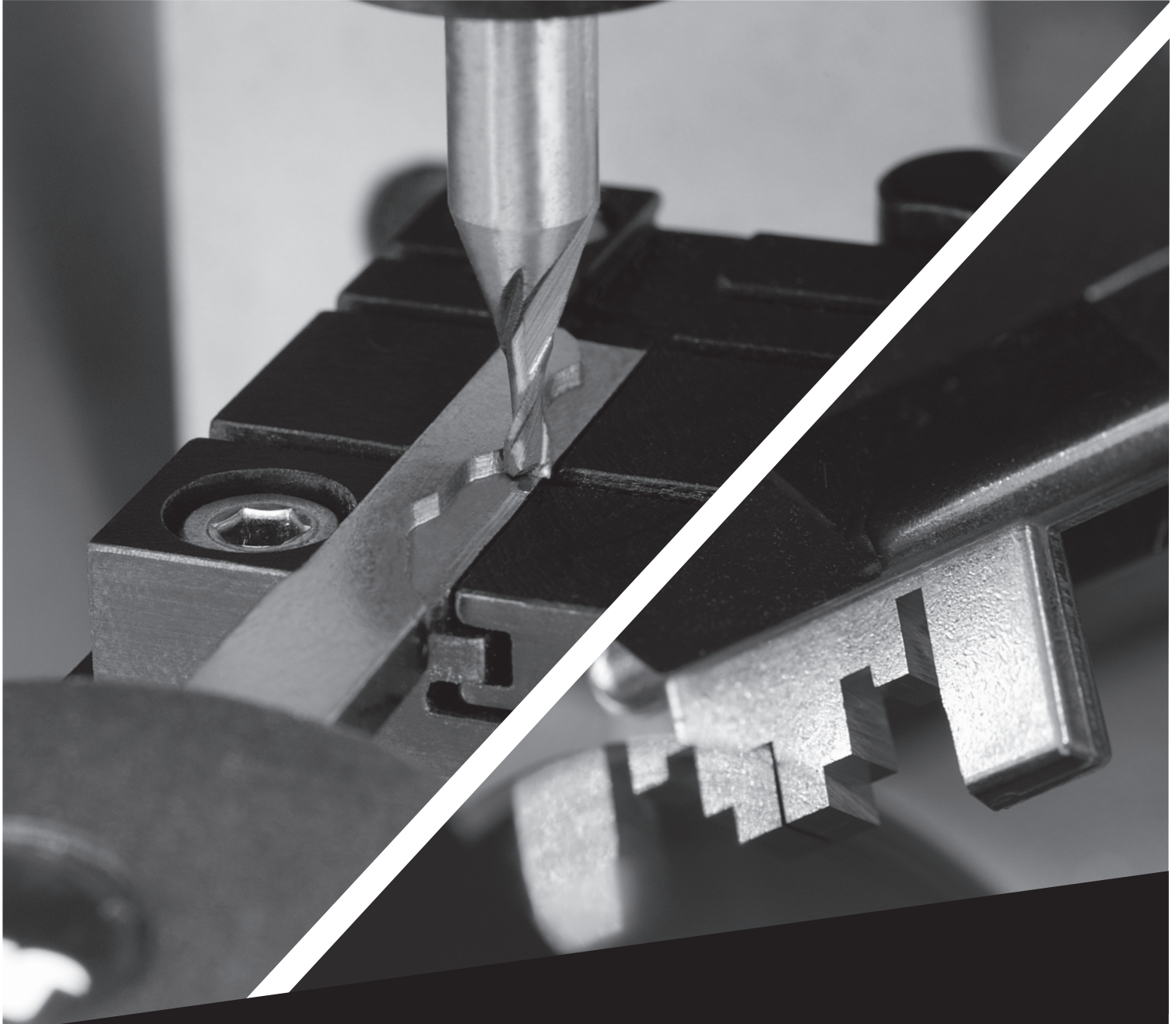

SUPLEMENTO-SUPPLEMENT
C.11 2020

THE KEY TO EXCELLENCE
GLOBALLY UNLOCKING MILLIONS OF DOORS DAILY

MAQUINAS - MACHINES



CAPRI



CAPRISMART



NEO



MULTICODE



X-CODE

FRESAS - CUTTERS

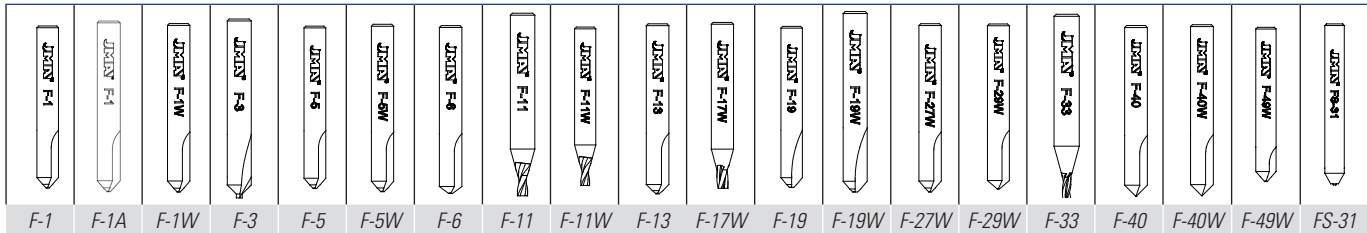

FRESAS - CUTTERS

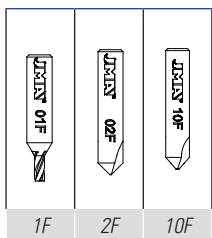



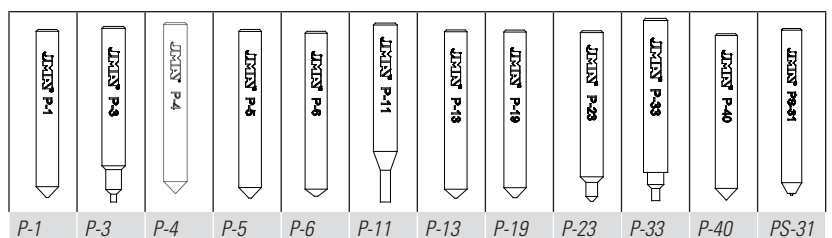



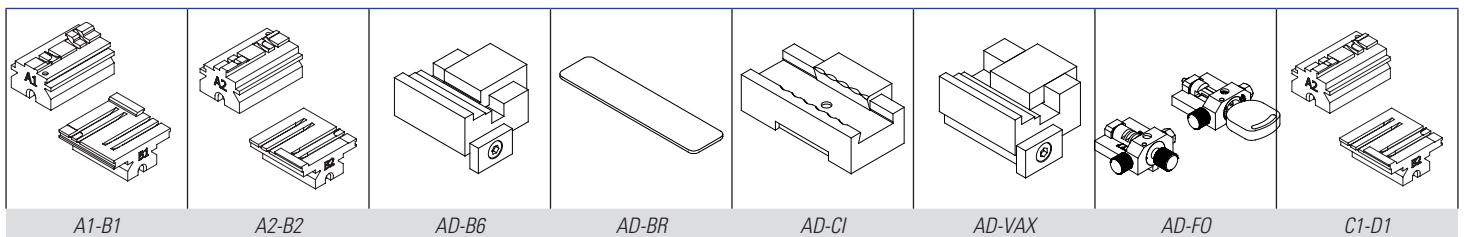





PALPADORES-TRACERS













ADAPTADORES - ADAPTORS











						
ABUS	ABU-91	CAPRI	F-1	P-1	AD-CI	
		CAPRI S.	F-1	P-1	AD-CI	
		NEO-DAKKI	F-1	P-1	AD-CI	
	ABU-96	CAPRI	F-1	P-1	AD-CI	
		CAPRI S.	F-1	P-1	AD-CI	
		NEO-DAKKI	F-1	P-1	AD-CI	
	ORIGINAL BRAVUS	CAPRI	F-40	P-40	AD-BR	
		CAPRI S.	F-40	P-40	AD-BR	
		NEO-DAKKI	F-40	P-40	AD-BR	
XCODE		F-40W		AD-BR		
AGA	AGA-55D	CAPRI	F-1	P-1		
		CAPRI S.	F-1	P-1		
		NEO-DAKKI	F-1	P-1		
AMIG	AMG-11	CAPRI	F-5	P-5		
		CAPRI S.	F-5	P-5		
		NEO-DAKKI	F-5	P-5		
AXA	AX-5DP1	CAPRI	F-33	P-33		
		CAPRI S.	F-33	P-33		
		NEO-DAKKI	F-33	P-33		
		XCODE	F-33			
	AX-6	CAPRI	F-1	P-23		
		CAPRI S.	F-1	P-23		
	NEO-DAKKI	F-1	P-23			
BRISANT	BRN-1D	CAPRI	F-1	P-1		
		CAPRI S.	F-1	P-1		
		NEO-DAKKI	F-1	P-1		
BURG	BUR-41	NEO-DAKKI	F-1	P-1		
		CAPRI S.	F-1	P-1		
		CAPRI	F-1	P-1		
	BUR-43	CAPRI	F-1	P-1		
		CAPRI S.	F-1	P-1		
		NEO	F-1	P-1		
BRISANT	BRN-2D	NEO-DAKKI	F-19	P-19		
		CAPRI	F-19	P-19		
		CAPRI S.	F-19	P-19		
		XCODE	F-19W			
		MULTICODE	2F		A1-B1	
CISA	CI-48	CAPRI	F-1	P-1	AD-CI	
		CAPRI S.	F-1	P-1	AD-CI	
		NEO-DAKKI	F-1	P-1	AD-CI	
	CI-48P	CAPRI	F-1	P-1	AD-CI	







						
			CAPRI S.	F-1	P-1	AD-CI
			NEO-DAKKI	F-1	P-1	AD-CI
CI-71			CAPRI	F-1	P-1	AD-CI
			CAPRI S.	F-1	P-1	AD-CI
			NEO-DAKKI	F-1	P-1	AD-CI
CI-71P			CAPRI	F-1	P-1	AD-CI
			CAPRI S.	F-1	P-1	AD-CI
			NEO-DAKKI	F-1	P-1	AD-CI
CI-72			CAPRI	F-1	P-1	AD-CI
			CAPRI S.	F-1	P-1	AD-CI
			NEO-DAKKI	F-1	P-1	AD-CI
CI-72P			CAPRI	F-1	P-1	AD-CI
			CAPRI S.	F-1	P-1	AD-CI
			NEO-DAKKI	F-1	P-1	AD-CI
CI-73			CAPRI	F-1	P-1	AD-CI
			CAPRI S.	F-1	P-1	AD-CI
			NEO-DAKKI	F-1	P-1	AD-CI
CI-73P			CAPRI	F-1	P-1	AD-CI
			CAPRI S.	F-1	P-1	AD-CI
			NEO-DAKKI	F-1	P-1	AD-CI
CI-75P			CAPRI	F-1	P-1	AD-CI
			CAPRI S.	F-1	P-1	AD-CI
			NEO-DAKKI	F-1	P-1	AD-CI
CI-76P			CAPRI	F-1	P-1	AD-CI
			CAPRI S.	F-1	P-1	AD-CI
			NEO-DAKKI	F-1	P-1	AD-CI
CI-77P			CAPRI	F-1	P-1	AD-CI
			CAPRI S.	F-1	P-1	AD-CI
			NEO-DAKKI	F-1	P-1	AD-CI
CI-78P			CAPRI	F-1	P-1	AD-CI
			CAPRI S.	F-1	P-1	AD-CI
			NEO-DAKKI	F-1	P-1	AD-CI
CI-79P			CAPRI	F-1	P-1	AD-CI
			CAPRI S.	F-1	P-1	AD-CI
			NEO-DAKKI	F-1	P-1	AD-CI
CI-80P			CAPRI	F-1	P-1	AD-CI
			CAPRI S.	F-1	P-1	AD-CI
			NEO-DAKKI	F-1	P-1	AD-CI
CI-81			CAPRI	F-1	P-1	AD-CI
			CAPRI S.	F-1	P-1	AD-CI
			NEO-DAKKI	F-1	P-1	AD-CI
CI-81P			CAPRI	F-1	P-1	AD-CI







						
		CAPRI S.	F-1	P-1	AD-CI	
		NEO-DAKKI	F-1	P-1	AD-CI	
	CI-82P	CAPRI	F-1	P-1	AD-CI	
		CAPRI S.	F-1	P-1	AD-CI	
		NEO-DAKKI	F-1	P-1	AD-CI	
	CI-83P	CAPRI	F-1	P-1	AD-CI	
		CAPRI S.	F-1	P-1	AD-CI	
		NEO-DAKKI	F-1	P-1	AD-CI	
		XCODE	F-1W		AD-X03	
		MULTICODE	2F		C1-D1	
	CI-84P	CAPRI	F-1	P-1	AD-CI	
		CAPRI S.	F-1	P-1	AD-CI	
		NEO-DAKKI	F-1	P-1	AD-CI	
		XCODE	F-1W		AD-X03	
		MULTICODE	2F		C1-D1	
	DELTA	DLT-1D	CAPRI S.	F-5	P-5	
CAPRI S.			F-5	P-5		
NEO			F-5	P-5		
DEKABA	DEK-16	CAPRI	F-1	P-1		
		CAPRI S.	F-1	P-1		
		NEO-DAKKI	F-1	P-1		
	DEK-17	CAPRI	F-6	P-6		
		CAPRI S.	F-6	P-6		
		NEO-DAKKI	F-6	P-6		
DIERRE	DR-2D	CAPRI	F-13	P-13		
		CAPRI S.	F-13	P-13		
		NEO-DAKKI	F-13	P-13		
DOM	DOM-B1	CAPRI	F-1	P-1		
		CAPRI S.	F-1	P-1		
		NEO-DAKKI	F-1	P-1		
	DOM-B2	CAPRI	F-1	P-1		
		CAPRI S.	F-1	P-1		
		NEO-DAKKI	F-1	P-1		
	DOM-B6	CAPRI	F-1A	P-23	AD-B6	
		CAPRI S.	F-1A	P-23	AD-B6	
		NEO-DAKKI	F-1A	P-23	AD-B6	
ELZETT	ELZ-13	CAPRI	F-5	P-5		
		NEO-DAKKI	F-5	P-5		
		CAPRI S.	F-5	P-5		
EUROLOCKS	EU-15P	CAPRI	F-33	P-33		
		NEO-DAKKI	F-33	P-33		
		CAPRI S.	F-33	P-33		







						
	EU-16DP	CAPRI	F-33	P-33		
		CAPRI S.	F-33	P-33		
		NEO-DAKKI	F-33	P-33		
FERONERIA	FER-2D	CAPRI	F-19	P-19		
		CAPRI S.	F-19	P-19		
		NEO-DAKKI	F-19	P-19		
F-CV	FV-3	CAPRI	F-5	P-5		
		CAPRI S.	F-5	P-5		
		NEO-DAKKI	F-5	P-5		
FTH	FTH-30	CAPRI	F-5	P-5		
		CAPRI S.	F-5	P-5		
		NEO	F-5	P-5		
IFAM	IF-9	CAPRI	F-19	P-19		
		CAPRI S.	F-19	P-19		
		NEO	F-19	P-19		
	IF-10D	CAPRI	F-19	P-19		
		CAPRI S.	F-19	P-19		
		NEO	F-19	P-19		
GEVY	GEV-3D	CAPRI	F-1	P-1		
		CAPRI S.	F-1	P-1		
		NEO	F-1	P-1		
HOK	HOK-1D	CAPRI	F-5	P-5		
		CAPRI S.	F-5	P-5		
		NEO-DAKKI	F-5	P-5		
HUF	HU-4C1	CAPRI	F-11	P-11		
		CAPRI S.	F-11	P-11		
		NEO-DAKKI	F-11	P-11		
	FO-24C3	CAPRI	F-11	P-11		
		CAPRI S.	F-11	P-11		
		NEO-DAKKI	F-11	P-11	AD-F024	
		XCODE	F-11W			
		MULTICODE	1F		A1-B1	
	FO-24C8	CAPRI	F-11	P-11		
		CAPRI S.	F-11	P-11		
		NEO-DAKKI	F-11	P-11	AD-F024	
		XCODE	F-11W			
FO-24C9	CAPRI	F-11	P-11			
	CAPRI S.	F-11	P-11			
	NEO-DAKKI	F-11	P-11	AD-F024		
	XCODE	F-11W				
	MULTICODE	1F		A1-B1		

®	JMA [®]				
	HU-HCAP	CAPRI	F-11	P-11	
		CAPRI S.	F-11	P-11	
		NEO-DAKKI	F-11	P-11	
		XCODE	F-17W		
		MULTICODE	1F		A2-B2
	OP-11C3	CAPRI	F-11	P-11	
		CAPRI S.	F-11	P-11	
		NEO-DAKKI	F-11	P-11	
		XCODE	F-17W		
		MULTICODE	1F		A1-B1
HYUNDAI	HY-19P5	CAPRI	F-11	P-11	
		CAPRI S.	F-11	P-11	
		NEO-DAKKI	F-11	P-11	
	HY-19DP5	CAPRI	F-11	P-11	
		CAPRI S.	F-11	P-11	
		NEO-DAKKI	F-11	P-11	
HY-18P1C1	CAPRI	F-11	P-11		
	CAPRI S.	F-11	P-11		
	NEO-DAKKI	F-11	P-11		
HYUNDAI	HY-20.P	NEO-DAKKI	F-11	P-11	
		CAPRI S.	F-11	P-11	
		CAPRI	F-11	P-11	
IFAM	IF-8	CAPRI	F-19	P-19	
		CAPRI S.	F-19	P-19	
		NEO	F-19	P-19	
		X-CODE	F-19		
		MULTICODE	2F		C1-D1
	IF-9	CAPRI	F-19	P-19	
		CAPRI S.	F-19	P-19	
		NEO	F-19	P-19	
	IF-10D	CAPRI	F-19	P-19	
		CAPRI S.	F-19	P-19	
		NEO	F-19	P-19	
ITO	ITO-3D	CAPRI	F-1	P-1	
		CAPRI S.	F-1	P-1	
		NEO-DAKKI	F-1	P-1	
KESO	KE-6	CAPRI	F-1	P-1	
			FS-31	PS-31	
		CAPRI S.	F-1	P-1	
			FS-31	PS-31	
		NEO-DAKKI	F-1	P-1	
		FS-31	PS-31		

®	JMA [®]				
		X-CODE	F-49W		
		MULTICODE	10F		
KIA	KI-11P	CAPRI	F-11	P-11	
		CAPRI S.	F-11	P-11	
		NEO-DAKKI	F-11	P-11	
	KI-12P	CAPRI	F-11	P-11	
		CAPRI S.	F-11	P-11	
		NEO-DAKKI	F-11	P-11	
KI-12DP	CAPRI	F-11	P-11		
	CAPRI S.	F-11	P-11		
	NEO-DAKKI	F-11	P-11		
KTM	KM-1P	CAPRI	F-11	P-11	
		CAPRI S.	F-11	P-11	
		NEO-DAKKI	F-11	P-11	
		X-CODE	F-11W		
	MULTICODE	1F			
LINCE	LIN-26D	CAPRI	F-5	P-5	
		CAPRI S.	F-5	P-5	
		NEO-DAKKI	F-5	P-5	
		XCODE	F-5W		
MAUER	MAU-1	CAPRI	F-1	P-1	
		CAPRI S.	F-1	P-1	
		NEO-DAKKI	F-1	P-1	
	MAU-2	CAPRI	F-1	P-1	
		CAPRI S.	F-1	P-1	
		NEO-DAKKI	F-1	P-1	
MCM	MCM-15E8	CAPRI	F-1	P-1	
		CAPRI S.	F-1	P-1	
		NEO-DAKKI	F-1	P-1	
	MCM-45	CAPRI	F-13	P-13	
		CAPRI S.	F-13	P-13	
	NEO-DAKKI	F-13	P-13		
MEGA	MEG-1D	CAPRI	F-5	P-5	
		CAPRI S.	F-5	P-5	
		NEO-DAKKI	F-5	P-5	
MHA	MH-1	CAPRI	F-5	P-5	
		CAPRI S.	F-5	P-5	
		NEO-DAKKI	F-5	P-5	
MH	MH-2D	CAPRI	F-5	P-5	
		CAPRI S.	F-5	P-5	
		NEO-DAKKI	F-5	P-5	
MLM	MLM-8	CAPRI	F-3	P-3	

					
		CAPRI S.	F-3	P-3	
		NEO-DAKKI	F-3	P-3	
MOTTURA	MT-2D	CAPRI	F-5	P-5	
		CAPRI S.	F-5	P-5	
		NEO-DAKKI	F-5	P-5	
	MT-1P	CAPRI	F-1	P-1	
		CAPRI S.	F-1	P-1	
		NEO-DAKKI	F-1	P-1	
XCODE		F-27W			
MOTTURA	MT-2D.P	CAPRI	F-1	P-4	
		CAPRI S.	F-1	P-4	
		NEO	F-1	P-4	
OJMAR	OJ-20/4	CAPRI	F-1	P-1	
		CAPRI S.	F-1	P-1	
		NEO-DAKKI	F-1	P-1	
		XCODE	F-29W		
OMEC	OMC-3	CAPRI	F-1	P-1	
		CAPRI S.	F-1	P-1	
		NEO-DAKKI	F-1	P-1	
		XCODE	F-1W		
	OMC-7	CAPRI	F-1	P-1	
		NEO-DAKKI	F-1	P-1	
POTENT	PTN-2D	CAPRI	F-19	P-19	
		CAPRI S.	F-19	P-19	
		NEO-DAKKI	F-19	P-19	
	PTN-3D	CAPRI	F-19	P-19	
		CAPRI S.	F-19	P-19	
		NEO-DAKKI	F-19	P-19	
PREFER	PR-21	CAPRI	F-5	P-5	
		CAPRI S.	F-5	P-5	
		NEO-DAKKI	F-5	P-5	
	PR-22	CAPRI	F-5	P-5	
		CAPRI S.	F-5	P-5	
		NEO-DAKKI	F-5	P-5	
SEA	SEA-2	CAPRI	F-1	P-1	
		CAPRI	F-3	P-3	
		CAPRI S.	F-1	P-1	
		CAPRI S.	F-3	P-3	
		NEO-DAKKI	F-1	P-1	
		NEO-DAKKI	F-3	P-3	
STANDERS	STN-1D	CAPRI	F-5	P-5	

					
		CAPRI S.	F-5	P-5	
		NEO-DAKKI	F-5	P-5	
TECON	TC-3	CAPRI	F-5	P-5	
		CAPRI S.	F-5	P-5	
		NEO-DAKKI	F-5	P-5	
		XCODE	F-5W		
TESA	TE-T80EH	CAPRI	F-5	P-5	
		CAPRI S.	F-5	P-5	
		NEO-DAKKI	F-5	P-5	
		XCODE	F-5W		
TITAN	TIT-22	CAPRI	F-19	P-19	
		CAPRI S.	F-19	P-19	
		NEO	F-19	P-19	
	TIT-23	CAPRI	F-19	P-19	
		CAPRI S.	F-19	P-19	
		NEO	F-19	P-19	
	TIT-25	CAPRI	F-1	P-1	
		CAPRI S.	F-1	P-1	
		NEO	F-1	P-1	
		X-CODE	F-19		
	MULTICODE	2F		C1-D1	
TOYOTA	TOYO-41P	CAPRI	F-11	P-11	
		CAPRI S.	F-11	P-11	
		NEO	F-11	P-11	
TOVER	TOV-4	CAPRI	F-1	P-1	
		CAPRI S.	F-1	P-1	
		NEO-DAKKI	F-1	P-1	
		XCODE	F-1W		
TRELOCK	TRL-4P	CAPRI	F-11	P-11	
		CAPRI S.	F-11	P-11	
		NEO-DAKKI	F-11	P-11	
UCEM	UCEM-20D	CAPRI	F-6	P-6	
		CAPRI S.	F-6	P-6	
		NEO-DAKKI	F-6	P-6	
		XCODE	F-6		
UCEM	UCEM-21	CAPRI	F-19	P-19	
		CAPRI S.	F-19	P-19	
		NEO	F-19	P-19	
		MULTICODE	2F		C1 - D1
		XCODE	F-19W		
VACHETTE	VA-91	CAPRI	F-1	P-1	
		CAPRI S.	F-1	P-1	
		NEO-DAKKI	F-1	P-1	

					
VALEO	<i>CIT-1C1</i>	<i>CAPRI</i>	<i>F-11</i>	<i>P-11</i>	<i>AD-VAX</i>
		<i>CAPRI S.</i>	<i>F-11</i>	<i>P-11</i>	
		<i>NEO-DAKKI</i>	<i>F-11</i>	<i>P-11</i>	
		<i>XCODE</i>	<i>F-17W</i>		
		<i>MULTICODE</i>	<i>1F</i>		
YALE	<i>YA-281D</i>	<i>CAPRI</i>	<i>F-5</i>	<i>P-5</i>	
		<i>CAPRI S.</i>	<i>F-5</i>	<i>P-5</i>	
		<i>NEO-DAKKI</i>	<i>F-5</i>	<i>P-5</i>	
	<i>YA-280D</i>	<i>CAPRI</i>	<i>F-5</i>	<i>P-5</i>	
		<i>CAPRI S.</i>	<i>F-5</i>	<i>P-5</i>	
		<i>NEO-DAKKI</i>	<i>F-5</i>	<i>P-5</i>	
	<i>YA-282</i>	<i>CAPRI</i>	<i>F-5</i>	<i>P-5</i>	
		<i>CAPRI S.</i>	<i>F-5</i>	<i>P-5</i>	
		<i>NEO-DAKKI</i>	<i>F-5</i>	<i>P-5</i>	
		<i>X-CODE</i>	<i>F-19</i>		
		<i>MULTICODE</i>	<i>2F</i>		
	<i>YA-283D</i>	<i>CAPRI</i>	<i>F-19</i>	<i>P-19</i>	
		<i>CAPRI S.</i>	<i>F-19</i>	<i>P-19</i>	
<i>NEO</i>		<i>F-19</i>	<i>P-19</i>		
YALE (ORIG.)	<i>YA-306</i>	<i>CAPRI</i>	<i>F-5</i>	<i>P-5</i>	
		<i>CAPRI S.</i>	<i>F-5</i>	<i>P-5</i>	
		<i>NEO</i>	<i>F-5</i>	<i>P-5</i>	
		<i>MULTICODE</i>	<i>2F</i>		<i>A1 - D1</i>
		<i>XCODE</i>	<i>F-5W</i>		
YARDENI	<i>YAR-3</i>	<i>CAPRI</i>	<i>F-13</i>	<i>P-13</i>	
		<i>CAPRI S.</i>	<i>F-13</i>	<i>P-13</i>	
		<i>NEO-DAKKI</i>	<i>F-13</i>	<i>P-13</i>	
YETI	<i>YET-18</i>	<i>CAPRI</i>	<i>F-5</i>	<i>P-5</i>	
		<i>CAPRI S.</i>	<i>F-5</i>	<i>P-5</i>	
		<i>NEO</i>	<i>F-5</i>	<i>P-5</i>	
	<i>YET-19D</i>	<i>CAPRI</i>	<i>F-5</i>	<i>P-5</i>	
		<i>CAPRI S.</i>	<i>F-5</i>	<i>P-5</i>	
		<i>NEO</i>	<i>F-5</i>	<i>P-5</i>	

PLANAS

FLAT

ABLOY	ABL-3D	AVANTCODE	FP-27		AV2

MÁQUINAS MACHINES

FRESAS CUTTERS

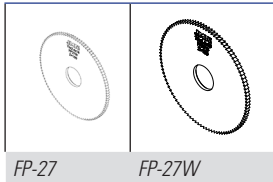

FP-27 FP-27W

ADAPTADORES ADAPTORS

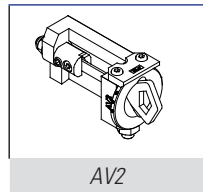

AV2

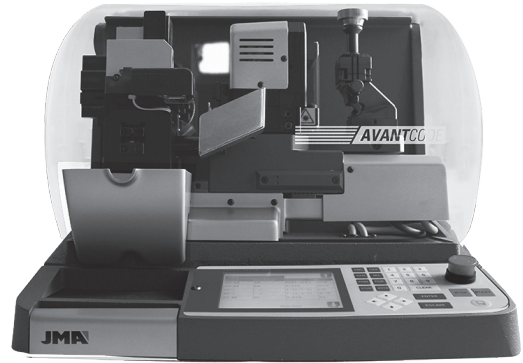

AVANTCODE

GORJA BIT

ABLOY	ABL-3D	SARATOGA		ABL-S	
		TITANBIT		TIB-ABL	
		ECCOABLOY		ABL-E	
DENNY	DEN-1	SENA		AD-DEN	

ADAPTADORES ADAPTORS

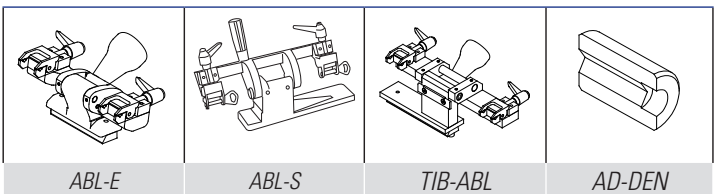

ABL-E ABL-S TIB-ABL AD-DEN

MÁQUINAS MACHINES

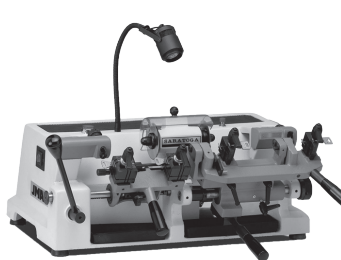

SARATOGA

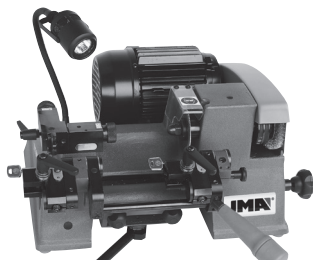

TITAN BIT



ECCO ABLOY



SENA

JMA FRANCE

JMA FRANCE SAS
Tel +33 01 39 22 42 10
Fax +33 01 39 22 42 11
Technoparc
13, rue Edouard Jeanneret
F- 78306 Poissy Cedex
www.jmafrance.fr
service.commercial@jmafrance.fr

JMA POLSKA

JMA POLSKA Sp. z o.o.
Tel +48 42 635 12 80
Fax +48 42 635 12 85
91- 342 Łódź, ul. Zbąszyńska 3
www.jmapolska.pl
biuro@jmapolska.pl

JMA PORTUGAL

ALTUNA PORTUGAL
COMERCIO DE CHAVES UNIPessoal, LDA.
Tel +351 219 947 470
Fax +351 219 947 471
Rua de Goa N°22
2690-356 Santa Iria de Azoia
www.jmaportugal.com
comercial@jmaportugal.com

JMA UK

SKS LTD
Tel +44 144 229 1400
Fax +44 144 286 3683
Unit 2, Canalside Northbridge Road
Berkhamsted
Herts HP4 1EG
www.jmakeys.co.uk
sales@skskeys.co.uk

JMA MAROC

JMA MAROC S.A.R.L.
Tel +0520 150 535
Fax +0520 150 536
83,85 Bd Oued ZIZ, El Oulfa
Casablanca
www.jma.ma
jma@jma.ma

JMA INDIA

JMA KEYS INDIA PVT. LTD
Tel +91 124 428 5450
Fax +91 124 428 5451
H-239 & H-240, Sushant Shopping Arcade
Sushant Lok-1, Block B
122002 Gurgaon (Haryana)
www.jmakeys.in
info@jmakeys.in

JMA MEXICO

LLAVES ALTUNA DE MEXICO S.A de C.V
Tel +52 33 3777 1600
Fax +52 33 3777 1609
Av. Aviación No. 5520
Col. San Juan de Ocotán
C.P. 45019 Zapopan, Jalisco
www.jma.com.mx
ventas@jma.com.mx

JMA PERU

JMA PERU S.A.C.
Tel +51 639 9300
Av. Los Paracas 130,
Urbanización Salamanca,
Distrito Ate, Lima
www.jma-peru.com
info@jma-peru.com

JMA COLOMBIA

IFAM - JMA Colombia, S.A.S.
Tel +57 1 53333246
Fax +57 3203497446
Diagonal 115A - 70B - 45 Local 1
Bogotá
www.jmacolombia.com
info@jmacolombia.com

JMA SPAIN

JMA ALEJANDRO ALTUNA, S.L.U.
Tel +34 943 79 30 00
Fax +34 943 79 72 43
Bidekurtzeta, 6 P.O.Box - Apdo. 70
20500 Arrasate - Mondragón
Gipuzkoa - SPAIN
www.jma.es
jma@jma.es

JMA USA

ALTUNA GROUP USA INC.
Tel +1 817 385 0515
Fax +1 817 385 4850
1513 Greenview Drive
75050 Grand Prairie
Texas
www.jmausa.com
info@jmausa.com

JMA ARGENTINA

JMA ARGENTINA S.A.
Tel +54 336 4 462 422
Fax +54 336 4 462 422
Av. Central Acero Argentino Oeste 678
COMIRSA - 2900 San Nicolas
www.jma.com.ar
info@jma.com.ar

JMA URUGUAY

JMA URUGUAY S.A.
Tel +598 2908 1175
Fax +598 2900 6681
Mercedes 1420
11100 Montevideo
www.jma.com.uy
info@jma.com.uy

JMA WORLDWIDE

ALTUNA GROUP HEADQUARTERS

Tel +34 943 79 30 00
Fax +34 943 79 72 43
Bidekurtzeta, 6 P.O.Box - Apdo. 70
20500 Arrasate - Mondragón
Gipuzkoa - SPAIN
www.altuna.com

