

**JMA**®

***C11.2021***

***SUPLEMENTO  
SUPPLEMENT***





**A2 JMA es Compromiso**

JMA Konpromisoa da  
JMA is Commitment  
JMA, l'engagement  
JMA bedeutet Verpflichtung

**A3-A5 Nuevos Productos**

New Products  
Produktu berriak  
Nouveaux produits  
Neue Produkte

**A6-A7 Aviso Legal**

Mezu Legala  
Legal Warning  
Informations Légales  
Rechtliche Hinweise

**A8-A9 Descripción y Terminología**

Deskribapen eta Terminologia  
Description and Terminology  
Description et Terminologie  
Begriffserklärung und Terminologie

**A10-A11 Símbolos y Nacionalidades**

Ikur eta Nazionalitateak  
Symbols and Nationalities  
Symboles et Nationalités  
Symbole und Nationalitäten

**A13-A16 ÍNDICES**  
AURKIBIDEA  
INDEX  
INDEX  
GESAMTVERZEICHNIS

**A14-A15 Índice General**

Aurkibidea  
General Index  
Index Generale  
Gesamtverzeichnis

**A16 Índice de Marcas**

Marken Aurkibidea  
Brand Index  
Index Marque  
Hauptmarke

**1-37 LLAVES**  
GILTZAK  
KEYS  
CLÉS  
SCHLÜSSEL

**1 - 37 Imágenes de Llaves**

Giltzen Irudiak  
Keys Images  
Images Clés  
Schlüssel Bilder

**B1 - B7 CAT. ESPECIALISTA DE MÁQUINAS DUPLICADORAS**  
KOPIATZEKO MAKINEN GIDA ESPEZIALISTA  
KEY CUTTING SPECIALIST'S GUIDE  
SPÉCIALISTE CATALOGUE DE MACHINES DUPLICATRICES  
SPEZIALISTKATALOG

**NUESTRO ÉXITO ESTÁ BASADO EN  
EL COMPROMISO DE LAS PERSONAS**

*Alejandro Altuna S.L.U es la sociedad matriz e impulsora de Altuna Group. Fabrica todo tipo de llaves para cerradura así como máquinas duplicadoras. Sus productos van destinados al mercado OEM y a la reposición, en este caso con la marca JMA.*

*Fundada por el Sr. Alejandro Altuna en 1942 arrancó su actividad en Mondragón. Posteriormente, la estrategia de apertura de mercados exteriores apoyada en la internacionalización y siempre basada en un enfoque innovador de los procesos industriales, ha convertido a ALTUNA GROUP en el primer productor de llaves europeo y referente mundial en este campo.*

*Actualmente, 15 compañías en 4 continentes trabajan conjuntamente para el desarrollo y potenciación de la fuerza de nuestra marca JMA, conocida en más de 100 países en todo el mundo.*

*JMA integra equipos de personas comprometidas y motivadas por un proyecto común que nos ha permitido ser el mayor fabricante de llaves de Europa.*

**OUR SUCCESS IS BASED ON  
OUR PEOPLE'S COMMITMENT**

*Alejandro Altuna S.L.U. is the parent company and driving force behind the Altuna Group. It manufactures all types of lock-keys and key-cutting machines. Its products are for the OEM and replacement markets, in the latter case with the JMA brand.*

*Set up by Alejandro Altuna in 1942, it started the production in Mondragón (Spain). Later, the strategy of opening up to foreign markets backed by globalisation and always based on an innovative attitude towards industrial processes, turned the ALTUNA GROUP into the largest producer of keys in Europe and a benchmark worldwide in the field.*

*Currently 15 companies in four continents work together to develop the strength of our JMA brand, well known in more than 100 countries all over the world.*

*This successful trail that led us to be the biggest key producer in Europe is based in our people's commitment to be:*

**LIDER EN TECNOLOGÍA:**

*Una apuesta sólida por la calidad y la innovación basada en la automatización y garantía de procesos y soportada por una vocación inversora a largo plazo.*

**THE LEADER IN TECHNOLOGY,**

*looking for the latest developments to improve the production processes together with a strong investment policy in all our plants to ensure the company's competitiveness and long-term future.*

**LIDER EN CALIDAD:**

*Nuestra política de calidad se basa en la prevención y planificación, mejora continua, satisfacción del cliente y participación de las personas. Además de la Certificación en Calidad de acuerdo a la ISO 9001, Alejandro Altuna S.L.U. acoge Sistemas de Gestión de la Calidad homologados por las empresas líderes del sector de automoción y residencial.*

**THE LEADER IN QUALITY:**

*Our quality policy is based on prevention and planning, continuous improvement, customer satisfaction and people participation. In addition to Quality Certification to ISO 9001, Alejandro Altuna S.L.U. operates Quality Management Systems approved by the leading companies in the automotive and residential sectors.*

**LIDER EN EL COMPROMISO  
POR EL MEDIO AMBIENTE:**

*En Alejandro Altuna S.L.U. las buenas prácticas medioambientales son la norma y no la excepción. Nuestro equipo forma parte de un proyecto de empresa respetuoso con el medioambiente y que colabora con el desarrollo sostenible de nuestro entorno. Alejandro Altuna S.L.U. fue el primer fabricante mundial de llaves en conseguir en 2000 el certificado ISO 14001 para su Sistema de Gestión.*

**THE LEADER IN THE  
COMMITMENT TO THE ENVIRONMENT:**

*At Alejandro Altuna S.L.U. best environmental practice is the norm and not the exception. Our team is part of a business project that respects the environment and contributes to the sustainable development of our community. Alejandro Altuna S.L.U. was the first key manufacturer in the world to achieve ISO 14001 certification for its management system in 2000.*

**LIDER EN SERVICIO:**

*La realidad de una empresa se demuestra en su capacidad por responder con la máxima celeridad y eficacia a las necesidades y exigencias de los clientes. Se encuentren donde se encuentren. Además, gracias a su amplia red de filiales y empresas distribuidoras repartidas por todo el mundo, le permite llegar a cualquier cliente, se cual sea su ubicación.*

**THE LEADER IN SERVICE,**

*The efficiency of a company is shown in its capacity to respond with the maximum speed and effectiveness to the needs and requirements of its customers, wherever they are based. Moreover, with its extensive network of associate and distribution companies located throughout the world, the company can reach any customer, wherever based.*

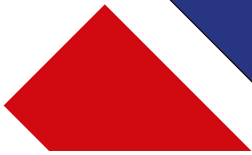

**NEW**

# LA PLATAFORMA FORMATIVA ONLINE PARA PROFESIONALES DEL DUPLICADO

THE ONLINE TRAINING  
PLATFORM FOR DUPLICATION  
PROFESSIONALS

# ETRAINING. JMA.ES

## EVENTOS EN DIRECTO LIVE EVENTS

**Webinars, presentaciones de nuevos productos y mucho más...**  
*Webinars, new product introductions and much more...*

## VIDEO TUTORIALES VIDEO TUTORIALS

**Desde los aspectos más básicos a los más avanzados**  
*Starting from the basics to reach the most advanced aspects*

## PERSONALIZA TU EXPERIENCIA CUSTOMISE YOUR EXPERIENCE

**Crea tu propia portada y recibirás actualizaciones de los contenidos que más te interesan**  
*Create your own home page and receive updates on the contents of your interest*

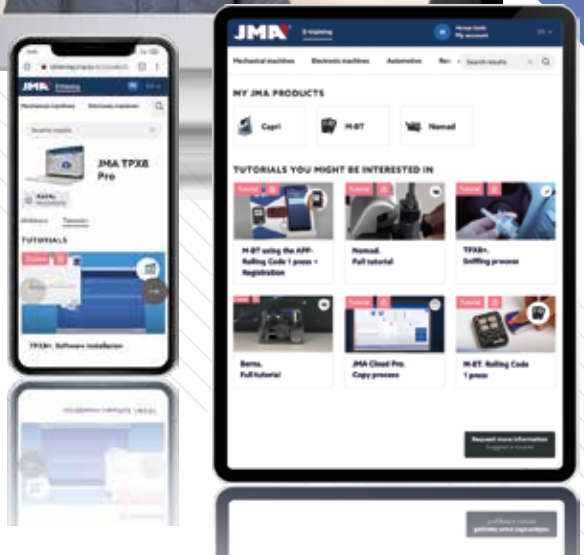

**¡REGÍSTRATE  
AHORA!**

**Para acceder a  
contenido  
exclusivo**

**¡REGISTER  
NOW!**

*To access  
exclusive content*



# JMA®

# BT MULTI USER PRO



## EL TELEMANDO EN TU SMARTPHONE

AHORA, CON CAPACIDAD PARA MÁS DE 100 USUARIOS

## THE REMOTE CONTROL ON YOUR SMARTPHONE

NOW IT CAN BE USED BY OVER 100 DIFFERENT USERS

*BT MULTIUSER, el sistema JMA para apertura de puertas de garaje, vallas y puertas de acceso con el teléfono móvil, evoluciona con la llegada de BT MULTIUSER PRO.*

*Ahora podrá gestionar y enviar permisos de apertura de un mismo acceso a más de 100 usuarios. Además, cuenta con una nueva base de alimentación con resistencia a la intemperie IP66.*

*BT MULTIUSER - the JMA system for opening garage doors, gates and access doors using your smartphone - has been taken to the next level with BT MULTIUSER PRO.*

*Now you can manage and send access permissions for a single point of access to over 100 different users. The new power base also comes with an IP66 protection rating.*

### PACKS DISPONIBLES / AVAILABLE PACKS

ADMIN



ADMINISTRADORES + USUARIOS INVITADOS / ADMINISTRATORS + GUEST USERS

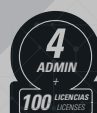
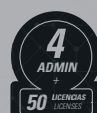



# BT SLIM

**BT SLIM es el nuevo telemando JMA para la apertura de puertas de garaje, vallas y puertas acceso mediante teléfono móvil. Basta con colocar el dispositivo en la parte trasera de su smartphone, vincularlo vía Bluetooth a la APP JMARemoteSLIM y pulsar en ella el botón de apertura.**

**Gracias a su diseño fino y ligero, BT SLIM se lleva cómodamente en el móvil y se guarda en cualquier bolsillo. Además, incorpora otros atractivos como la función de disparador remoto de la cámara de fotos del teléfono y otros extras que harán más cómodo el manejo de su smartphone.**

*BT SLIM is the new JMA remote control for opening garages, gates and other doors using your mobile. Simply attach the device to the rear of your smartphone, connect via Bluetooth to the JMARemoteSLIM app and press the open button.*

*Thanks to its thin lightweight design, BT SLIM can be attached to your mobile comfortably and kept in any pocket. It also offers a number of other attractive features, such as a remote mobile camera shutter button and other extras that will make using your smartphone more convenient.*



## SENCILLO MANEJO MEDIANTE APPS

SIMPLE TO USE VIA ITS APPS

## 4 MANDOS EN 1

4 REMOTES IN 1

## LIGERO Y FÁCIL DE LLEVAR

LIGHTWEIGHT AND EASY TO CARRY

**BT Slim se maneja mediante dos APPs:**

- JMARemotesPRO, para el duplicado de los mandos originales en el BT Slim
- JMARemoteSLIM, para la apertura de puertas de garaje, vallas y puertas de acceso.

*BT Slim can be used via two apps:*

- JMARemotesPRO for duplicating original remote controls on the BT Slim
- JMARemoteSLIM for opening garages, gates and other doors.

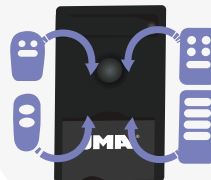

**Copia el 95% de los códigos fijos y más de 40 marcas Rolling Code.**  
*It copies 95% of fixed codes and more than 40 rolling code brands.*

**Péguelo en la parte trasera de su smartphone. Es tan fino que se lleva fácilmente en el bolsillo del pantalón, en bolsos pequeños, chaquetas, etc.**

*Attach it to the rear of your smartphone. It's so thin that it easily fits in your trouser pocket, in small bags, jackets, etc.*

## ÚSELO TAMBIÉN COMO UN TELEMANDO TRADICIONAL

USE IT ALSO AS A TRADITIONAL REMOTE CONTROL

## DISPARADOR DE CÁMARA DE FOTOS

REMOTE CAMERA SHUTTER BUTTON

## ESPAÑOL

### AVISO LEGAL - SUPLEMENTO C11.2021

Las llaves que aparecen en este catálogo son piezas JMA fabricadas por JMA Alejandro Altuna S.L.U. o un subcontratista de éste. Están diseñadas para cilindros y cerraduras de los fabricantes cuyas marcas se indican en este catálogo.

Conforme a las disposiciones legales vigentes relativas a la propiedad industrial, las marcas o nombres comerciales indicados en este catálogo son propiedad exclusiva de los fabricantes de cilindros y cerraduras, así como de los fabricantes de automóviles, otros constructores, distribuidores y usuarios.

Dichas marcas o nombres comerciales se indican en calidad simplemente informativa con el fin de reco-

nocer con rapidez la cerradura a la que corresponden nuestras piezas.

Este catálogo está reservado exclusivamente a profesionales de la reproducción de llaves que utilizan piezas JMA.

Los datos referentes a los productos de este catálogo tienen carácter indicativo. Manteniendo siempre las características básicas, nos reservamos el derecho de realizar, sin previo aviso, modificaciones técnicas, estéticas o de otro tipo, por razones de evolución de los productos en cuestión.

Algunos modelos que están en este nuevo catálogo podrán recibirlos tanto con la marca y la referencia JMA como con otra marca del grupo ALTUNA.

## EUSKERA

### LEGE-OHARRA - C11.2021 SUPLEMENTO A

Katalogo honetan ageri diren giltzak Alejandro ALTUNA SLU enpresak edo honek kontratatutako beste enpresabatekegin-dako JMA piezak dira. Katalogoan zehazten diren marken fabrikatzaileen zilindro eta sarrailetarako diseinatuta daude.

Jabetza industrialari buruz indarrean dauden lege-xedape-nekin bat etorri, katalogo honetan zehaztutako merkataritza-markak edo izenak zilindro eta sarraileen fabrikatzaileen nahiz ibilgailuen fabrikatzaileen eta beste erakitzailen, banatzaile eta erabiltzaile batzuen jabetza eskusibokoak dira.

Merkataritza-marka edo izen horiek zehaztasun gehiago emateko adierazten dira, gure piezak zein sarraileri dagozkion berehala ikusi ahal izateko.

Katalogo hau giltzen kopia egiteko JMA piezak erabiltzen dituzten profesionalentzako da soilik.

Katalogo honetako produktuei buruzko datuek izaera adierazgarria dute. Oinarriko ezaugarriak gordez, produktuen bilakaeraren ondoriozko aldaketak teknikoak, estetikoak edo bestelakoak egiteko eskubidea dugu, aurretik horren berri eman beharrik gabe.

Katalogo berri honetan dauden eredueta batak JMA marka eta erreferentziarekin nahiz ALTUNA taldeko beste marka batekin jaso ahal izango dira.

## ENGLISH

### LEGAL WARNING - SUPPLEMENT C11.2021

The keys that appear in this catalogue are JMA parts manufactured by JMA Alejandro Altuna S.L.U. or one of its subcontractors. They are designed for cylinders and locks made by the manufacturers whose trademarks are indicated in this catalogue.

In accordance with legal requirements relating to industrial property rights, the trademarks or trade names indicated in this catalogue are the exclusive property of the manufacturers of the cylinders and locks, as well as automobile manufacturers, other constructors, distributors and users.

The aforementioned trademarks or trade names are indicated simply for information purposes so that the lock to which our parts correspond can be recognised quickly and easily. This catalogue is for the exclusive use of professional key copiers who use JMA parts.

Data referring to the products in this catalogue are indicative in nature. Although the basic characteristics are maintained at all times, we reserve the right to make, without previous notice, any technical, aesthetic or other types of changes involved in the development of the products in question. Some of the keys in this new catalogue could be received either with the JMA reference and trademark or with another trademark from the ALTUNA group.

## FRANÇAIS

### MENTIONS LEGALES - SUPPLEMENT C11.2021

Les ébauches de clés reportées sur ce catalogue sont des ébauches JMA fabriquées par JMA Alejandro Altuna S.L.U. ou un de ses sous-traitants. Elles sont destinées aux cylindres et serrures des fabricants dont les marques sont indiquées dans ce catalogue.

Conformément aux dispositions légales en vigueur relatives à la propriété industrielle, les marques ou les dénominations commerciales citées dans ce catalogue sont la propriété exclusive des fabricants de cylindres et de serrures ainsi que des constructeurs de voitures, autres constructeurs, distributeurs et utilisateurs.

Ces marques ou dénominations commerciales sont indiquées à titre de simple information afin de connaître rapidement à quelle serrure nos ébauches sont destinées.

Ce catalogue est exclusivement réservé aux professionnels de la reproduction de clés, utilisant des ébauches JMA.

Les renseignements sur les produits de ce catalogue sont donnés à titre indicatif. Tout en gardant les caractéristiques de base, nous nous réservons le droit d'apporter, sans préavis, des modifications techniques, esthétiques ou autres, dues à l'évolution des produits en question.

Des ébauches de ce catalogue pourront être livrées soit avec la marque et référence JMA soit avec une autre marque du groupe ALTUNA.

## DEUTSCH

### RECHTSHINWEIS- NACHTRAG C11.2021

Die in dem vorliegenden Katalog aufgeführten Schlüssel sind JMA-Teile, die von der Firma Alejandro ALTUNA, S.L.U., einem Zulieferanten von JMA, hergestellt werden. Sie sind für Zylinder und Schlösser derjenigen Hersteller entwickelt worden, deren Marken in diesem Katalog aufgeführt sind.

In Übereinstimmung mit den geltenden gesetzlichen Vorschriften bezüglich des gewerblichen Eigentums sind die im vorliegenden Katalog aufgeführten Marken und Firmennamen ausschließliches Eigentum der Zylinder- und Schloßhersteller, sowie der Automobilhersteller und anderer Konstrukteure, Vertrieber und Benutzer.

Diese Marken und Firmennamen werden nur zu Informationszwecken aufgeführt, mit dem Ziel, auf schnelle Weise zu erkennen, zu welchem Schloß unsere Teile gehören.

Dieser Katalog ist ausschließlich für Fachleute des Bereichs der Schlüsselreproduktion gedacht, die JMA-Teile verwenden.

Die Daten bezüglich der Produkte des vorliegenden Katalogs haben informativen Charakter. Bei Aufrechterhaltung der grundlegenden Eigenschaften behalten wir uns das Recht vor, aus Gründen der Entwicklung der entsprechenden Produkte und ohne Vorankündigung technische, ästhetische oder andere Änderungen vorzunehmen. Einige Modelle des neuen Katalogs können Sie sowohl mit der Marke und der Bezeichnung JMA erhalten, als auch mit jeder anderen Marke der Gruppe ALTUNA.

**THE KEY TO EXCELLENCE**  
GLOBALLY UNLOCKING MILLIONS OF DOORS DAILY





# MANUAL DE USO

## MANUAL OF USE

### ESPAÑOL

#### MANUAL DE USO

Todas las llaves del catálogo están en escala 1:1; tanto la silueta como el perfil, para hacer una búsqueda más fácil y precisa. Pasos a seguir para la identificación de la llave:

**1. Identificación de la silueta:** Confirmar que la llave que busca coincide con las dimensiones de la llave catálogo. Ver Fig. 1

**2. Identificación del perfil:**

**2.1** Ver si el perfil de la llave y el perfil del catálogo forman una misma imagen. Ver Fig. 2.1

**2.2** Cerciorar que el perfil del catálogo tiene la misma forma y dimensión, colocando la llave física sobre la imagen del catálogo. Ver Fig. 2.2

### EUSKERA

#### ERABILERA-ESKULIBURUA:

Katalogoko giltza guztiak 1:1 eskalan agertzen dira; hala silueta nola profila, bilaketa errazagoa eta zehatzagoa izan dadin. Giltza identifikatzeko urratsak:

**1. Silueta identifikatzea:** Bilatzen den giltzak katalogoan agertzen den giltzaren dimentsio bera duela baieztatu. Ikus 1. irudia.

**2. Profila identifikatzea:**

**2.1.** Giltzaren profilak eta katalogoko profilak irudi bera osatzen duten ikusi. Ikus 2.1. irudia.

**2.2.** Katalogoko profilak forma eta dimentsio bera duela ziurtatzea, giltza fisikoa katalogoko irudiaren gainean jarri. Ikus 2.2. irudia.

### ENGLISH

#### MANUAL OF USE

All the keys in this catalogue are 1:1 scale; both the silhouette outline and profile, to facilitate a precise search. Steps to follow for identifying the key:

**1. Identification of the silhouette:** Confirm that the key you want matches with the dimensions of the key in the catalogue. See Fig. 1

**2. Identification of the profile:**

**2.1.** Check to see if the profile of the original key and the profile in the catalogue have a similar shape. See Fig. 2

**2.2.** Make sure the profile of the catalogue has the same shape and dimension, by placing the physical key over the image in the catalogue. See Fig. 2.2

### FRANÇAIS

#### MANUEL D'UTILISATION

Toutes les clés du catalogue sont à l'échelle 1:1; aussi bien la silhouette que le profil, afin de permettre une recherche plus simple et précise. Étapes à suivre pour l'identification de la clé :

**1. Identification de la silhouette :** Confirmer que la clé recherchée correspond aux dimensions de la clé du catalogue. Voir Fig.1

**2. Identification du profil :**

**2.1.** Voir si le profil de la clé correspond au profil du catalogue. Voir Fig.2.1

**2.2.** S'assurer que le profil du catalogue a la même forme et les mêmes dimensions, en plaçant la clé physique sur l'image du catalogue. Voir Fig.2.2

### DEUTSCH

#### HANDBUCH

Alle Schlüssel im Katalog sind im Maßstab 1:1 dargestellt, sowohl als Silhouette als auch im Profil, um die Suche leichter und genauer zu machen. Zu befolgende Schritte für die Identifizierung des Schlüssels:

**1. Identifizierung der Silhouette:** Bestätigung, dass der gesuchte Schlüssel mit dem Abmessungen im Katalog übereinstimmt. Siehe Abb. 1

**2. Identifizierung des Profils:**

**2.1.** Prüfen, ob das Profil des Schlüssels und das im Katalog gezeigte Profil übereinstimmen. Siehe Abb. 2.1

**2.2.** Vergewissern, dass das Profil im Katalog die gleiche Form und Größe hat, indem man den tatsächlichen Schlüssel auf das Katalogbild legt. Siehe Abb. 2.2

## IDENTIFICACIÓN DE LA LLAVE

### KEY IDENTIFICATION

#### 1. Identificación de la Silueta

Silhouette identification

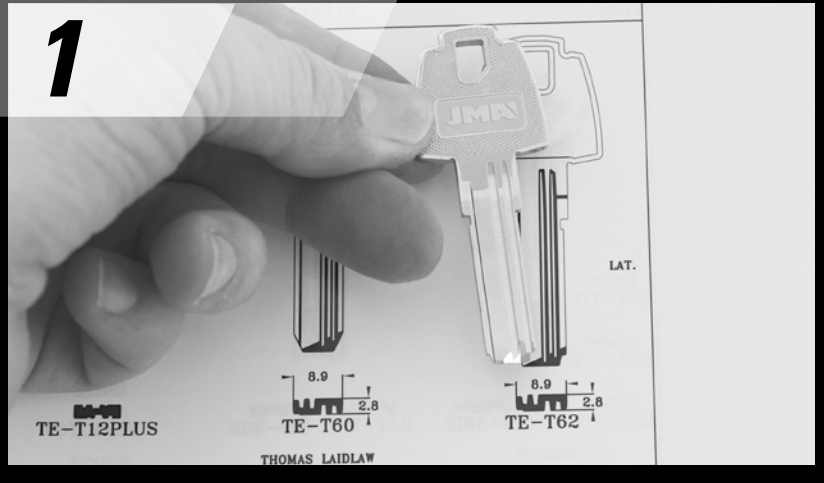

#### 2. Identificación del perfil

Identification of the profile

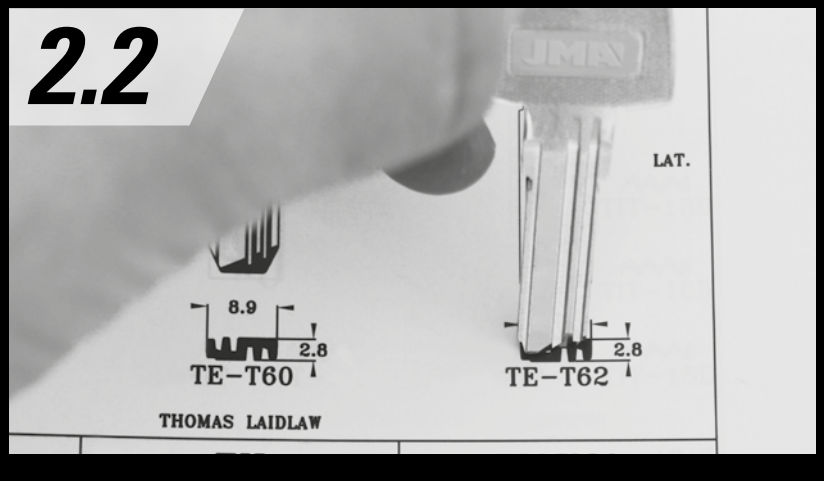
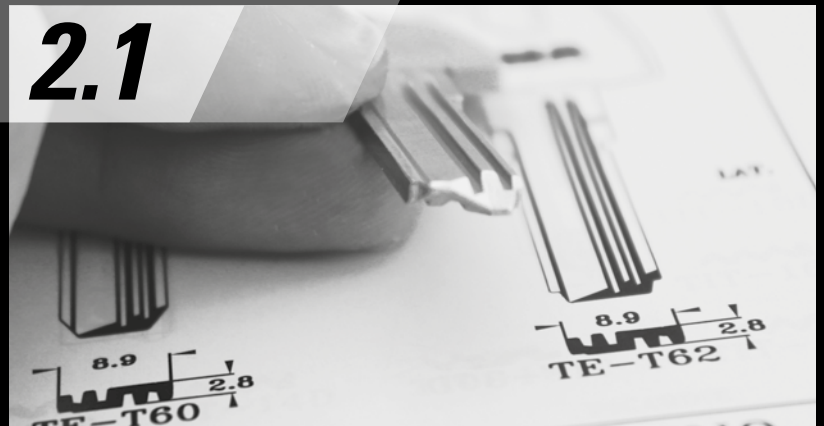

## ESPAÑOL

- 1 — MARCA PRINCIPAL
- 2 — CABEZA
- 3 — CUELLO
- 4 — TOPE
- 5 — PALETÓN
- 6 — PUNTA
- 7 — UTILIZACIÓN
- 8 — NOMENCLATURA DE PERFIL ORIGINAL
- 9 — PERFIL IZQUIERDO
- 10 — PERFIL DERECHO
- 11 — REFERENCIA
- 12 — MARCAS SECUNDARIAS
- 13 — SERIES
- 14 — MARCA PRINCIPAL
- 15 — MARCAS SECUNDARIAS DE LA PRINCIPAL (ABSA)

## 1 — FOR: ABSA<sup>®</sup>

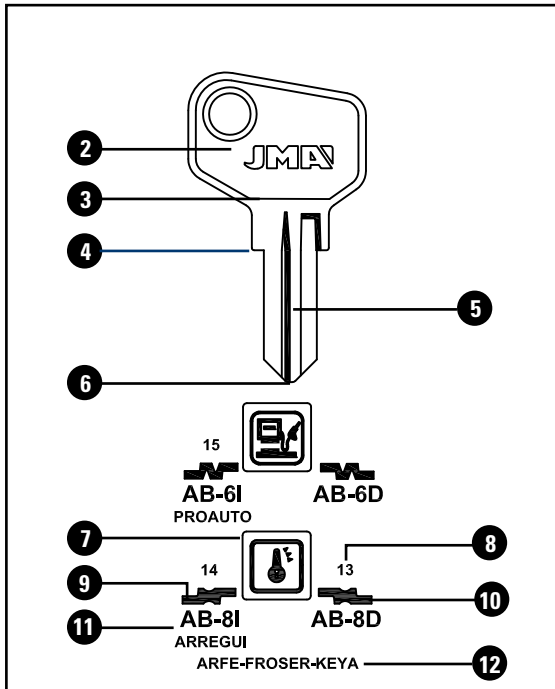

## 1 — FOR: VACHETTE<sup>®</sup>

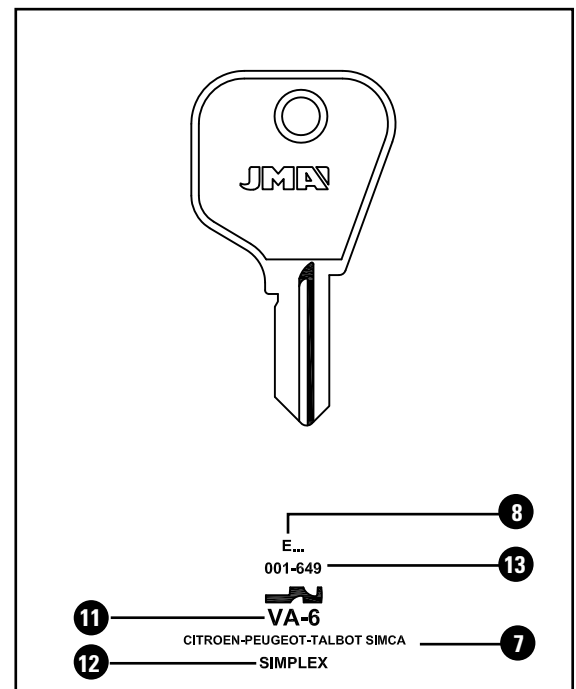

EUSKERA	ENGLISH	FRANÇAIS	DEUTSCH
1 MARKA NAGUSIA	1 MAIN BRAND	1 MARQUE PRINCIPALE	1 HAUPTPRÄGUNG
2 BURUA	2 HEAD	2 TÊTE	2 KOPF
3 LEPOA	3 NECK	3 COU	3 HALS
4 TOPEA	4 SHOULDER	4 ARRÊT	4 ANSCHLAG
5 BELARRIA	5 BLADE	5 CANON	5 SCHAFT
6 PUNTA	6 TIP	6 POINTE	6 SPITZE
7 ERABILERA	7 USE	7 UTILISATION	7 VERWENDUNG
8 JATORRIZKO PROFILAREN IZENDEGIA	8 ORIGINAL PROFILE	8 PROFIL ORIGINAL	8 ORIGINALPROFIL
9 EZKERREKO PROFILA	9 LEFT PROFILE	9 PROFIL GAUCHE	9 LINKSPROFIL
10 ESKUINEKO PROFILA	10 RIGHT PROFILE	10 PROFIL DROIT	10 RECHTSPROFIL
11 ERREFERENTZIA	11 REFERENCE	11 RÉFÉRENCE	11 BEZEICHNUNG
12 BIGARREN MAILAKO MARKAK	12 SECONDARY BRAND	12 MARQUE SECONDAIRE	12 2. PRÄGUNG
13 SERIEAK	13 SERIES	13 CODE	13 SERIE
14 MARCA NAGUSIA ETA JATORRIZKOA	14 MAIN BRAND AND NATIONALITY	14 MARQUE PRINCIPALE ET NATIONALITÉ	14 HAUPTPRÄGUNG UND NATIONALITÄT
15 MARKA NAGUSIAREN BIGARREN MAILAKO MARKAK (ABSA)	15 SECONDARY BRANDS OF THE MAIN ONE (ABSA)	15 MARQUES SECONDAIRES DE LA PRINCIPALE (ABSA)	15 2. PRÄGUNG FÜR HAUPTPRÄGUNG (ABSA)

# DESCRIPCIÓN Y TERMINOLOGÍA

## KEY DESCRIPTION AND TERMINOLOGY

### ESPAÑOL

- 1 CABEZA
- 2 CUELLO
- 3 DIÁMETRO DE LA CAÑA
- 4 CAÑA
- 5 LONGITUD A
- 6 PALETON
- 7 PERFIL MACHO
- 8 REFERENCIA
- 9 MARCA ORIGINAL
- 10 PERFIL HEMBRA

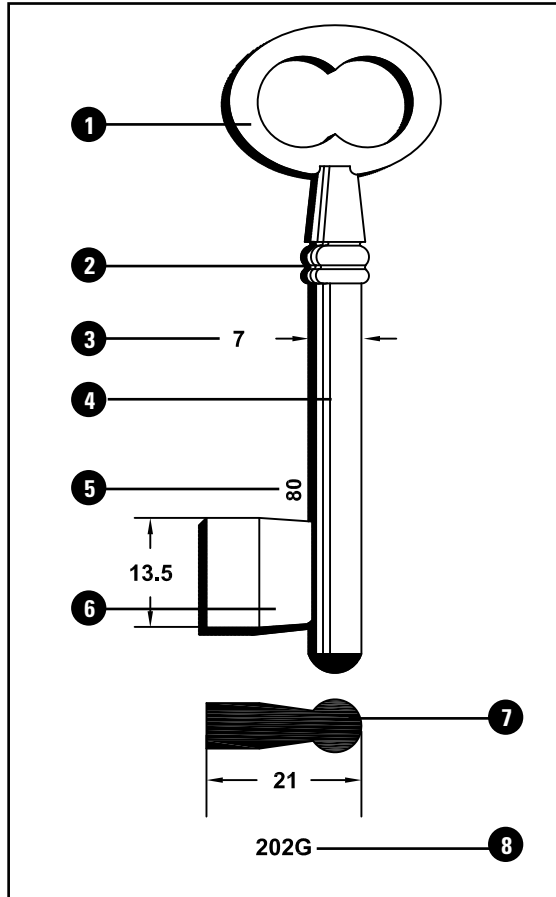

### 9 — FOR: ORENGO®

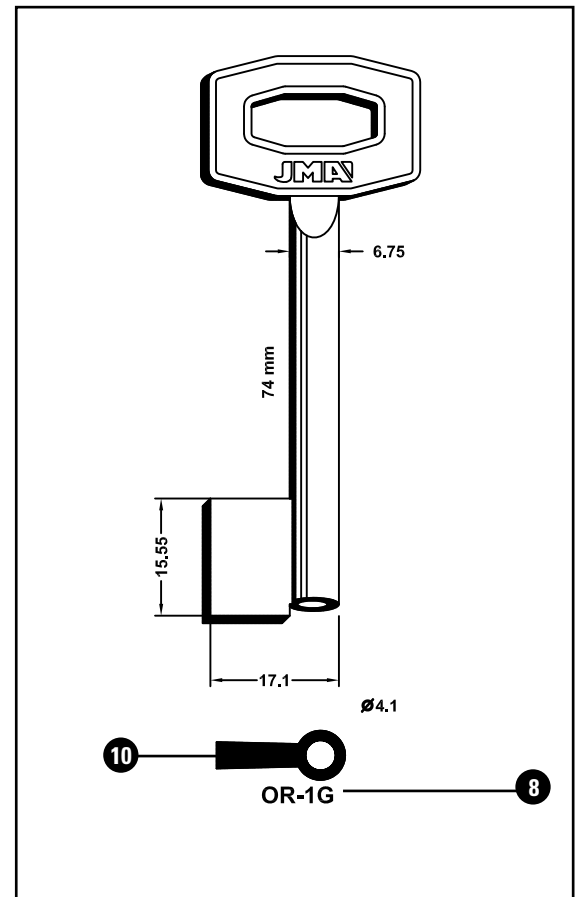

### EUSKERA

- 1 BURUA
- 2 LEPOA
- 3 ZIRIAREN  
DIAMETROA
- 4 ZIRIA
- 5 A LUZERA
- 6 BELARRIA
- 7 PROFIL ARRA
- 8 ERREFERENTZIA
- 9 JATORRIZKO  
MARKA
- 10 PROFIL EMEA

### ENGLISH

- 1 HEAD
- 2 NECK
- 3 SHANK  
DIAMETER
- 4 SHANK
- 5 LENGTH A
- 6 BIT
- 7 PIN BIT PROFILE
- 8 REFERENCE
- 9 ORIGINAL BRAND
- 10 PIPE BIT PROFILE

### FRANÇAIS

- 1 TÊTE
- 2 COU
- 3 DIAMETRE DU  
CANON
- 4 CANON
- 5 LONGUEUR A
- 6 PANNETON
- 7 PROFIL MÂLE
- 8 RÉFÉRENCE
- 9 MARQUE  
ORIGINALE
- 10 PROFIL FEMELLE

### DEUTSCH

- 1 KOPF
- 2 HALS
- 3 HALM-  
DURCHMESSER
- 4 HALM
- 5 LÄNGE A
- 6 BART
- 7 SCHWEIFUNG
- 8 BEZEICHNUNG
- 9 ORIGINAL-  
PRÄGUNG
- 10 GEBOHRT

**ALP.**

**Llave fabricada en alpaca**

Alpakaz egindako giltza  
Key available in nickel silver  
Clé fabriquée en maillechort  
Schlüssel auch in Neusilber lieferbar

**LAT.**

**Llave disponible también en latón**

Giltza, letoizkoa ere eskuragarria  
Key also available in brass  
Clé aussi disponible en laiton  
Schlüssel auch in Messing lieferbar

**COL.**

**Llave disponible también con cabeza de plástico en colores**

Giltza hau koloretako plastikozko buruarekin ere eskuragarria

Key also available with coloured plastic head

Clé aussi disponible avec tête plastifiée en couleurs

Schlüssel auch mit farbigem Plastikkopf lieferbar

**ALU.**

**Llave disponible también en aluminio**

Giltza, aluminioan ere eskuragarria  
Key also available in aluminium  
Clé aussi disponible en aluminium  
Schlüssel auch in Aluminium lieferbar

**ZAM.**

**Llave fabricada solamente en zamak**

Zamakez soilik egindako giltza  
Key only available in zamak  
Clé aussi disponible en zamak  
Schlüssel nur aus Zamak lieferbar



35

**Llave de utilización en candados**

Giltzarrapoetan erabiltzeko giltzak  
Key for padlocks  
Clé pour cadenas  
Schlüssel für Hangschlösser



**Llave de utilización en cerraduras auxiliar**

Sarraila osagarrietan erabiltzeko giltzak  
Key for cam locks  
Clé pour petite serrurie  
Schlüssel für Hebelschlösser



**Llaves para motocicletas**

Motozikleta giltzak  
Key for motorcycles  
Clé pour motocyclettes  
Schlüssel für Motorräder



**Llave para tapón de gasolina**

Gasolina-tapoietarako giltza  
Key for fuel cap  
Clé pour bouchon d'essence  
Schlüssel für Tankdeckel



**Llave para camión**

Kamioiko giltza  
Key for lorries  
Clé pour camion  
Schlüssel für Lastkraftwagen



**Alarma**

Alarma  
Alarm  
Alarme  
Alarm



**Llaves gorja con acabado en color natural**

Gorja giltzak berezko kolorezko akaberarekin  
Bit key blank with natural colour finishing  
Clé à gorges avec finition en couleur naturel  
Chubbsschlüssel in naturfarben Ausführung



**Llaves gorja con acabado en negro antiguo**

Gorja giltza, beltz zaharkitu akaberarekin  
Bit key blank with old black finishing  
Clé à gorges avec finition en vieux noir  
Chubbsschlüssel in altschwarzer Ausführung

## NACIONALIDAD - HERRIALDEA - NATIONALITY - NACIONALITÉ - NATIONALITÄT

AUSTRIA  
AUSTRALIA  
BELGIUM  
BRAZIL  
CANADA  
SWITZERLAND  
GERMANY  
DENMARK

**A**  
**AUS**  
**B**  
**BR**  
**CDN**  
**CH**  
**D**  
**DK**

ALGERIA  
SPAIN  
ESLOVAKIA  
EGYPT  
FRANCE  
GREAT BRITAIN  
GREECE  
HUNGARY

**DZ**  
**E**  
**ES**  
**ET**  
**F**  
**GB**  
**GR**  
**H**

HONG KONG  
CROATIA  
ITALY  
ISRAEL  
INDIA  
EIRE  
JAPAN  
KOREA

**HK**  
**HR**  
**I**  
**IL**  
**IND**  
**IRL**  
**J**  
**K**

# SÍMBOLOS

## SYMBOLS

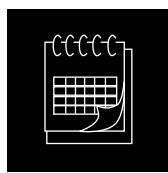

### **Calendario**

Egutegia  
Calendar  
Calendrier  
Kalender

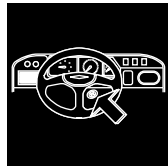

### **Contacto auto**

Autoko kontaktua  
Engine ignition  
Contact auto  
Zündschloss Pkw

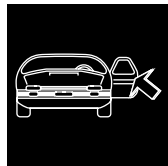

### **Puerta**

Atea  
Door lock  
Portière  
Türe

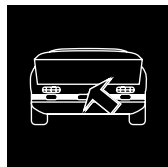

### **Maletero/Puerta trasera**

Maletategia/Atzeko atea  
Boot/Hatchback  
Coffre/Portière postérieure  
Kofferraum/Hecktür



### **Tapón de gasolina**

Gasolina-tapoia  
Petrol cap  
Bouchon réservoir  
Benzintankverschluss

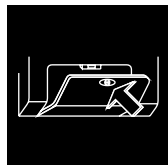

### **Guantera**

Eskularru-kutxa  
Drawer  
Tiroir  
Schublade

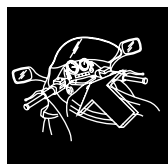

### **Contacto moto**

Moto-kontaktua  
Motorbike ignition  
Contact moto  
Zündschloss Motorrad

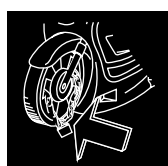

### **Bloqueo moto**

Moto-blokeoa  
Motorbike disc lock  
Bloquage moto  
Bremsenschloss Motorrad

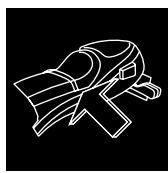

### **Sillin**

Zela  
Cycle seat  
Selle  
Sattel

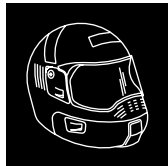

### **Casco**

Kaskoa  
Helmet  
Casque  
Helm



### **Automovil / camioneta**

Automobila / kamioneta  
Car / Pick-up trucks  
Voiture / Camionnette  
Auto / Kleintransporter

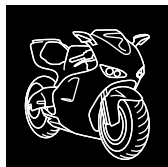

### **Motocicleta**

Motozikleta  
Motorcycle  
Motocyclette  
Motorrad



### **Camión**

Kamioia  
Trucks  
Camion  
Lkw



### **Avión**

Hegazkina  
Aeroplane  
Avion  
Flugzeuge

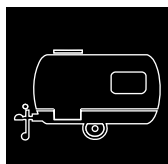

### **Caravana**

Karabana  
Caravans  
Caravane  
Wohnwagen

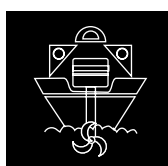

### **Motor marino**

Itsas motorra  
Boat engines  
Moteur de bateau  
Schiffsmotoren

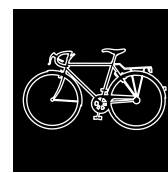

### **Bicicleta**

Bizikleta  
Bicycle  
Bicyclette  
Fahrräder

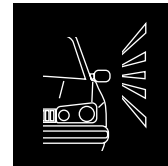

### **Alarma**

Alarma  
Alarm  
Alarme  
Alarm

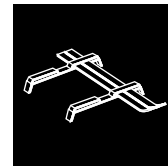

### **Portaesquis**

Eski-euskarria  
Ski holder  
Porte ski  
Skiträger

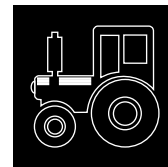

### **Tractor**

Traktorea  
Tractor  
Traktor  
Landmaschinen

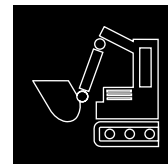

### **Escavadora**

Hondeatzailea  
Earth moving machine  
Machine déplacement de terre  
Baumaschinen



### **Carretilla elevadora**

Orga jasotzailea  
Forklift  
Clark  
Gabelstapler

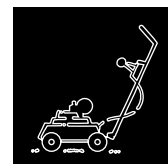

### **Corta cesped**

Belarra mozteko makina  
Lawn-mower  
Tondeuse  
Rasenmäher



### **Alarma - llave**

Alarma - giltza  
Alarm - key  
Alarme - clef  
Alarm - Schlüssel

KUWAIT  
MEXICO  
NORWAY  
THE NETHERLANDS  
PORTUGAL  
PERU  
POLAND  
ARGENTINA

**KW**  
**MEX**  
**N**  
**NL**  
**P**  
**PE**  
**PL**  
**RA**

TAIWAN  
CHILE  
CHEKIA  
RUMANIA  
SWEDEN  
FINLAND  
SLOVENIA  
RUSIA

**RC**  
**RCH**  
**RCZ**  
**RU**  
**S**  
**SF**  
**SLO**  
**RUS**

CHINA  
TUNISIA  
UNITED STATES OF AMERICA  
YUGOSLAVIA  
VENEZUELA  
ZAMBIA

**TJ**  
**TN**  
**USA**  
**YU**  
**YV**  
**Z**



**ÍNDICE**  
AURKIBIDEA  
INDEX  
INDEX  
GESAMTVERZEICHNIS



**SUPLEMENTO-SUPPLEMENT**  
**C11.2021**

**THE KEY TO EXCELLENCE**  
GLOBALLY UNLOCKING MILLIONS OF DOORS DAILY

## ÍNDICE GENERAL

INDIZE OROKORRA • GENERAL INDEX • INDEX GENERALE • GESAMTVERZEICHNIS

REF.	PAG.	REF.	PAG.	REF.	PAG.	REF.	PAG.	REF.	PAG.
101-1G	32	BAB-13/13	3	CI-71P	6	DOM-80	7	GD-1P	10,24
101-2G	32	BAB-20D/2	3	CI-72P	6	DOM-80D	7	GDA-4D	10
716-1G	32	BAO-1	3	CI-73P	6	DOM-B2	8	GDA-5	10
716-2G	32	BAO-1D	3	CI-75P	6	DOM-B6	8	GE-22/1	10
ABU-3D	1	BK-16	4	CI-76P	6	DR-2D	7	GE-22/2	10
ABU-35DP	1,24	BK-16/11	4	CI-77P	6	ELB-2G	33	GE-22/3	10
ABU-70D	1	BK-21/3	4	CI-78P	6	ELB-3G	33	GE-22/4	10
ABU-87P	1,24	BK-21/4	4	CI-79P	6	ELZ-13	8	GE-22/5	10
ABU-88P	1,24	BK-21/5	4	CI-80P	6	ESP-4D	8	GE-22/6	10
ABU-89D	1	BK-21/6	4	CI-81	6	EU-15P	24	GE-22/7	10
ABU-90	1	BK-21/8	4	CI-81P	6	EU-16DP	24	GE-22/8	10
ABU-91	1	BK-21/10	4	CI-82P	6	EU-17	8	GE-22/11	10
ABU-92	1	BK-21/16	4	CI-83P	6	EUB-2D	8	GE-22/12	10
ABU-92D	1	BK-22	3	CI-84P	6	EUP-4D	8	GE-22/13	10
ABU-93	2	BK-23	3	CI-DL WINDCOLOR	6	EUS-1G	33	GE-22/15	10
ABU-94D	1	BK-26/125	4	CI-GDL	6	EV-14	9	GE-22/16	10
ABU-95	2	BK-26/135	4	CIT-1C1	28	EV-15D	8	GE-22/17	10
ABU-96	2	BK-26/145	4	CLA-1G	32	EV-28D/0	9	GE-22/18	10
ABU-99D/1	1	BK-26/235	4	CLA-2G	33	EV-29D/0	9	GE-22/19	10
ABU-99D/2	1	BK-26/237	4	CLA-4G	33	EV-30	9	GEA-9/1	10
ABU-99D/3	1	BK-26/245	4	CNP-2D	5	EVE-2	8	GEA-9/3	10
ABU-100	1	BK-26/246	4	COR-1D WINDCOLOR	6	EZ-11G	34	GEA-9/4	10
ABU-102	2	BMB-3	4	COR-230	6	EZ-DS15R WIND-COLOR	9	GEA-9/6	10
ABU-101P	2	BMB-4	4	COR-231	7	FA-9G	34	GEA-9/7	10
AGA-55D	2	BMB-5	4	COR-232D	7	FA-10G	34	GEA-9/9	10
AGA-57	2	BRI-1	32	COR-61	6	FA-11G	34	GEA-9/10	10
AGB-6	2	BRI-19 WINDCOLOR	4	COR-70	6	FAC-25	9	GEA-9/11	10
AGB-7	2	BRI-2	32	CRF-1D	5	FAIN-11 WINDCOLOR	9	GEA-9/13	10
AMG-11	2	BRI-3	32	CVL-5D WINDCOLOR	7	FAV-3	9	GEA-9/14	10
AMG-12D	2	BRN-1D	4	CVL-5I WINDCOLOR	7	FER-3D	9	GEA-9D/2	10
AS-30D	3	BRN-2D	4	DAC-4DP	24	FER-2D	9	GEA-9D/5	10
ASC-1D	3	BUR-35D	5	DAC-6DC1	24	FER-3D	9	GEA-9D/7	10
ATL-1	3	BUR-36	5	DAC-6DP	24	FER-4D	9	GEA-9D/8	10
AX-5DP1	3,24	BUR-36D	5	DAC-7DC1	24	FI-16C3	28	GER-2G	34
AX-6	3	BUR-37D	5	DAT-15P4	27	FF-10GD	9	GER-3G	35
AZ-37D WINDCOLOR	3	BUR-38	4	DBX-1D	7	FIC-400	34	GER-4G	35
BAB-13/1	3	BUR-39	5	DEB-1	33	FLT-1	10	GER-5G	35
BAB-13/2	3	BUR-39D	5	DEB-3	33	FLT-1D	10	GEV-3D	10
BAB-13/3	3	BUR-40D	5	DEK-16	7	FO-24C3	25	GIV-1P	25
BAB-13/4	3	BUR-41	5	DEK-17	7	FO-24C8	25	GIV-2DP	25
BAB-13/5	3	BUR-42D	5	DEN-1	33	FO-24C9	25	GOD-3	10
BAB-13/6	3	BUR-43	5	DLT-1D	7	FO-43D	24	GOD-4	10
BAB-13/7	3	CAY-1D WINDCOLOR	5	DOM-75	7	FTH-30	9	GUA-4	11
BAB-13/8	3	CE-91	6	DOM-76D	7	FV-3	9	GUA-4D	11
BAB-13/9	3	CE-136D/1	6	DOM-77D	8	GARD-2G	34	GUA-5	11
BAB-13/10	3	CE-136D/2	6	DOM-78D	7	GD-1DP	10,24	GUA-5D	11
BAB-13/11	3	CE-136D/4	6	DOM-79D	7				
BAB-13/12	3	CE-136D/5	6						
		CI-48P	6						



## ÍNDICE GENERAL

INDIZE OROKORRA • GENERAL INDEX • INDEX GENERALE • GESAMTVERZEICHNIS

REF.	PAG.	REF.	PAG.	REF.	PAG.	REF.	PAG.	REF.	PAG.
GUS-1	11	KUB-1D	26	NE-60C3	27	TE-8I WINDCOLOR	18	U-5D WINDCOLOR	21
GTV-12	11	KUB-2D	26	NEF-3	15	TE-T60 WINDCOLOR	18	U-5GD	21
HAF-6	11	KWI-1K	13	NEF-4	15	TE-T80EH	18	U-5I WINDCOLOR	21
HEK-4D	11	LAP-3	36	NOR-1	15	TIT-21	18	U-6D WINDCOLOR	21
HEK-5	11	LAP-53	13	NOX-1	16	TIT-22	18	UCEM-8D WINDCO- LOR	20
HEK-6	11	LAP-57	13	OJ-20/4	16	TIT-23	18	UCEM-19	20
HF-1D	11	LAP-71	13	OJ-21D	16	TIT-24	19	UCEM-20D	20
HGO-1	11	LAP-93	13	OMC-7	16	TIT-25	19	UCEM-21	20
HKO-1D	11	LAP-98	13	OP-11C3	25	TIT-26	19	UCEM-22D	21
HGO-2D	11	LAP-100	36	PFA-23D	16	TIT-27	18	VA-1T	37
HOB-1G/36	35	LB-2MD	13	PFA-24	16	TOK-82	19	VA-2T	37
HOK-1D	11	LB-5D	13	PFA-24D	16	TOK-83	19	VA-3T	37
HOK-2D	11	LB-6D	13	PFA-25	16	TOK-83D	19	VA-5T	37
HU-4C1	25	LF-47	14	PFA-25D	16	TOK-84D	19	VA-8D WINDCOLOR	21
HU-3D	11	LF-50D	14	PFA-26D	16	TOK-85D	19	VA-61C3	28
HU-HCAP	25	LF-51	14	PL-1	21	TOK-86D	19	VA-75D WINDCOLOR	21
HY-10	25	LIN-21D WINDCOLOR	13	PL-1D	21	TOK-87D	19	VA-91	21
HY-11P4C1	25	LIN-25D WINDCOLOR	13	PR-21	16	TOK-88D	19	VA-400	37
HY-18P1C1	25	LIN-26D	13	PR-22	17	TOU-1D	19	VA-700	37
HY-19DP5	26	MAF-1	36	PTN-3D	16	TOV-8D	19	VO-HVP1	25
HY-19P5	26	MAU-1	14	PTN-12G	37	TOYO-9P2	27	VO-KP	25
HY-20P	26	MAU-2	14	RE-5	17	TOYO-15DP	27	WIL-23	21
IF-10D	12	MAU-3D	14	RE-6	17	TOYO-15P10	27	WIL-66D	22
IF-7	12	MAU-4D	14	RE-6D	17	TOYO-40	28	YA-280D	22
IF-8	12	MAU-5D	14	RO-29D WINDCOLOR	17	TOYO-40D	28	YA-281D	22
IF-9	12	MCM-15E8	14	RO-43	17	TOYO-41P	28	YA-282	22
IS-21D	12	MCM-45	14	RO-44D	17	TRI-9DSP	20	YA-283D	22
IS-3D WINDCOLOR	12	MEC-6	14	RO-45	17	TRI-17	20	YA-286D	22
ISU-3DP1	26	MED-1D	15	RO-46	17	TRL-3	19,28	YA-300D	22
ISU-5	26	MEG-1D	15	ROD-1	17	TRL-3D	19,28	YA-306	22
ITO-3D	12	MERI-1P1	26	ROD-1D	17	TRL-4P	28	YAMA-25P	28
IV-3D	12	MERI-1DP1	26	RSS-3	17	TRL-5P	19,28	YAMA-32DP	28
JP-1	35	MERI-2DP	26	RSS-3D	17	TRL-6	20	YAMA-33P1	28
JP-2	35	MH-1	15	RU-1	17	TRL-6D	20	YAMA-34	29
JP-3	35	MH-2D	15	RU-1D WINDCOLOR	17	TRP-2	28	YAMA-34D	29
JP-4	35	MIT-8DP2	27	SA-5D	18	TV-34	20	YAR-4D	22
JP-5	36	MLM-8	15	SEA-2	18	TV-35	20	YET-18	22
JP-6	36	MLM-9	15	SEC-4DP	18	TV-36	20	YET-18D	22
KA-7 WINDCOLOR	12	MOI-4G	36	SEL-1	37	TV-37	20	YET-19D	22
KAE-15D	12	MOI-5G	36	STN-1D	18	TV-38	20	YUH-3D	22
KE-6	12	MQ-2	14	SUZU-8IP	27	TV-39	20	ZA-7DP1	29
KE-7	13	MT-17P1G	36	SUZU-12P	27	TV-40D	20	ZA-9P2	29
KFV-2	13	MT-1P	15	SUZU-21P	27	TV-41	20	ZE-160D	12
KI-11P	26	MT-2D	15	SWL-1	18	TX-12	21		
KI-12DP	26	MT-2DP	15	TC-3	18	TX-13D	21		
KI-12P	26	MUE-1	15	TCH-1DP	18	U-15D WINDCOLOR	21		
KM-1P	26	MUE-2	15	TCH-1P	18	U-4GD	21		

FOR	PAG.
101®	32
716®	32
ABLOY®	1
ABUS®	1,2,4,6,16,24
AGA®	2
AGB®	2
AKS®	25
AMAN®	8
AMIG®	2
APRILIA®	29
ASEC®	3
ASSA®	3
ATLAS®	3
AXA®	3,7,24
AZBE®	3
BAB®	3
BAODELI®	3
BASI®	19
BEFA®	22
BETA®	29
BIFFAR®	19,22
BKS®	3,4
BMB®	4
BMV®	29
BODA®	6
BRABANTIA®	8
BRICARD®	4,13,32
BRISANT®	4
BUFFO®	1,3,24
BURG®	4,5
BURG WACHTER®	5
BWS®	7
CAIB®	16
CANADA POST®	5
CARL F®	5
CASI®	25
CAYS®	5
CEM®	14
CES®	6
CIBOX®	4
CISA®	1,2,6
CITROEN®	28
CLASS®	32,33
CORBIN®	6,7,8
CORONA®	12
CVL®	7
DACIA®	24
DAEWOO®	27
DEBEURAIN-ND®	33
DEKABA®	7,14
DELTA®	7
DENY®	33
DIERRE®	7
DIFA®	17
DINBOX®	7
DOM®	7,8,15
DONNER®	13
ELBOR®	33
ELCA®	8,9
ELEDIS®	8
ELZETT®	8
ESAFE®	18,21
ESP®	8
ET. POWER®	18
EURO BOX®	8
EURO LOCKS®	8,14,17,24

FOR	PAG.
EURO-PROFIL®	8
EUROSPEC®	21,33
EVERGOOD®	8
EVVA®	8,9
EZCURRA®	9,18,34
FAC®	9
FAINER®	9
FAS®	34
FAVOUR®	9
FCV®	9
FEDERAL®	4
FERONERIA®	9
FF®	9
FICHET®	13, 19,34
FINA®	16
FKS®	8,14,19
FLOK®	21
FORD®	24
FORT®	12
FTH®	9,18
FULTON HITCH®	10
G.M.®	27
GAD®	10,24
GARDIAN®	34
GE GE®	10
GERA®	10
GERDA®	6,8,10
GERION®	34, 35
GEVY®	10,15
GIVI®	25
GODREJ®	10
GTV®	11
GUARD®	11
GUARDIAN®	34
GUSHENG®	11
HÄFELE®	11
HAHN & KOLB®	11
HASLER®	18
HEKNA®	11
HERACLES®	18
HFM®	11
HOBBY®	24
HOBES®	35
HOPPE®	4
HOK®	11,15
HUDSON®	11
HUF®	24,25
HUGO®	11
HYMER®	24
HYUNDAI®	25,26
IBFM®	15
IFAM®	12
IKON®	12
ILARGI®	5
ISEO®	12
ISEO SILVER®	12
ISUZU®	26
ITO®	12
IVANA®	12
JOLI SAFE®	20
JORE®	21
JPM®	35,36
KABA®	12
KALE®	12
KAWASAKI®	27
KESO®	12,13

FOR	PAG.
KFV®	9,13
KIA®	25,26
KIND®	4
KTM®	26
KUBOTA®	26
KWIKSET®	13
LASBOLAGET®	12
LAPERCHE®	13,36
LEHMANN®	15
LEXUS®	28
LINCE®	13
LOB®	13,22
LOWE & FLETCHER®	8,14
MAFOR®	36
MAHINDRA RENAULT®	26
MARQUES®	14
MARS®	8
MASTER®	13
MAUER®	7,14
MAZDA®	28
MCM®	14
MECO®	14
MEDOS®	15
MEGA®	11,15
MERIT LINDE®	26
METALCASTELLI®	11
MHA®	15
MINIBUS®	26,27
MLM®	15
MOIA®	36
MOREAUX®	7
MOTTURA®	10,15,36
MUEL®	15
NEIMAN®	25,27
NEMEF®	6,15
NISSAN®	27
NOORI®	15
NOXXA®	16
OJMAR®	16
OMEC®	16
OMR®	36
OPEL-CHEVROLET®	25
ORDO®	15
PETCO®	13
PFÄFFENHAIN®	16
POTENT®	16,37
PREFER®	16,17
PUCH®	28
RAUCO®	11
REGENT®	11
REMOCON®	20
RENZ®	17
RODES®	17
RONIS®	17
ROTO®	4
RUKO®	17
RUSSIA®	17
SAMSONITE®	18
SANTOS®	16
SCHRITT®	12
SCHURING®	19
SCUDO 5000®	2
SEA®	18
SECUREMME®	18
SELECT®	37
SHAW WALKER®	18

FOR	PAG.
SHERLOCK®	10
SIB®	5
SIL®	9,21
STANDERS®	18
STARRY LOCK®	18
STHALEX®	18
STORWALL®	18
STUV®	7,15,17
STS®	8,18
STV®	15
SUZUKI®	27
TECHNO®	18
TECON®	18
TESA®	18
THIRARD®	9
TITAN®	18,19,20
TOK WINKHAUS®	19
TOKAJ® - RIKAI®	27,28
THIRARD®	9
THOMAS LAIDLAW®	18
TOPLOCK®	15,18
TOUCH®	19
TOVER®	19
TOYOTA®	27,28
TRELOCK®	19,20,28
TRI-CIRCLE®	20
TRIO-VING®	20
TRIUMPH MOTORCY- CLE®	28
TROMER®	19
TRW-SIPEA®	28
TRYBA®	9
TSC®	9
UBE®	25
UCEM®	18,20,21
ULTION®	4
ULTRA®	14
UNION®	14
UNIVERSAL®	21
VACHETTE®	13,21,28,37
VALEO®	28
VARIOS®	21
VBH®	9
VESPA®	28
VF (VEROFER)®	9
VIDMAR®	18
VOLKSWAGEN®	25
WEDO®	8
WILKA®	21,22
WIGRO®	21
WINKHAUS®	19
WITTE®	25
WSS®	11,17
WÜRTH®	9,11
YALE®	28
YAMAHA®	28,29
YARDENI®	22
YEMAR®	18
YETI®	22
YUN HUAN®	22
ZADI®	29
ZEISS IKON®	12

# **LLAVES PLANAS PARA CERRADURAS DE CILINDRO**

*SARRAILA ZILINDRIKOTARAKO GILTZA ZAPALAK*

*CYLINDER KEYS*

*CLÉS POUR CYLINDRES*

*ZYLINDERSCHIÜSSEL*



**SUPLEMENTO-SUPPLEMENT**  
**C11.2021**

**THE KEY TO EXCELLENCE**  
GLOBALLY UNLOCKING MILLIONS OF DOORS DAILY



FOR: ABLOY®

FOR: ABUS®

FOR:  
ABLOY® (FI)  
ABUS® (DE)

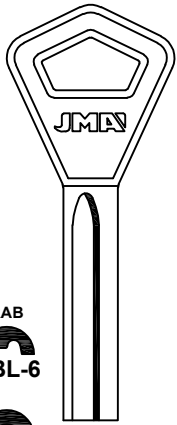

RAB  
ABL-6

ABL-4

C  
ABL-3

LAT.  
ABL-3D  
NEW

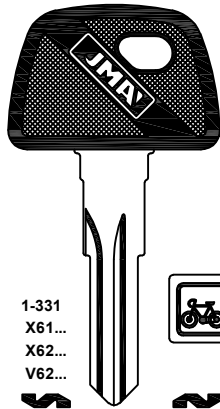

1-331  
X61...  
X62...  
V62...

ABU-35.P

1-331  
V61...  
V62...  
ABU-36.P



ABU-35D.P  
NEW

FOR: BUFFO®

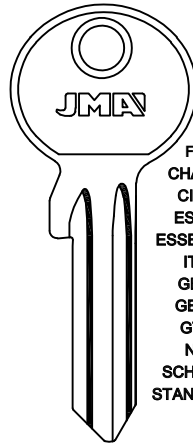

FOR:  
CHAVO®  
CISA®  
ESCO®  
ESSENDIA®  
ITO®  
GEFI®  
GETE®  
GTV®  
NB®  
SCHUCO®  
STANDARD®

ABU-41

ABU-41D

ABU-68

ABU-92  
NEW

ABU-92D  
NEW

ABU-99D/1  
NEW

ABU-99D/2  
NEW

ABU-99D/3  
NEW

FOR: ABUS®

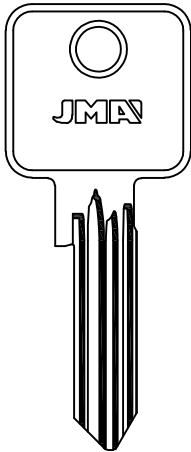

ABU-48

\* LAT.

FOR: CISA®

K1D  
ABU-70

ABU-77

ABU-80

ABU-83

X4S  
\* ABU-85

C83  
ABU-100  
NEW

ABU-58D

K1S  
ABU-70D  
NEW

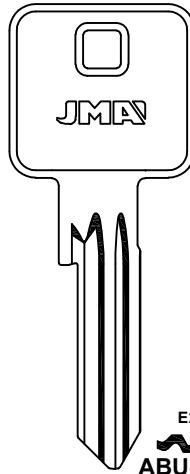

E20  
ABU-86D

E60  
ABU-94D  
NEW

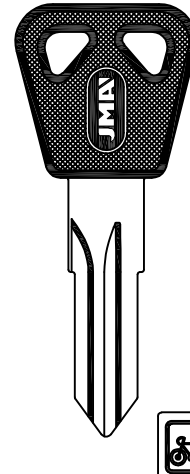

NW52  
ABU-87.P  
NEW



FOR: ABUS®

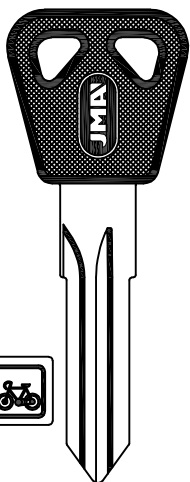

NW72  
ABU-88.P  
NEW

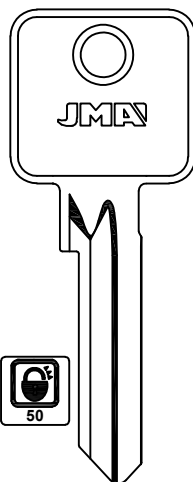

SERIE 90/50  
ABU-89D  
NEW

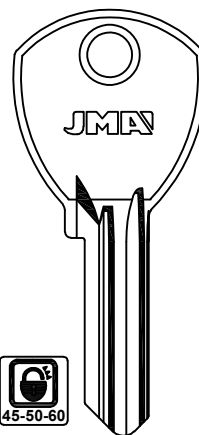

SERIE 64TI  
ABU-90  
NEW

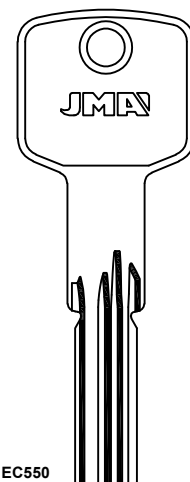

LAT.

EC550  
8.2  
2.8  
ABU-91  
NEW



FOR:

ABUS® (DE)

AGA® (ES)

AGB® (IT)

AMIG® (ES)

FOR: ABUS®

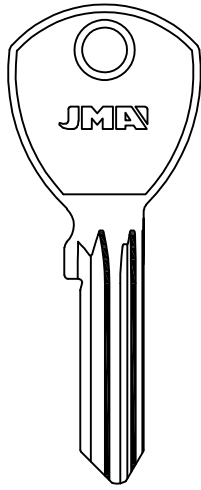

ABU-93  
NEW

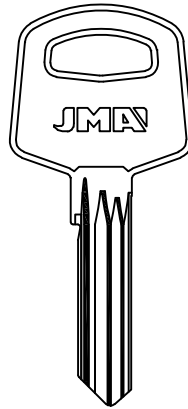

ABU-95  
NEW

LAT.

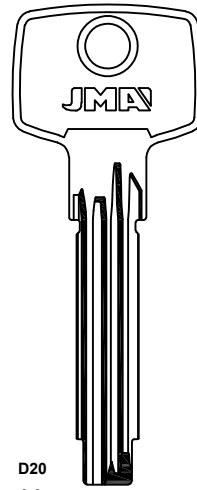

D20  
8.2  
2.8  
ABU-96  
NEW

LAT.

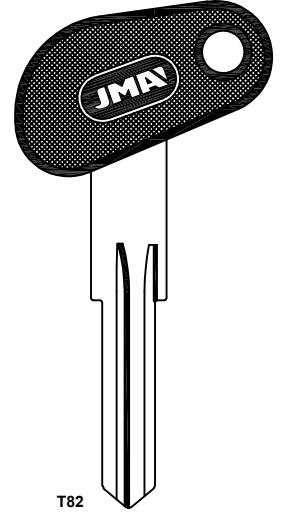

T82  
ABU-101.P  
NEW

FOR: CISA®

FOR: ABUS®

FOR: AGA®

FOR: AGB®

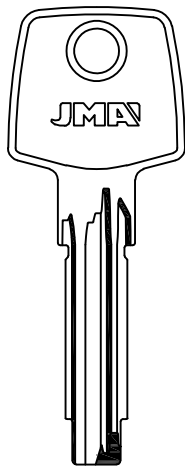

EC-S  
8.2  
2.8  
ABU-102

LAT.

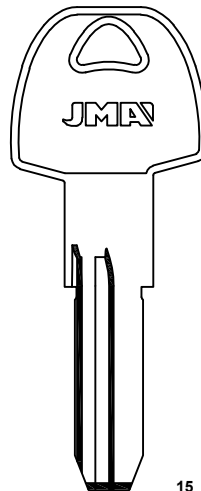

15  
9  
2.3  
AGA-55D  
NEW

ALP.

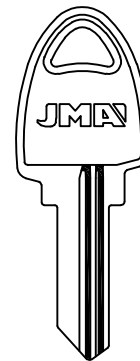

15I  
AGA-57  
NEW

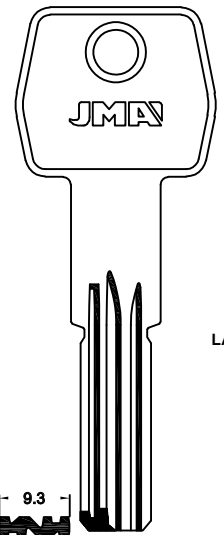

9.3  
2.8  
AGB-6  
NEW

LAT.

SCUDO 5000

FOR: AGB®

FOR: AMIG®

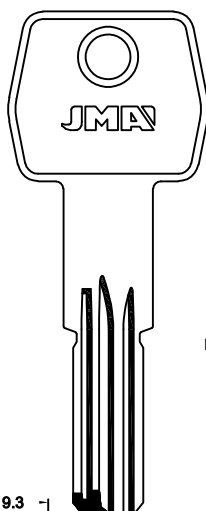

9.3  
2.8  
AGB-7  
NEW

LAT.

SCUDO 5000

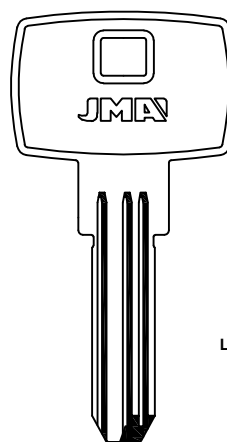

18080  
8.3  
2.5  
AMG-11  
NEW

LAT.

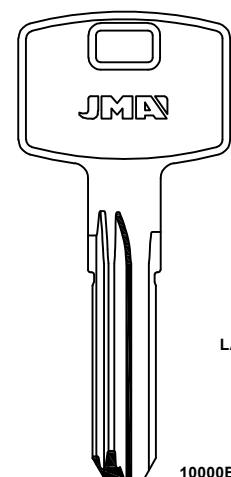

10000E / 10580  
8.4  
2.8  
AMG-12D  
NEW

LAT.

JMA®



ATENCIÓN: Concerniente a las marcas y denominaciones comerciales ver nota en índice.  
ATTENTION: Concerning the marks and commercial denominations see note in index.  
ATTENTION: Concernant les marques et dénominations commerciales voir la note dans l'index.  
ACHTUNG: Beziehen auf die marke und handelsname sehen sie die notiz im index.

FOR: ASEC®

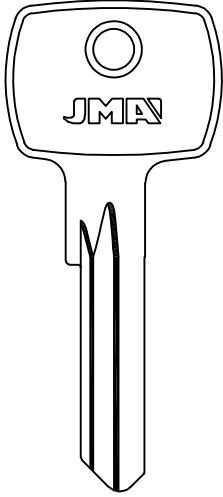

ASC-1D  
NEW

FOR: ASSA®

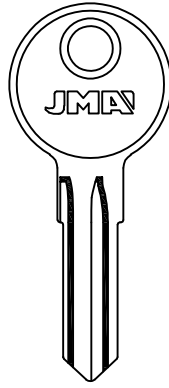

AS-30D  
NEW

FOR: ATLAS®

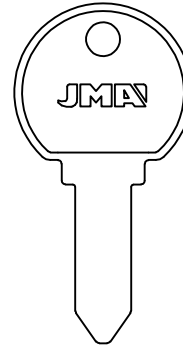

LAT.

AL  
ATL-1  
NEW

FOR:

- ASEC® (GB)
- ASSA® (SE)
- ATLAS® (US)
- AXA® (SE)
- AZBE® (ES)
- BAB® (DE)
- BAODELI® (CN)
- BKS® (DE)

FOR: AXA®

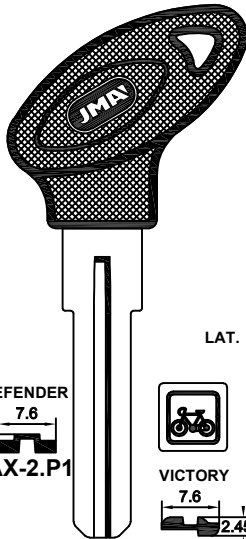

LAT.

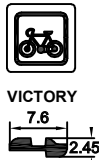
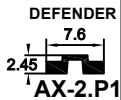

FOR: BUFFO®

NEW

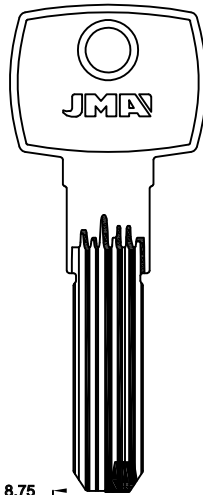

LAT.

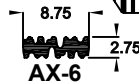

NEW

FOR: AZBE®

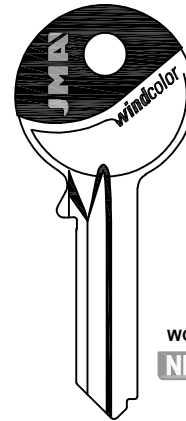

WCOLOR  
NEW

AZ-37D

FOR: BAB®

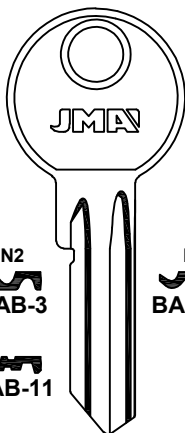

N2  
BAB-3

N1  
BAB-3D

BAB-11

BAB-19

BAB-12D

BAB-20D/2  
NEW

206  
BAB-13/1  
NEW

209  
BAB-13/2  
NEW

307  
BAB-13/3  
NEW

210  
BAB-13/4  
NEW

406  
BAB-13/5  
NEW

407  
BAB-13/6  
NEW

BAB-13/7  
NEW

510  
BAB-13/8  
NEW

BAB-13/9  
NEW

BAB-13/10  
NEW

BAB-13/11  
NEW

310  
BAB-13/12  
NEW

BAB-13/13  
NEW

FOR: BAODELI®

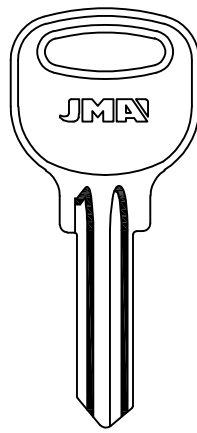

BAO-1  
NEW

BAO-1D  
NEW

FOR: BKS®

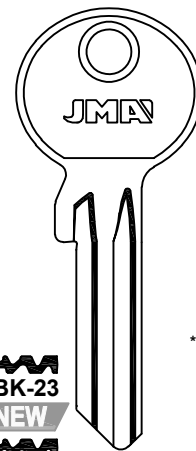

\* ALU.

BK-23  
NEW

BK-22  
NEW

BK-6I 38

NA  
\* BK-6D

JMA®

Copyright by Alejandro Altuna S.L.U. 2021



ATENCIÓN: Concerniente a las marcas y denominaciones comerciales ver nota en índice.  
 ATTENTION: Concerning the marks and commercial denominations see note in index.  
 ATTENTION: Concernant les marques et dénominations commerciales voir la note dans l'index.  
 ACHTUNG: Beziehen auf die marke und handelsname sehen sie die notiz im index.

**FOR:**

BKS ® (DE)

BMB ® (DE)

BRICARD ® (FR)

BRISANT ® (GB)

BURG ® (DE)

**FOR: BKS ®**

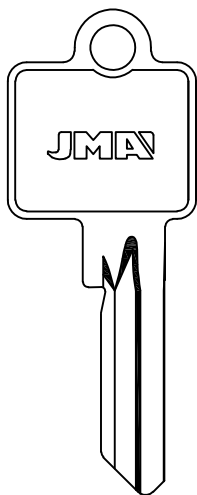

NA  
BK-7D

- |                    |                     |                      |
|--------------------|---------------------|----------------------|
| BK-21/1            | <b>NEW</b> BK-21/8  | <b>NEW</b> BK-26/125 |
| BK-21/2            | BK-21/9             | <b>NEW</b> BK-26/135 |
| <b>NEW</b> BK-21/3 | <b>NEW</b> BK-21/10 | <b>NEW</b> BK-26/145 |
| <b>NEW</b> BK-21/4 | BK-21/14            | <b>NEW</b> BK-26/235 |
| <b>NEW</b> BK-21/5 | <b>NEW</b> BK-21/16 | <b>NEW</b> BK-26/237 |
| <b>NEW</b> BK-21/6 | BK-21/17            | <b>NEW</b> BK-26/245 |
| BK-21/7            | BK-21/19            | <b>NEW</b> BK-26/246 |

**FOR: BKS ®**

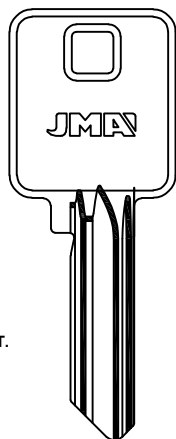

\* LAT.

BK-16  
**NEW**

- |           |            |            |
|-----------|------------|------------|
| * BK-16/7 | * BK-16/16 | BK-16/30   |
| * BK-16/5 | * BK-16/15 | * BK-16/23 |
| * BK-16/4 | * BK-16/14 | * BK-16/21 |
| * BK-16/3 | * BK-16/13 | * BK-16/20 |
| * BK-16/2 | * BK-16/11 | * BK-16/19 |
| * BK-16/1 | * BK-16/10 | * BK-16/18 |
| * BK-16/0 | * BK-16/9  | * BK-16/17 |

SERIE 2000

**FOR: BMB ®**

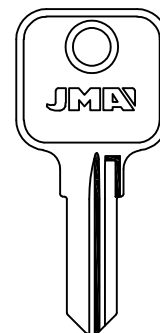

A  
BMB-1

BMB-3 **NEW** BMB-3D

A...201-400

BMB-4 **NEW**

**FOR: BMB ®**

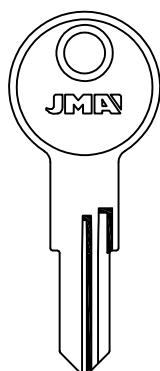

BMB-5  
**NEW**

**FOR: BRICARD ®**

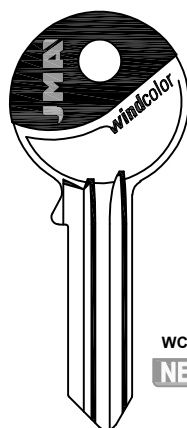

WCOLOR  
**NEW**

BRI-19

FOR: ABUS ®

**FOR: BRISANT ®**

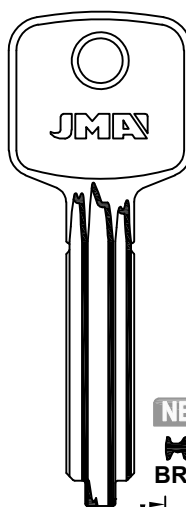

LAT.

**NEW**

BRN-2D

**NEW** 2.95 9  
BRN-1D

FOR: ULTION® - FEDERAL ®

**FOR: BURG ®**

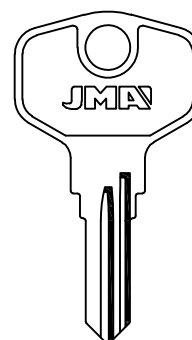

BUR-38 **NEW**

BUR-10 BUR-10D

FOR: CIBOX® -HOPPE® -KIND® -ROTO®





FOR: BURG®

FOR:

BURG® (DE)

BURG  
WACHTER®  
(DE)

CANADA POST®  
(CA)

CARL F® (GB)

CAYS® (ES)

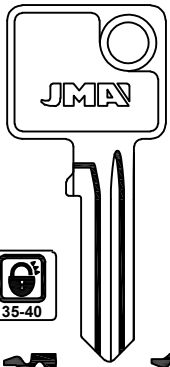

BUR-14

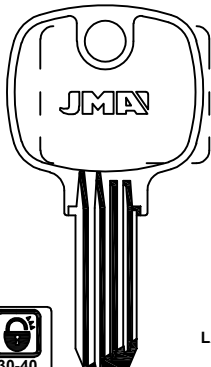

BUR-14D

222 C40

BUR-19D



NEW

BUR-37D

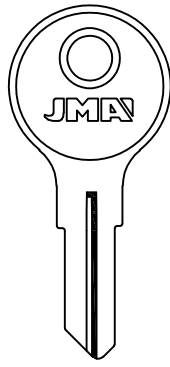

NEW

BUR-35D

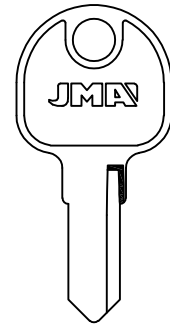

NEW

BUR-36

NEW

BUR-36D

LAT.

NEW

BOCCIA 450  
8.15  
2.85  
BUR-43

BOCCIA 450  
2.85  
BUR-33

FOR: BURG WACHTER®

FOR: BURG®

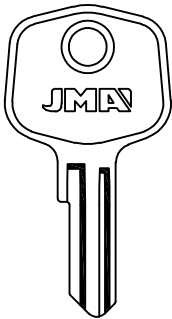

NEW

1-200

BUR-39

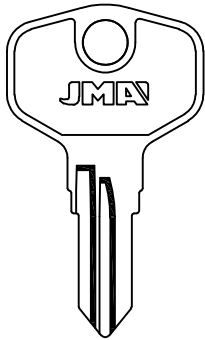

NEW

1-200

BUR-39D

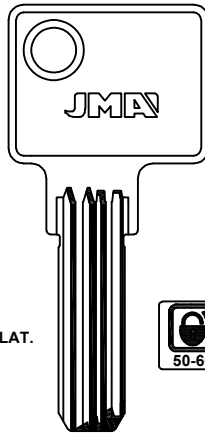

LAT.



NEW

BUR-40D

NEW

BUR-41

BOCCIA 450  
8.8  
2.9

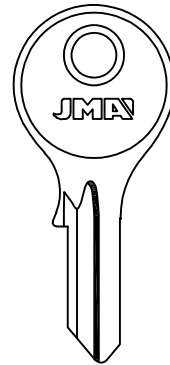

NEW

BUR-42D

FOR: BURG WACHTER®

FOR: CANADA POST®

FOR: CARL F®

FOR: CAYS®

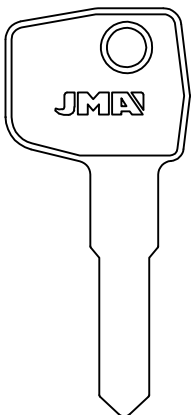

LAT.

CNP-2D

NEW

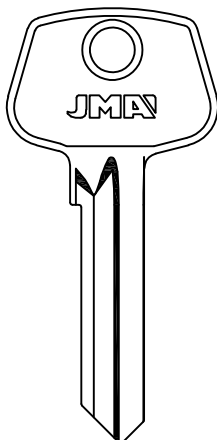

CRF-1D

NEW

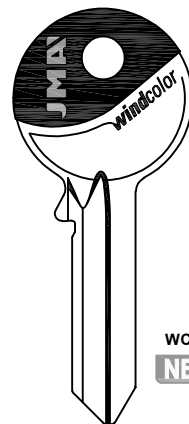

WCOLOR

NEW

CAY-1D

FOR: ILARGI®-SIB®

**JMA**®

Copyright by Alejandro Altuna S.L.U. 2021



ATENCIÓN: Concerniente a las marcas y denominaciones comerciales ver nota en índice.  
ATTENTION: Concerning the marks and commercial denominations see note in index.  
ATTENTION: Concernant les marques et dénominations commerciales voir la note dans l'index.  
ACHTUNG: Beziehen auf die marke und handelsname sehen sie die notiz im index.

**FOR:**  
 CES ® (DE)  
 CISA ® (IT)  
 CORBIN ® (IT)

**FOR: CES ®**

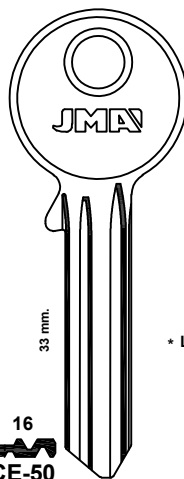
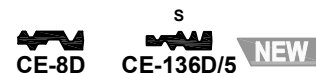
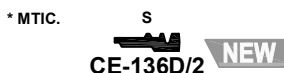
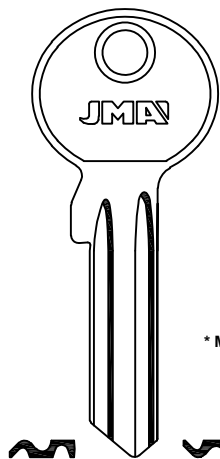

FOR: NEMEF ®

FOR: BODA ®

**FOR: CISA ®**

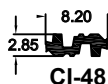
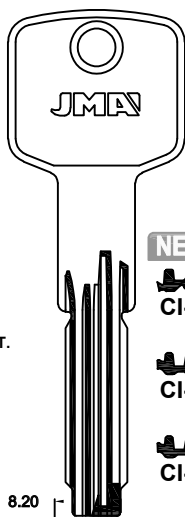

FOR: ABUS ® -GERDA ®

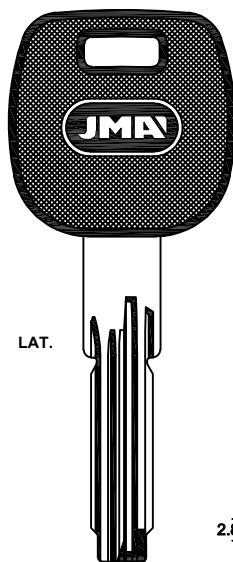

LAT.



FOR: ABUS ®

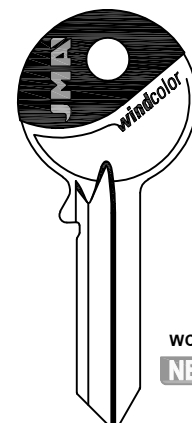

WCOLOR  
**NEW**



**FOR: CISA ®**

**FOR: CORBIN ®**

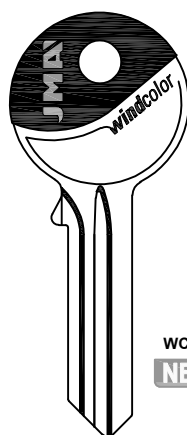
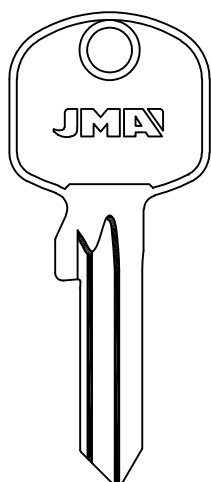

WCOLOR  
**NEW**

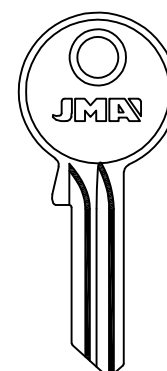
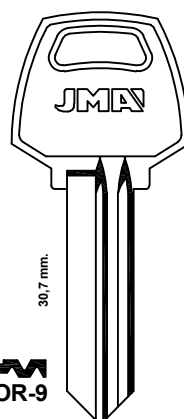

FOR: CORBIN®

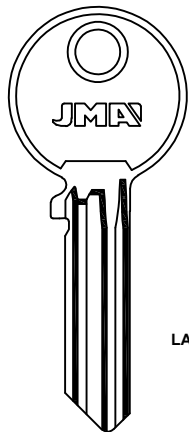

LAT.



COR-231

FOR: BWS®

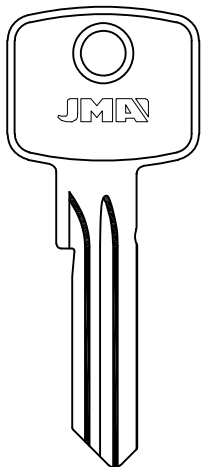

COR-232D

FOR: CVL®

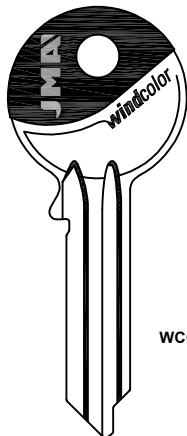

WCOLOR



CVL-5I



CVL-5D

FOR: DEKABA®

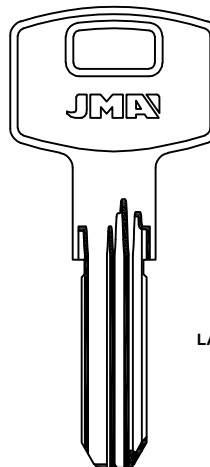

LAT.

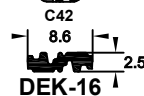

DEK-16

FOR: MAUER®-AXA®

FOR: DEKABA®

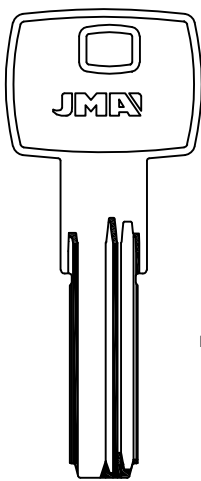

LAT.



DEK-17

FOR: DELTA®

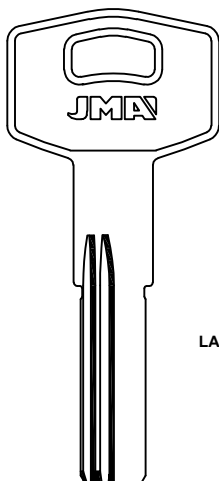

LAT.

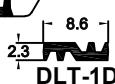

DLT-1D

FOR: DIERRE®

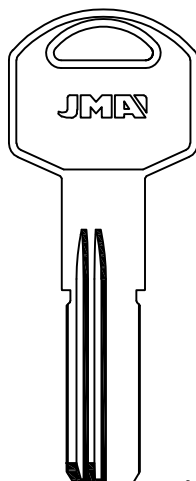

LAT.



DR-2D

FOR: DINBOX®

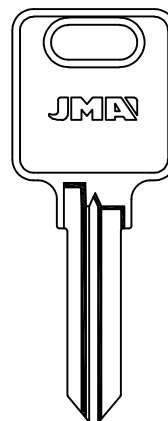

DBX-1D

FOR: DOM®

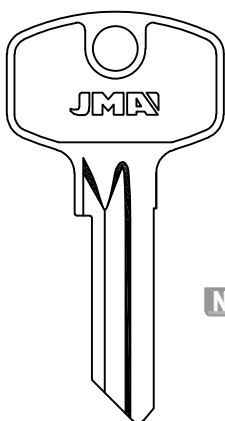

DOM-44D



DOM-45



DOM-46D



PLURA  
NEW DOM-75



NEW DOM-78D



DOM-21D



NEW DOM-79D



HB  
DOM-2D



DOM-80



NEW DOM-80D

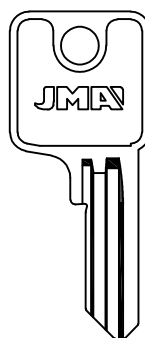

DOM-25D



DOM-49D



NEW DOM-76D

FOR: MOREAUX® -STUV® -CORBIN®

JMA®











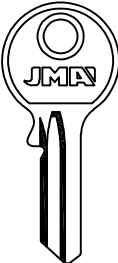
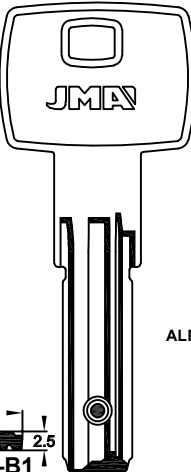
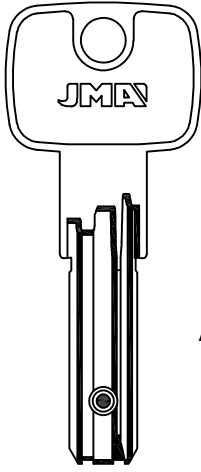
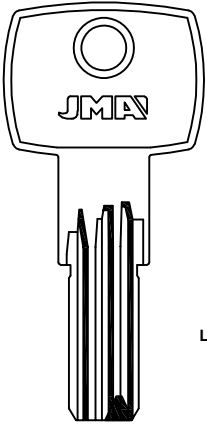

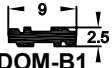



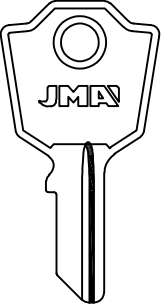
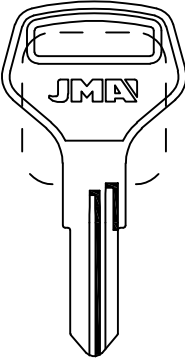
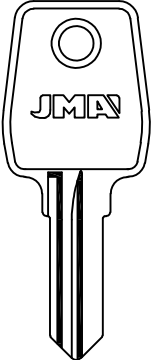





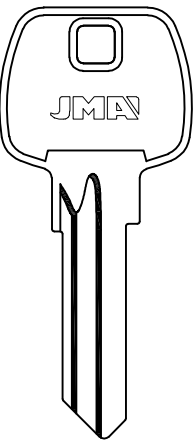
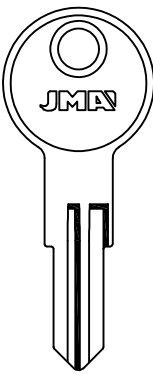
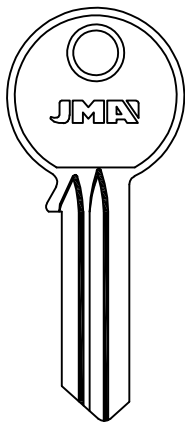

Copyright by Alejandro Altuna S.L.U. 2021

ATENCIÓN: Concerniente a las marcas y denominaciones comerciales ver nota en índice.  
ATTENTION: Concerning the marks and commercial denominations see note in index.  
ATTENTION: Concernant les marques et dénominations commerciales voir la note dans l'index.  
ACHTUNG: Beziehen auf die marke und handelsname sehen sie die notiz im index.

**FOR:**

- DOM ® (DE)
- ELZETT ® (HU)
- ESP ® (US)
- EURO BOX ® (GB)
- EURO LOCKS ® (BE)
- EUROPROFIL ® (PL)
- EVERGOOD ® (TW)
- EWVA ® (AT)

	FOR: DOM ®		FOR: ELZETT ®
		 <p style="text-align: right; margin-right: 10px;">ALP.</p>	 <p style="text-align: right; margin-right: 10px;">ALP.</p>
	 <p style="text-align: right; margin-right: 10px;">LAT.</p>		
	 <p><b>DOM-77D</b> <b>NEW</b></p>	 <p><b>DOM-B1</b></p>  <p><b>DOM-B2</b> <b>NEW</b></p> <p style="text-align: center; font-size: small;">FOR: CORBIN ® -STS ®</p>	 <p><b>DOM-B6</b> <b>NEW</b></p>
			 <p><b>ELZ-13</b> <b>NEW</b></p>
	<b>FOR: ESP ®</b>	<b>FOR: EURO BOX ®</b>	<b>FOR: EURO LOCKS ®</b>
			
	 <p><b>NEW</b> <b>ESP-4D</b></p> <p style="text-align: center; font-size: small;">FOR: FKS ® -ELEDIS ®</p>	 <p><b>EUB-2</b></p>  <p><b>NEW</b> <b>EUB-2D</b></p> <p style="text-align: center; font-size: small;">FOR: BRABANTIA ® -MARS ® -WEDO ®</p>	<p style="text-align: center; font-size: small;">KB 1-500</p>  <p><b>NEW</b> <b>EU-17</b></p>  <p><b>EU-8D</b></p> <p style="text-align: center; font-size: small;">FOR: L&amp;F ®</p>
	<b>FOR: EURO-PROFIL ®</b>	<b>FOR: EVERGOOD ®</b>	<b>FOR: EWVA ®</b>
		 <p style="text-align: right; margin-right: 10px;">* LAT.</p>	
	 <p><b>EUP-4D</b> <b>NEW</b></p> <p style="text-align: center; font-size: small;">FOR: GERDA ®</p>	 <p><b>EVE-2</b></p>  <p><b>EVE-2D</b> <b>NEW</b></p>	<p style="text-align: right; margin-right: 10px;">A</p>  <p><b>EV-1</b></p> <p style="text-align: right; margin-right: 10px;">C</p>  <p><b>EV-2</b></p> <p style="text-align: right; margin-right: 10px;">F</p>  <p><b>EV-3D</b></p> <p style="text-align: right; margin-right: 10px;">E</p>  <p><b>EV-13D</b></p> <p style="text-align: right; margin-right: 10px;"><b>NEW</b></p>  <p><b>EV-15D</b></p> <p style="text-align: right; margin-right: 10px;">M</p>  <p><b>EV-25D</b></p> <p style="text-align: center; font-size: small;">FOR: ELCA ®</p>



FOR: EVVA®

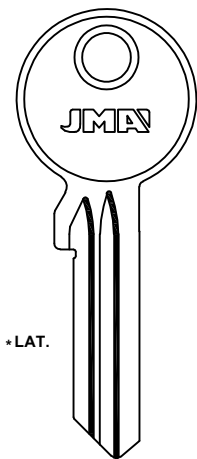

- A EV-6D
- C EV-7D
- F EV-8D
- S EV-9D
- EV-14
- EV-23D
- EV-27D/7
- EV-27D/6
- EV-27D/5
- EV-27D/4
- EV-27D/3
- EV-27D/2
- EV-27D/1
- 5CF EV-30
- EV-29D/0
- EV-28D/0
- EV-27D/10
- EV-27D/9
- EV-27D/8

FOR: ELCA®-TRYBA®-GE GE®-EVVA TSC®-WÜRTH®

FOR: EZCURRA®

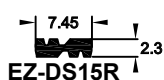
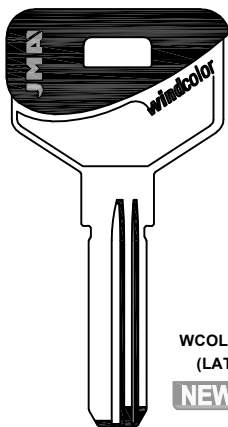

EZ-DS15R

FOR: FAC®

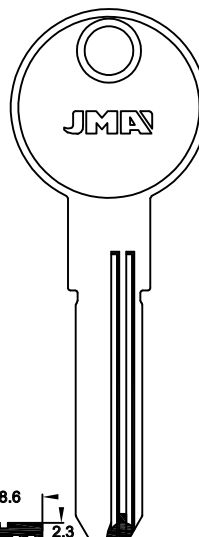

FAC-25

FOR:

- EVVA® (AT)
- EZCURRA® (ES)
- FAC® (ES)
- FAINER® (PT)
- FAVOUR® (DZ)
- FCV® (DE)
- FERONERIA® (RO)
- FF® (IT)
- FTH® (FR)

FOR: FAINER®

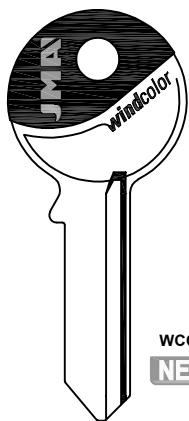

FAIN-11

FOR: SIL®

FOR: FAVOUR®

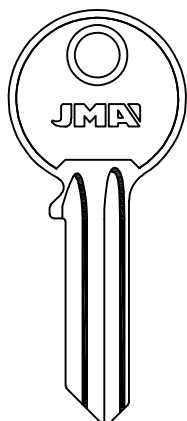

FAV-3

NEW

FAV-3D

NEW

FOR: FCV®

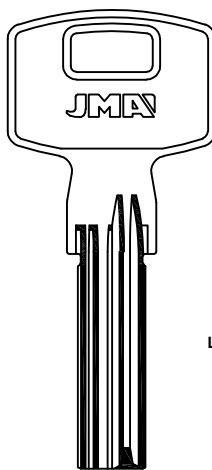

FV-3

FOR: KFV®-VBH®

FOR: FERONERIA®

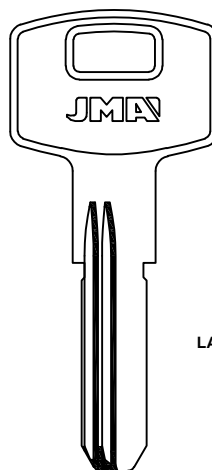

FER-2D

FOR: VF (VEROFER)®

FOR: FERONERIA®

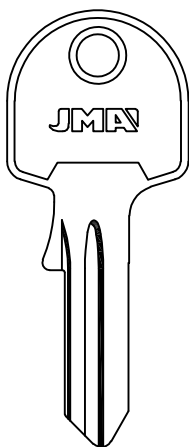

NEW FER-3D

FOR: VF (VEROFER)®

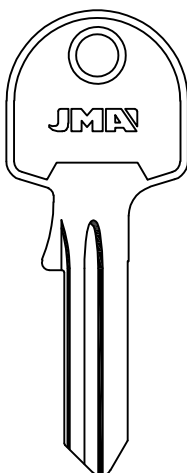

NEW FER-4D

FOR: F.F.®

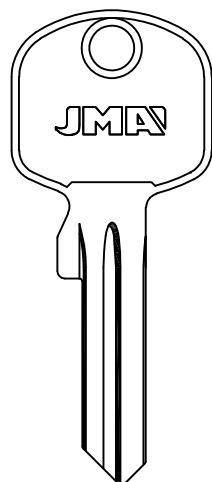

NEW FF-10GD

FOR: FTH®

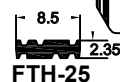
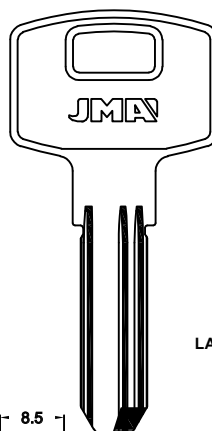

FTH-25

NEW FTH-30

FOR: THIRARD®



FOR:

FOR: FULTON HITCH®

FOR: GE GE®

FULTON HITCH® (GB)  
GE GE® (AT)  
GERA® (DE)  
GERDA® (PL)  
GEVY® (GR)  
GODREJ® (IN)

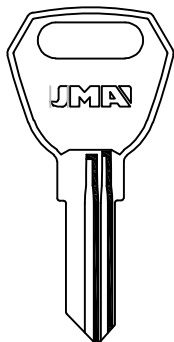

LAT.



NEW



NEW

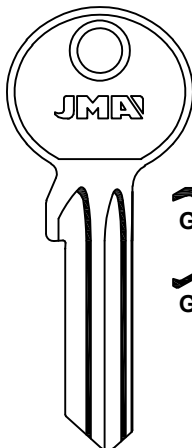

NEW



NEW



NEW



NEW



NEW



NEW

NEW

GE-22/1

NEW

GE-22/2

NEW

GE-22/3

NEW

GE-22/4

NEW

GE-22/5

NEW

GE-22/6

NEW

GE-22/7

NEW

NEW

GE-22/8

FOR: EUROSPEC®

NEW

GE-22/11

NEW

GE-22/12

NEW

GE-22/13

NEW

GE-22/15

NEW

GE-22/16

NEW

GE-22/17

NEW

NEW

GE-22/18

NEW

GE-22/19

NEW

FOR: GAD®

FOR: GERA®

FOR: GERDA®

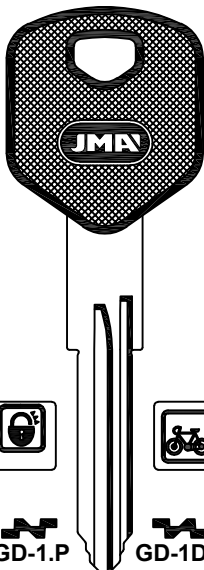

NEW



NEW

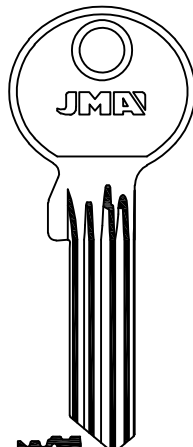

NEW

NEW

NEW

NEW

NEW

NEW

NEW

NEW

NEW

NEW

NEW

NEW

NEW

NEW

NEW

NEW

NEW

NEW

NEW

NEW

NEW

NEW

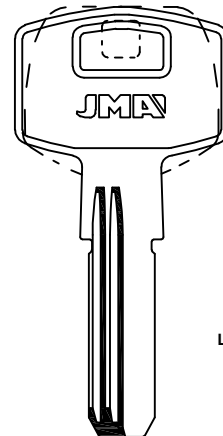

LAT.

NEW

FOR: GERDA®

FOR: GEVY®

FOR: GODREJ®

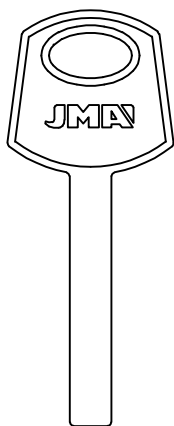

NEW

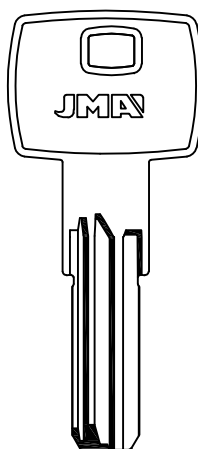

LAT.

NEW

NEW

FOR: MOTTURA®

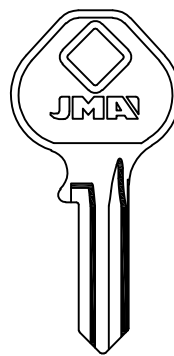

NEW

GOD-3

FOR: SHERLOCK®

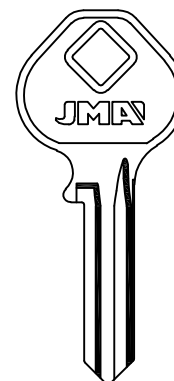

NEW

GOD-4

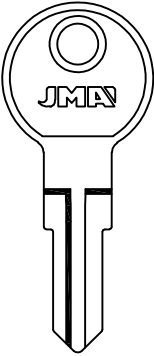
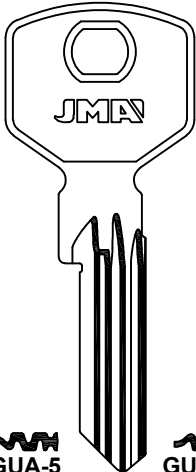
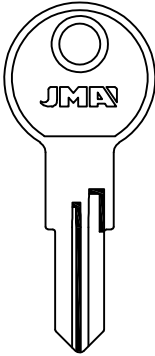
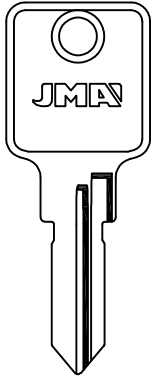
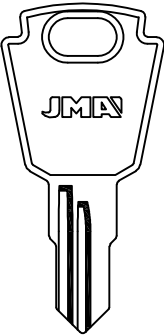
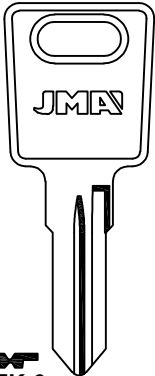
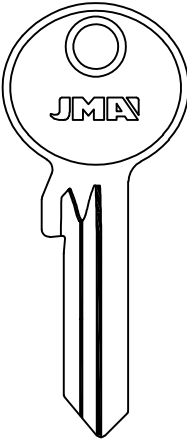
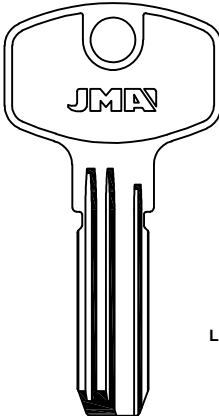
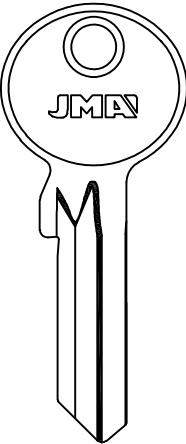
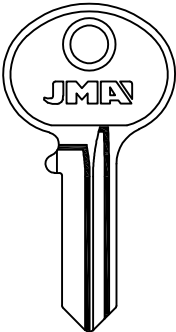
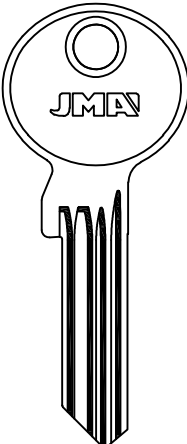
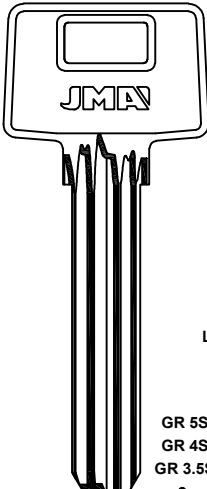

FOR: GTV®	FOR: GUARD®	FOR: GUSHENG®	FOR: HÄFELE®
 <p><b>GTV-12</b> NEW</p>	 <p><b>GUA-5</b> NEW</p> <p><b>GUA-4</b> NEW</p>	 <p><b>GUS-1</b> NEW</p>	 <p><b>HAF-6</b> NEW</p> <p>FOR: WSS®-WÜRTH®</p>
FOR: HAHN&KOLB®	FOR: HEKNA®	FOR: HFM®	FOR: HOK®
 <p><b>HKO-1D</b> NEW</p>	 <p><b>HEK-6</b> NEW</p> <p><b>HEK-5</b> NEW</p> <p>...1501-1540</p> <p><b>HEK-4</b>   <b>HEK-4D</b> NEW</p> <p>FOR: METALCASTELLI® FOR: RAUCO®-REGENT®</p>	 <p><b>HF-1D</b> NEW</p>	 <p>LAT.</p> <p><b>HOK-1D</b> NEW</p> <p>9.20 2.50</p> <p>FOR: MEGA®</p>
FOR: HOK®	FOR: HUDSON®	FOR: HUGO®	
 <p><b>HOK-2D</b> NEW</p> <p>FOR: MEGA®</p>	 <p>LAT.</p> <p>... 01-175</p> <p><b>HUD-3</b>   <b>HUD-3D</b> NEW</p>	 <p><b>HGO-1</b> NEW</p>	 <p>LAT.</p> <p>GR 5S GR 4S GR 3.5S</p> <p>9 2.95</p> <p><b>HGO-2D</b> NEW</p>

**FOR:**

- GTV® (DE)
- GUARD® (HK)
- GUSHENG® (DE)
- HÄFELE® (D)
- HAHN & KOLB® (DE)
- HEKNA® (DE)
- HFM® (DE)
- HOK® (TR)
- HUDSON® (US)
- HUGO® (DE)



FOR:

- IFAM® (ES)
- IKON® (DE)
- ISEO® (IT)
- ISUZU® (JP)
- ITO® (TR)
- IVANA® (DE)
- KABA® (CH)
- KALE® (TR)
- KESO® (CH)

FOR: IFAM®

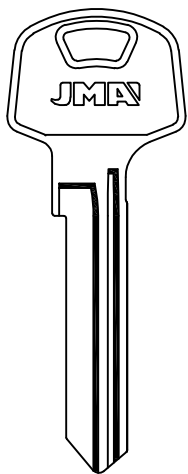

IF-7  
NEW

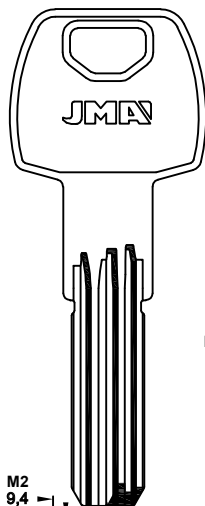

M2 9.4  
IF-8 2.9  
NEW

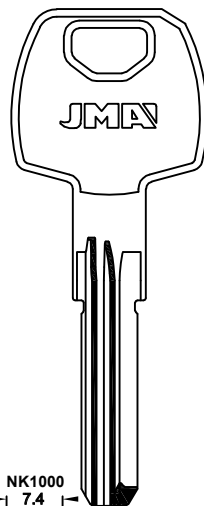

NK1000 7.4  
IF-9 2.9  
NEW

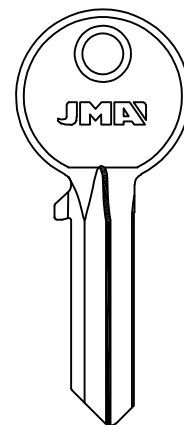

F5S  
IF-10D  
NEW

LAT.

LAT.

FOR: IKON®

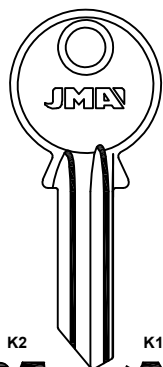

K2  
ZE-K2

K1  
ZE-K1

K6  
ZE-K6

K5  
ZE-K5

NEW ZE-160D

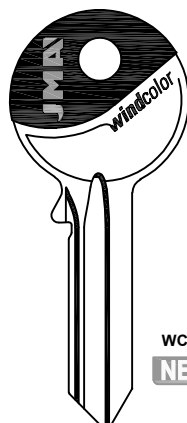

WCOLOR  
NEW

F5  
IS-3D

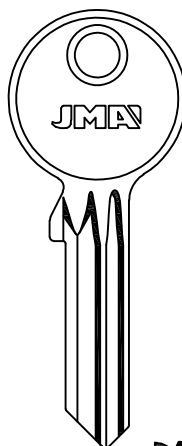

F3  
IS-15

IS-21D  
NEW

FOR: ISEO SILVER®

FOR: ITO®

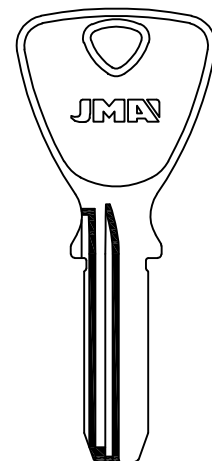

LAT.

8.5  
ITO-3D 2.4  
NEW

FOR: CORONA® -FORT® -SCHRITT®

FOR: IVANA®

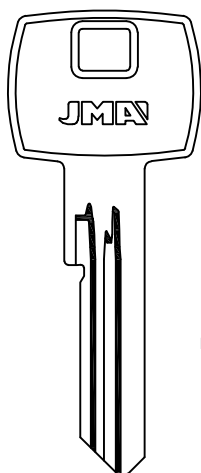

LAT.

IV-3D  
NEW

FOR: KABA®

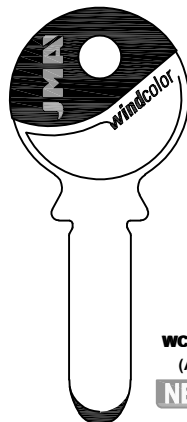

WCOLOR  
(ALP.)  
NEW

7.85  
8  
1.95  
KA-7

FOR: LASBOLAGET®

FOR: KALE®

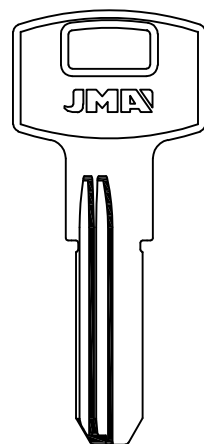

LAT.

8.8  
2.25  
KAE-15D  
NEW

FOR: KESO®

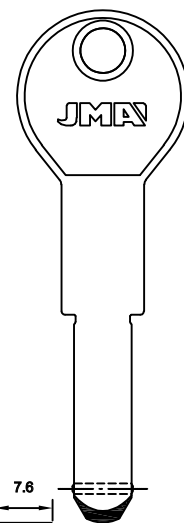

ALP.

7.6  
2.45  
KE-6  
NEW

JMA®



ATENCIÓN: Concerniente a las marcas y denominaciones comerciales ver nota en índice.  
 ATTENTION: Concerning the marks and commercial denominations see note in index.  
 ATTENTION: Concernant les marques et dénominations commerciales voir la note dans l'index.  
 ACHTUNG: Beziehen auf die marke und handelsname sehen sie die notiz im index.



FOR: KESO®

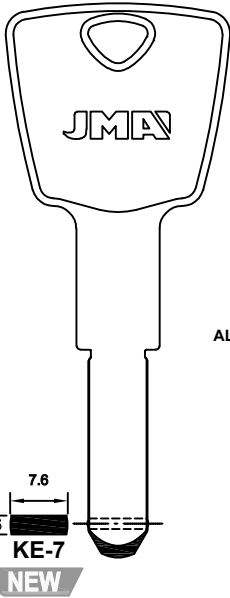

FOR: KJV®

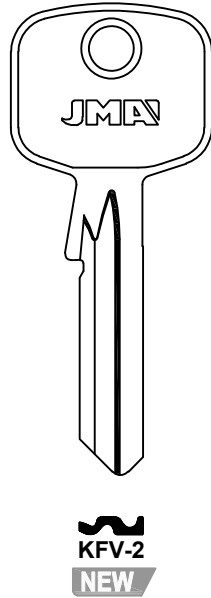

FOR: KWIKSET®

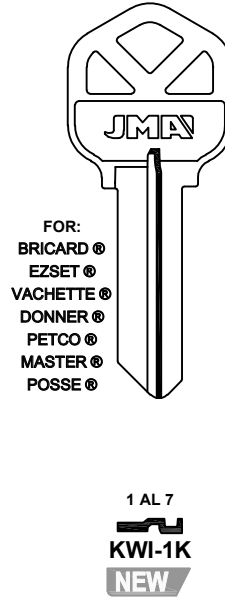

FOR:

- KESO® (CH)
- KJV® (DE)
- KWIKSET® (US)
- LAPERCHE® (FR)
- LINCE® (ES)
- LOB® (PL)

FOR: LAPERCHE®

- NEW BEA LAP-53
- NEW ADA LAP-57
- NEW ADD LAP-71
- BDC LAP-88
- NEW AEB LAP-93
- NEW BFB LAP-98

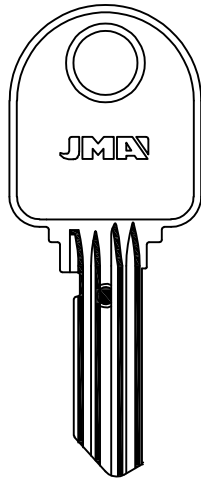

FOR: FICHET®

FOR: LINCE®

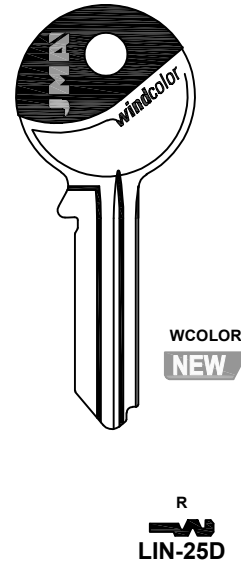
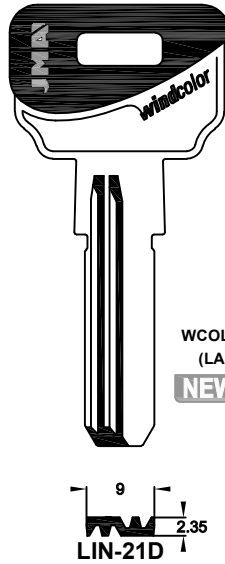

FOR: LINCE®

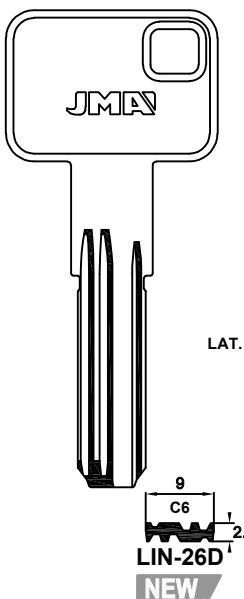

FOR: LOB®

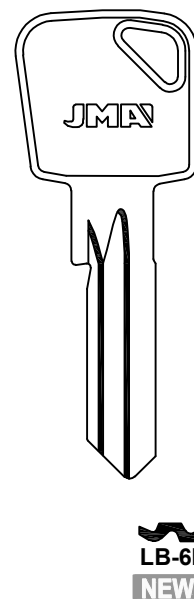
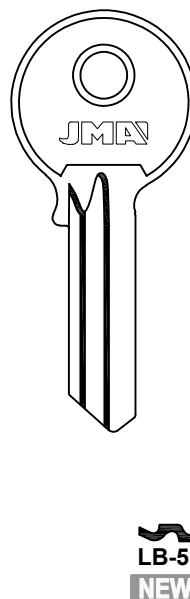
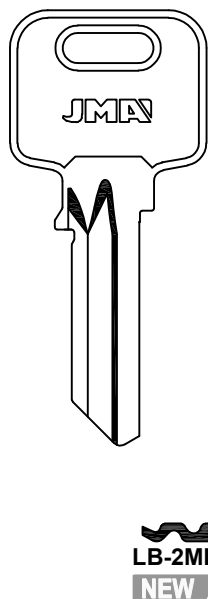

**FOR:**

LOWE &  
FLETCHER®  
(GB)

MARQUES® (PT)

MAUER® (NL)

MCM® (ES)

MECO® (DE)

**FOR: LOWE & FLETCHER®**

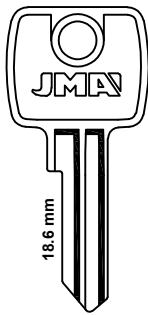

18.6 mm



60... 001-200  
60... 001-200  
90... 001-200  
...1-400  
GHM...1-155  
M...1-400  
RV...1-400  
RVM...1-400  
SP...1-400  
99...1-400



LF-15

FFE

001-100



LF-17



NEW

LF-47

FOR: CEM® -EURO LOCKS® -ULTRA® -UNION®

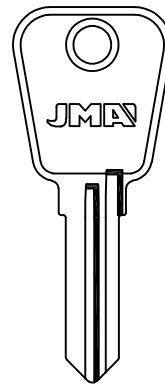

LF-41



NEW

LF-51

FOR: FKS®

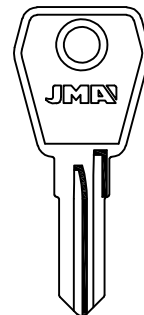

LF-46



LF-50D

NEW

**FOR: MARQUES®**

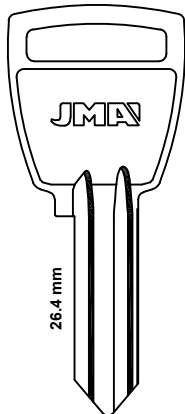

26.4 mm



MQ-2

NEW

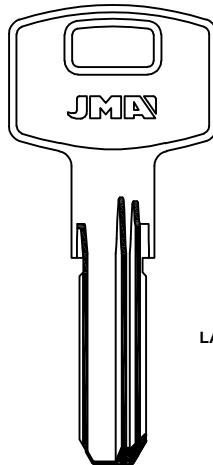

LAT.

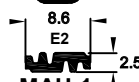

MAU-1

NEW

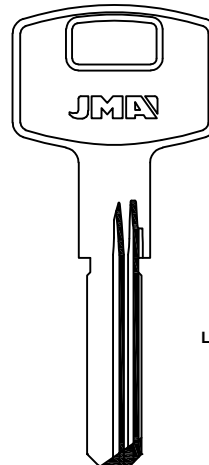

LAT.

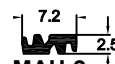

MAU-2

NEW

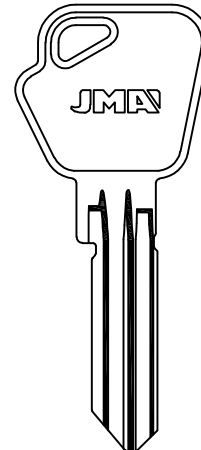

LAT.



MAU-3D

NEW

**FOR: MAUER®**

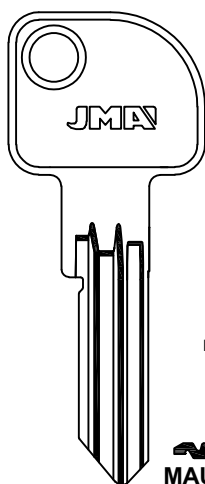

LAT.



MAU-5D

NEW



MAU-4D

NEW

FOR: DEKABA®

**FOR: MCM®**

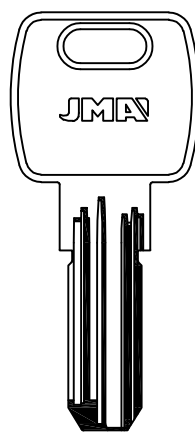

LAT.



MCM-15E8

NEW

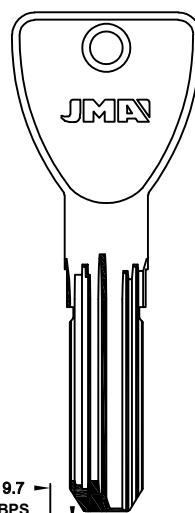

LAT.

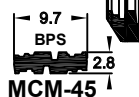

MCM-45

NEW

**FOR: MECO®**

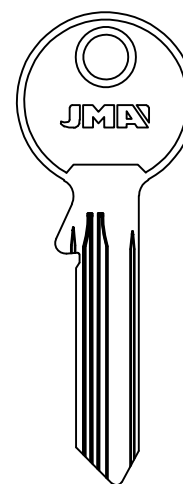

MEC-6

NEW

**JMA®**

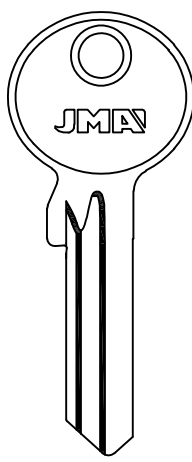
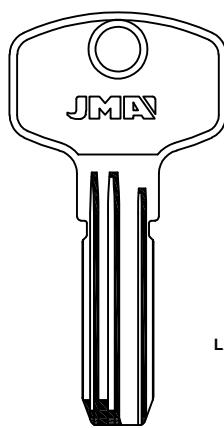
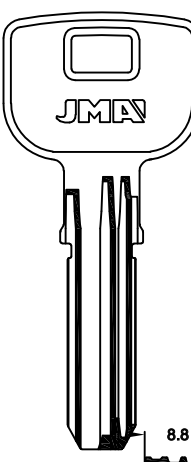
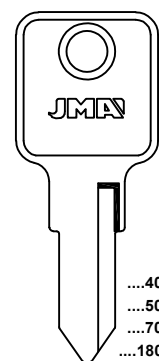

ATENCIÓN: Concerniente a las marcas y denominaciones comerciales ver nota en índice.  
ATTENTION: Concerning the marks and commercial denominations see note in index.  
ATTENTION: Concernant les marques et dénominations commerciales voir la note dans l'index.  
ACHTUNG: Beziehen auf die marke und handelsname sehen sie die notiz im index.

<p><b>FOR: MEDOS®</b></p>  <p><b>NEW</b> MED-1D</p>	<p><b>FOR: MEGA®</b></p>  <p>LAT.</p> <p><b>NEW</b> MEG-1D</p> <p>FOR: HOK®</p>	<p><b>FOR: MHA®</b></p>  <p>LAT.</p> <p><b>NEW</b> MH-1</p> <p><b>NEW</b> MH-2D</p> <p>FOR: TOP LOCK®</p>	<p><b>FOR: MLM®</b></p>  <p>.....4001-4100 .....5000-5100 .....7001-7499 .....18001-18100</p> <p>MLM-2</p> <p>MLM-5</p> <p>MLM-9 <b>NEW</b></p> <p>FOR: DOM® -LEHMANN® -ORDO® -STUV®</p>
--	--	--	---

**FOR:**  
 MEDOS® (PL)  
 MEGA® (RO)  
 MHA® (CN)  
 MLM® (DE)  
 MOTTURA® (IT)  
 MUEL® (FR)  
 NEMEF® (DE)  
 NOORI® (DE)

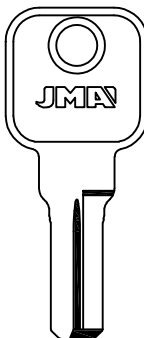
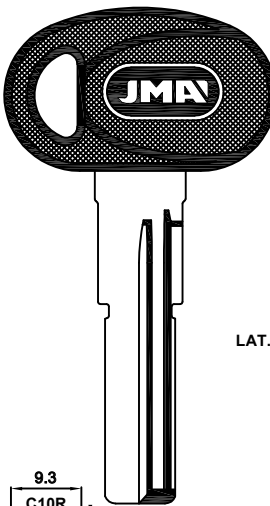
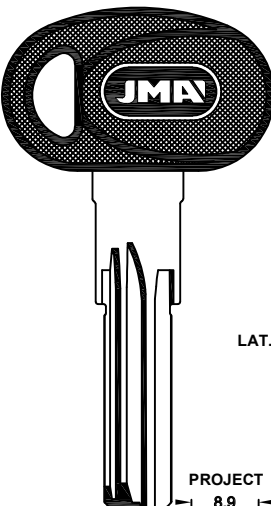
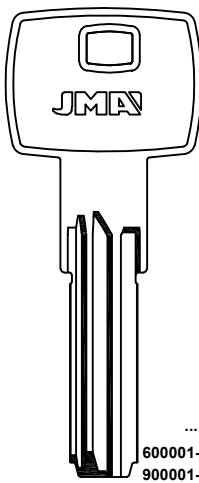
<p><b>FOR: MLM®</b></p>  <p>LAT.</p> <p><b>NEW</b> MLM-8</p> <p>FOR: LEHMANN®</p>	<p><b>FOR: MOTTURA®</b></p>  <p>LAT.</p> <p><b>NEW</b> MT-1.P</p>	<p><b>FOR: MOTTURA®</b></p>  <p>LAT.</p> <p>PROJECT</p> <p><b>NEW</b> MT-2D.P</p>	<p><b>FOR: MOTTURA®</b></p>  <p>LAT.</p> <p>..... 600001-613040 900001-902780</p> <p><b>NEW</b> MT-2D</p> <p>FOR: GEVY® -STV®</p>
---	---	---	---

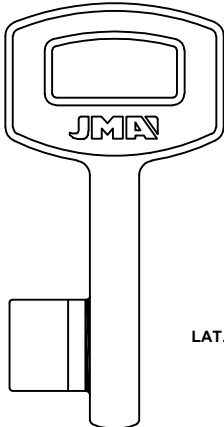
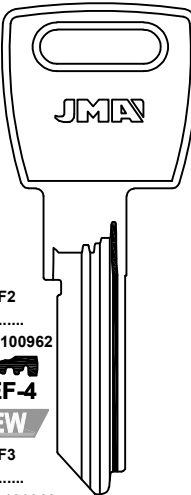
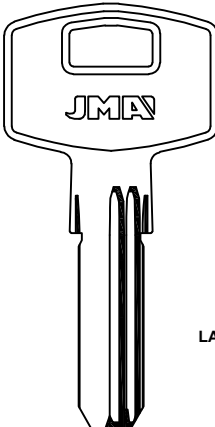
<p><b>FOR: MUEL®</b></p>  <p>LAT.</p> <p><b>NEW</b> MUE-2</p> <p><b>NEW</b> MUE-1</p>	<p><b>FOR: NEMEF®</b></p>  <p>NF2 N5..... 000001-100962</p> <p><b>NEW</b> NEF-4</p> <p>NF3 N5..... 000001-100962</p> <p><b>NEW</b> NEF-3</p>	<p><b>FOR: NOORI®</b></p>  <p>LAT.</p> <p><b>NEW</b> NOR-1</p> <p>FOR: IBFM®</p>
--	---	---





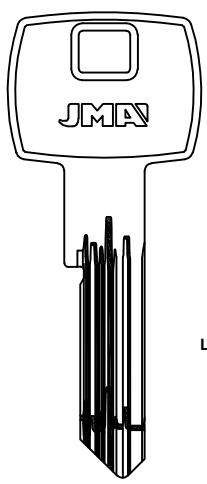
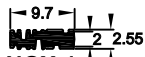
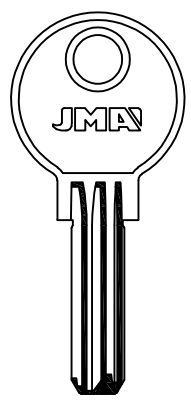
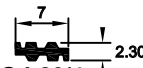
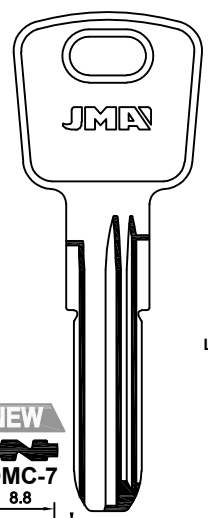
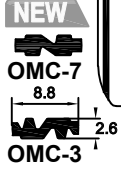



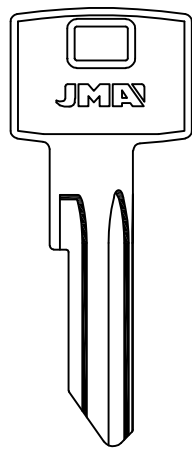



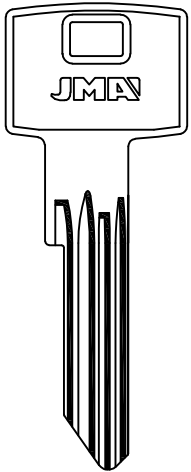

**FOR:**  
 NOXXA® (NL)  
 OJMAR® (ES)  
 OMEC® (IT)  
 PFAFFENHAIN®  
 (DE)  
 POTENT® (IT)  
 PREFER® (IT)

FOR: NOXXA®	FOR: OJMAR®	FOR: OMEC®
 <p>LAT.</p>  <p>NOX-1 NEW</p>	 <p>LAT.</p>  <p>OJ-20/4 NEW</p>	 <p>LAT.</p>  <p>NEW OMC-7 OMC-3</p> <p>FOR: SANTOS® - CAIB®</p>

**FOR: PFAFFENHAIN®**

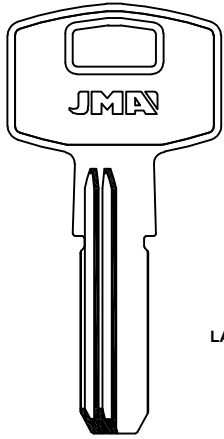

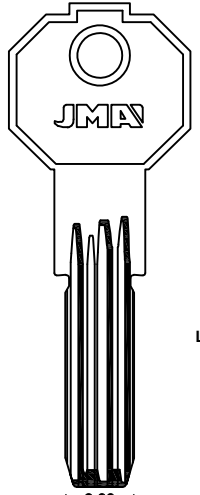
	EA PFA-13D	
	EB PFA-14D	
	EH PFA-15D	
A21 PFA-10D	EN PFA-16D	
A22 PFA-11D	RF PFA-17D	T21 AL T26-T28 T31 AL T42 T44 AL T46 T51-T54-T65 T85-T86-T91 PFA-22
A23 PFA-12D	RG PFA-18D	A40 PFA-23D FOR: FINA® NEW
PFA-4		A40 PFA-22D FOR: ABUS®

FOR: PFAFFENHAIN®	FOR: POTENT®	FOR: PREFER®
 <p>LAT.</p>  <p>PFA-6</p>  <p>A24 PFA-6D</p>  <p>PFA-21</p>  <p>PFA-24 NEW</p>  <p>PFA-25 NEW</p>  <p>PFA-24D NEW</p>  <p>PFA-25D NEW</p>  <p>PFA-26D NEW</p>	 <p>LAT.</p>  <p>PTN-3D NEW</p>	 <p>LAT.</p>  <p>PR-21 NEW</p>



FOR: PREFER®

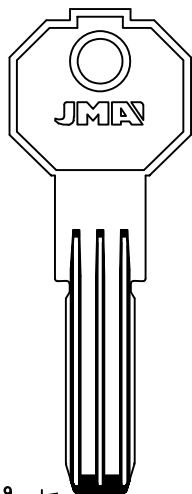

LAT.



PR-22

NEW

FOR: RENZ®

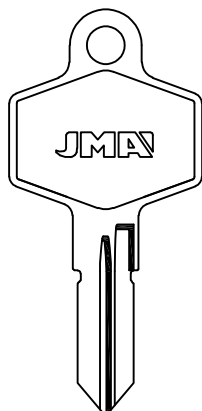
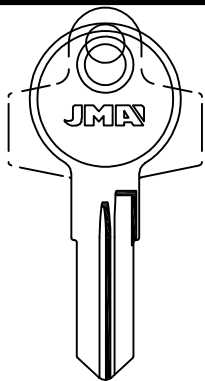

RE-5

NEW



RE-5D



RE-6

NEW



RE-6D

NEW

FOR: EURO LOCKS®

FOR: RODES®

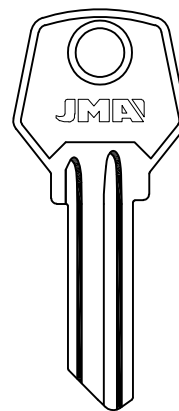

ROD-1

NEW



ROD-1D

NEW

FOR:

- PREFER® (IT)
- RENZ® (DE)
- RODES® (PT)
- RONIS® (FR)
- RUKO® (DK)
- RUSSIA® (RU)

FOR: RONIS®

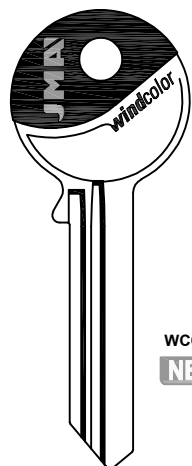

WCOLOR

NEW

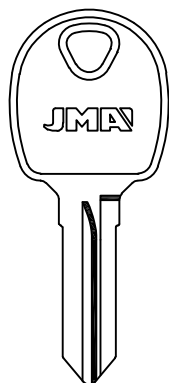

RO-43

NEW

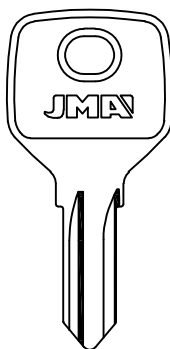

RO-46

NEW



RO-29D

CA

RO-44D

NEW

NEW



RO-45

FOR: STUV®-WSS®

FOR: RUKO®

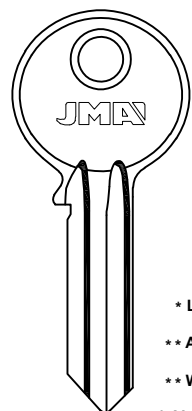

\* LAT.

\*\* ALU.

\*\* WColor

- .....1 AL 8
- .....1 AL 9
- .....1 AL 9 AL 0 A-B
- .....0 AL 9 A AL M
- S.....1 AL 9



RU-1

NEW



\*\* RU-1D

FOR: DIFA®



RU-21



RU-2D



RU-3D



RU-4D



RU-10D



\* RU-19D



RU-TL

FOR: DIFA®

FOR: RUSSIA®

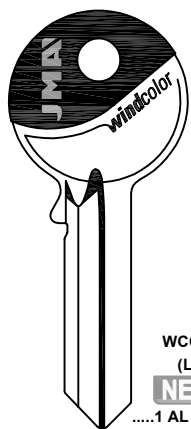

WCOLOR

(LAT.)

NEW

- .....1 AL 8
- .....1 AL 9
- .....1 AL 9 AL 0 A-B
- .....0 AL 9 A AL M
- S.....1 AL 9



RU-1D

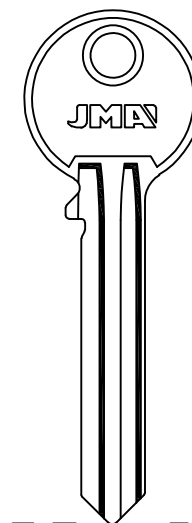

RSS-3

NEW



RSS-3D

NEW



FOR:

FOR: SAMSONITE®

FOR: SEA®

FOR: SECUREMME®

FOR: SHAW WALKER®

SAMSONITE®  
(US)

SEA® (CH)

SECUREMME®  
(IT)

SHAW WALKER®  
(US)

STANDERS®  
(ES)

TECHNO® (DE)

TECON® (ES)

TESA® (ES)

TITAN® (SI)

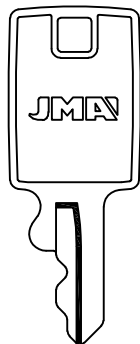

SA-5D  
NEW

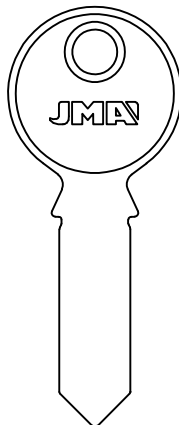

ALP.

.....1 AL 7  
9.4  
2.2  
NEW SEA-2  
FOR:  
EZCURRA® -HASLER® -VIDMAR®

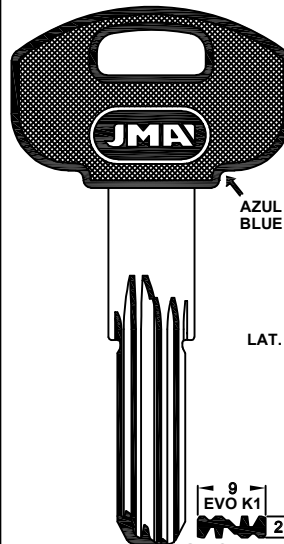

AZUL  
BLUE

LAT.

9 EVO K1  
2.8  
NEW SEC-4D.P

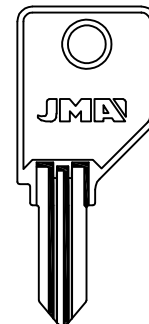

LAT.

NEW SWL-1  
FOR: STORWALL®

FOR: STANDERS®

FOR: TECHNO®

FOR: TECON®

FOR: TESA®

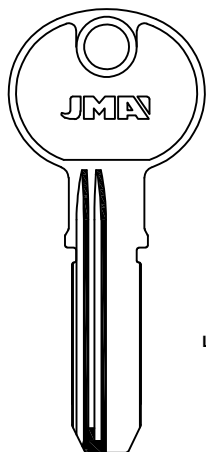

LAT.

8.85  
2.95  
NEW STN-1D  
FOR: FTH®

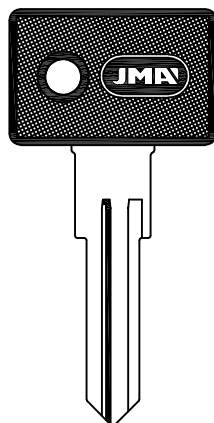

NEW TCH-1.P  
NEW TCH-1D.P  
FOR: ET.POWER®  
FOR: STARRY LOCK® -STHALEX®

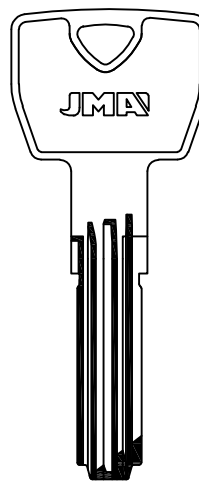

LAT.

WF  
8.3  
2.8  
NEW TC-3

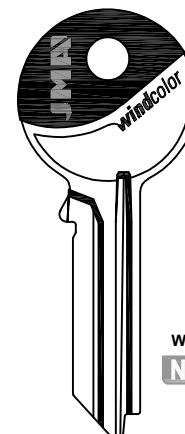

WCOLOR  
NEW

T.....  
0 AL 9  
TE-81

FOR: TESA®

FOR: TITAN®

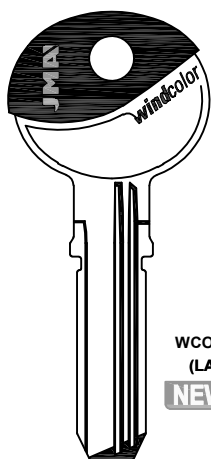

WCOLOR  
(LAT.)  
NEW

8.9  
2.8  
TE-T60

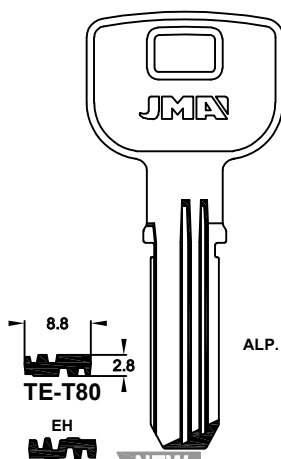

ALP.

8.8  
2.8  
TE-T80  
EH  
TE-T80EH  
NEW  
SC  
TE-T80SC

FOR: THOMAS LAIDLAW® -ESAFE® -STS® -TOPLOCK® -YEMAR®

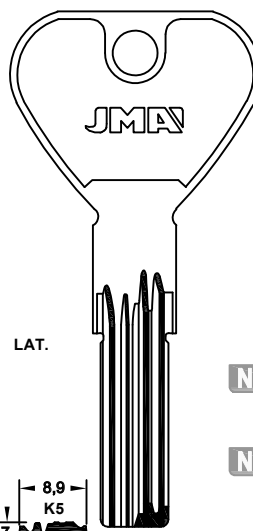

LAT.

8.9  
K5  
2.7  
TIT-21  
NEW

FOR: UCEM®

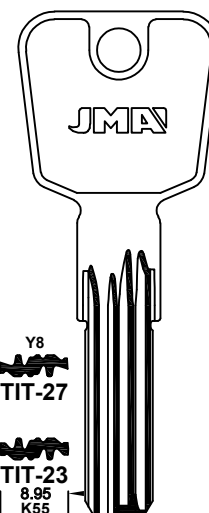

LAT.

Y8  
NEW TIT-27  
NEW TIT-23  
8.95  
K55  
2.8  
TIT-22  
NEW

FOR: HERACLES®

JMA®



ATENCIÓN: Concerniente a las marcas y denominaciones comerciales ver nota en índice.  
ATTENTION: Concerning the marks and commercial denominations see note in index.  
ATTENTION: Concernant les marques et dénominations commerciales voir la note dans l'index.  
ACHTUNG: Beziehen auf die marke und handelsname sehen sie die notiz im index.

FOR: TITAN®

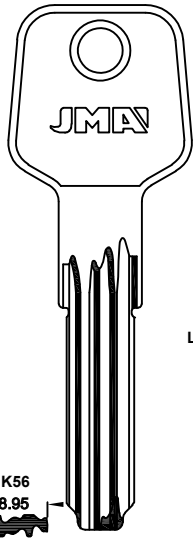
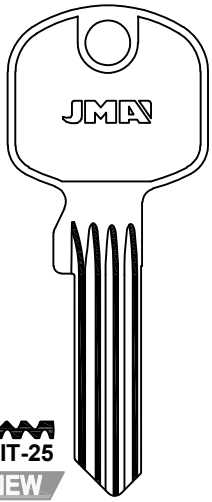

LAT.

TIT-25  
NEW

TIT-24  
NEW

K56  
8.95  
2.8  
TIT-26  
NEW

FOR: BASI®

FOR: TOK WINKHAUS®

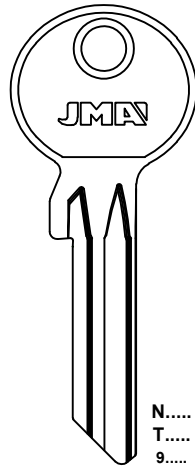

TOK-6

N.....  
T.....  
9.....  
.....9  
0 AL 8  
TOK-6D

TOK-83  
NEW  
TOK-27

TOK-26

TOK-25

TOK-83D  
NEW

FOR:

- TITAN® (SI)
- TOK WINKHAUS® (DE)
- TOUCH® (GB)
- TOVER® (ES)
- TRELOCK® (DE)

FOR: TOK WINKHAUS®

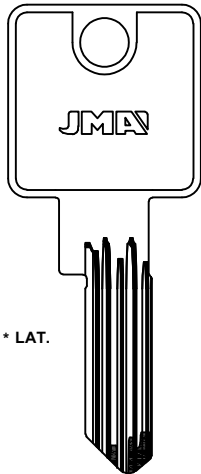

\* LAT.

ENAX  
TOK-7D

TOK-32

TOK-33

TOK-86D  
NEW

EAFF  
TOK-23

TOK-28D

\* TOK-85D  
NEW

TOK-15

BFA1  
TOK-16D

\* TOK-84D  
NEW

BFA2  
TOK-13D

BYNY1  
TOK-14D

TOK-82  
NEW

EFAM  
EFWS  
TOK-11

EWSB  
TOK-12

BFA3  
\* BIF-1

EVB  
TOK-88D  
NEW

EHBA  
EKCP  
TOK-9

FAABF  
TOK-10D

TOK-34D

TOK-87D  
NEW

FOR: FICHET® - BIFFAR® - SCHURICO® - FAR-WINKHAUS

FOR: TOUCH®

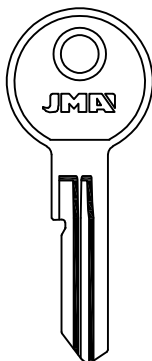

NEW  
TOU-1D

FOR: FKS®

FOR: TOVER®

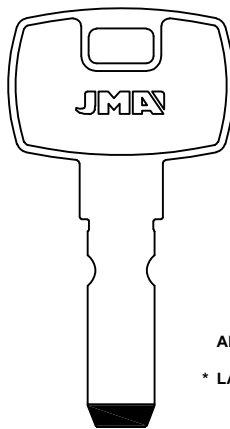

ALP.

\* LAT.

2F35  
8.85  
2.45  
TOV-4  
\* TOV-8D  
NEW

FOR: TROMER®

FOR: TRELOCK®

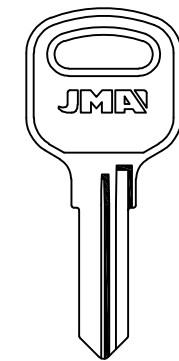

TRL-3  
NEW

TRL-3D  
NEW

TRL-5.P  
NEW

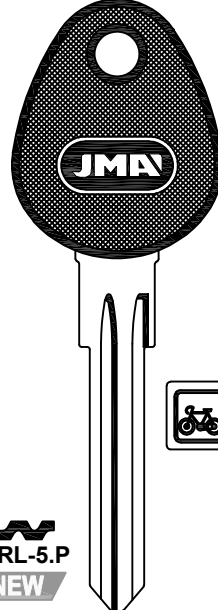

FOR:  
 TRELOCK® (DE)  
 TRI CIRCLE® (TW)  
 TRIO-VING® (NO)  
 UCEM® (ES)

FOR: TRELOCK®	TRI-CIRCLE		FOR: TRIO-VING®

**FOR: TRIO-VING®**

		* * * * * * *	* * * * * * *	*      *	* 
--	--	---------------------------------	---------------------------------	----------------------------	-------

LAT.      \* LAT.

.....123456789A  
  
 FOR: JOLI SAFE®

**FOR: UCEM®**

LAT.      ALP.

FOR: TITAN®      FOR: REMOCON®





FOR: UCEM®

UNIVERSAL

FOR:

UCEM® (ES)

UNIVERSAL

VACHETTE® (FR)

VARIOS

WILKA® (DE)

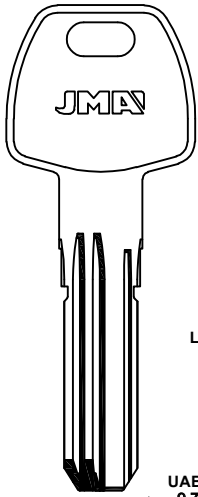

LAT.

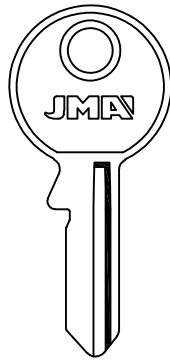
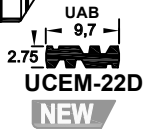

FOR: FLOK®

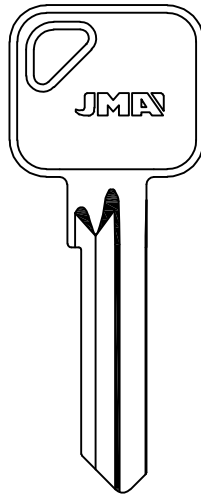

FOR: EURO SPEC®

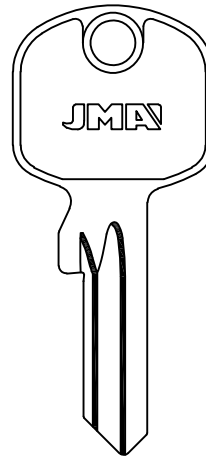

UNIVERSAL

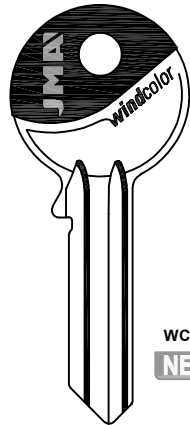
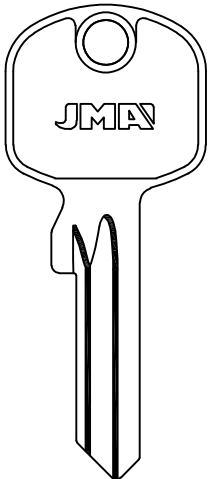

WCOLOR  
NEW



FOR: ESAFE® -SIL®

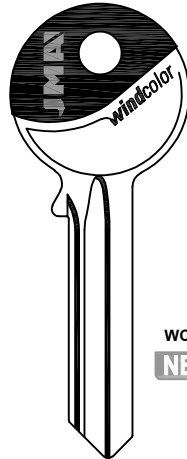

WCOLOR  
NEW

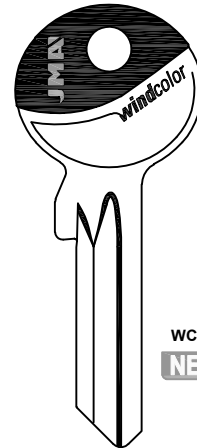

WCOLOR  
NEW



FOR: VACHETTE®

VARIOS

FOR: WILKA®

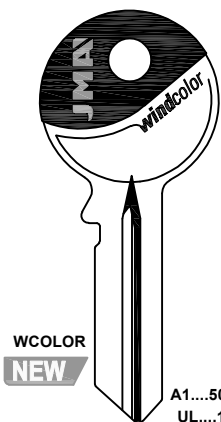

WCOLOR  
NEW

A1.....5001-5631  
UL.....1-3500  
U.....1 AL 9 AL 0



VA-75D

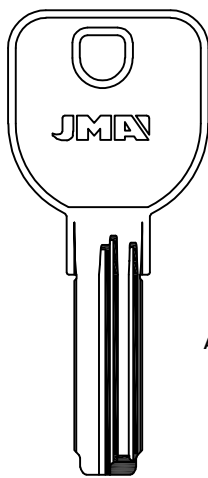

ALP.



VA-91  
NEW

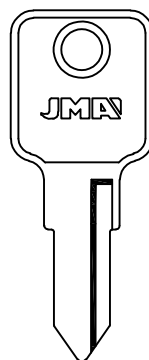

PL-1  
NEW

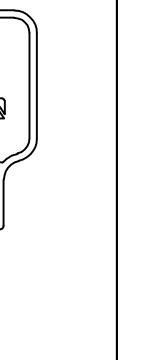

PL-1D  
NEW

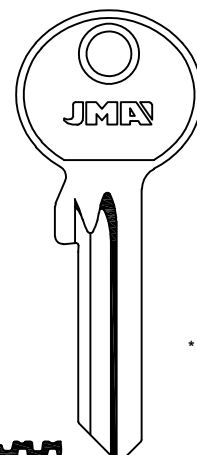

WIL-23  
NEW

\* MTIC.



FOR: JORE® -WIGRO®

JMA®



Copyright by Alejandro Altuna S.L.U. 2021

ATENCIÓN: Concerniente a las marcas y denominaciones comerciales ver nota en índice.  
ATTENTION: Concerning the marks and commercial denominations see note in index.  
ATTENTION: Concernant les marques et dénominations commerciales voir la note dans l'index.  
ACHTUNG: Beziehen auf die marke und handelsname sehen sie die notiz im index.

**FOR:**

- WILKA® (DE)
- YALE® (GB)
- YARDENI® (IL)
- YETI® (TW)
- YUN HUAN® (CN)

**FOR: WILKA®**

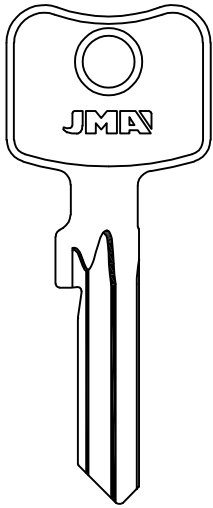

**NEW** WIL-66D

FOR: BIFFAR® -BEFA®

**FOR: YALE®**

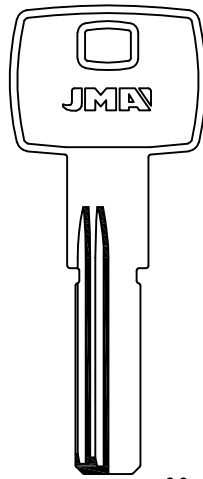

LAT.

8.6  
**NEW** YA-280D<sup>1</sup>

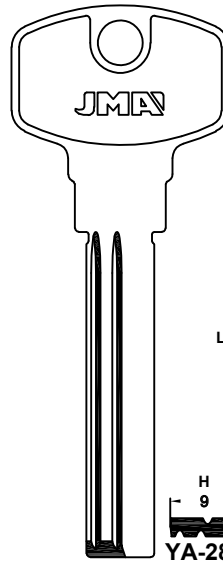

LAT.

H 9 2.4  
**NEW** YA-281D<sup>1</sup>

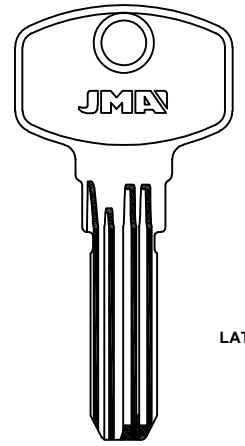

LAT.

1000  
8.80 2.80  
**NEW** YA-282<sup>1</sup>

**FOR: YALE®**

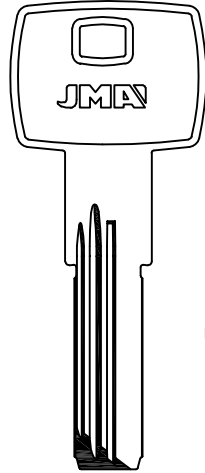

LAT.

9 2.8  
**NEW** YA-283D<sup>1</sup>

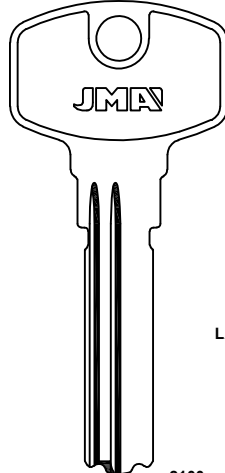

LAT.

2100 9 2.5  
**NEW** YA-286D<sup>1</sup>

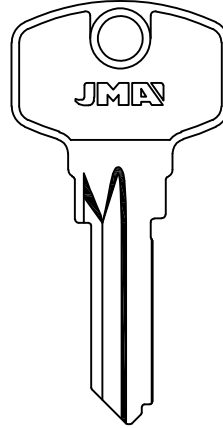

YL5-30D  
**NEW** YA-300D

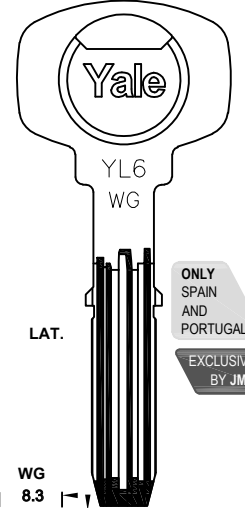

LAT.

ONLY SPAIN AND PORTUGAL  
EXCLUSIVE BY JMA

WG 8.3 2.8  
**NEW** YA-306<sup>1</sup>

**FOR: YARDENI®**

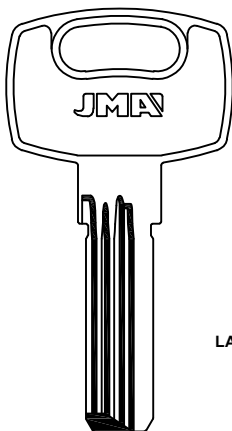

LAT.

8.9 2.45  
**NEW** YAR-4D  
**NEW** YAR-3

**FOR: YETI®**

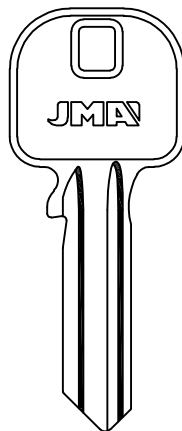

AD195  
**NEW** YET-18

**NEW** YET-18D

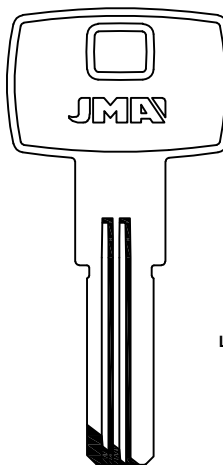

LAT.

8.8 2.5  
**NEW** YET-19D<sup>1</sup>

FOR: LOB®

**FOR: YUN HUAN®**

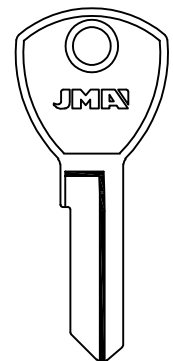

**NEW** YUH-3D



# **LLAVES PARA VEHÍCULOS**

**IBILGAILUENTZAKO GILTZAK**

**KEYS FOR VEHICLES**

**CLÉS POUR VÉHICULES**

**FAHRZAUGESCHLÜSSEL**



**SUPLEMENTO-SUPPLEMENT**

**C11.2021**

**THE KEY TO EXCELLENCE**  
GLOBALLY UNLOCKING MILLIONS OF DOORS DAILY

**FOR:**

ABUS® (DE)

AXA® (ES)

DACIA® (R)

EURO LOCKS®  
(BE)

FORD® (USA)

GAD® (NL)

**FOR: ABUS®**



1-331  
X61...

X62...  
V62...

**ABU-35.P**

**ABU-35D.P**

**NEW**

1-331  
V61...

V62...

**ABU-36.P**

FOR: BUFFO®



NW52

**ABU-87.P**

**NEW**



NW72

**ABU-88.P**

**NEW**

**FOR: AXA®**

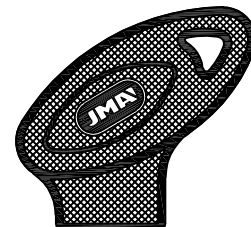

LAT.

DEFENDER

**AX-2.P1**

VICTORY

**AX-5D.P1**

**NEW**

FOR: BUFFO®

**FOR: DACIA®**



FOR: HUF®

**NEW**

**DAC-4D.P**



**NEW**

**DAC-7DC1**

**DAC-4DC1**

FOR: HUF®



**DAC-6DC1**

**NEW**

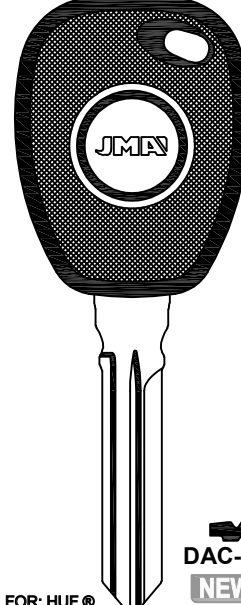

FOR: HUF®

**DAC-6D.P**

**NEW**

**FOR: EURO LOCKS®**



LAT.

7,6  
2,9  
**EU-15.P**

**NEW**

FOR: HOBBY® -HYMER®

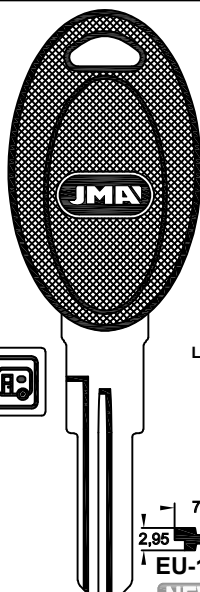

LAT.

7,2  
2,95  
**EU-16DP**

**NEW**

FOR: HOBBY®

**FOR: FORD®**

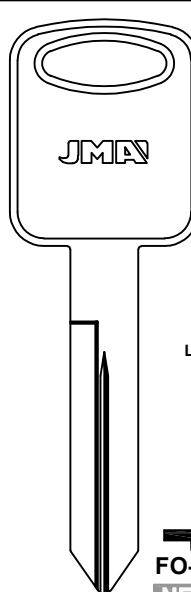

LAT.

**FO-43D**

**NEW**

**FOR: GAD®**

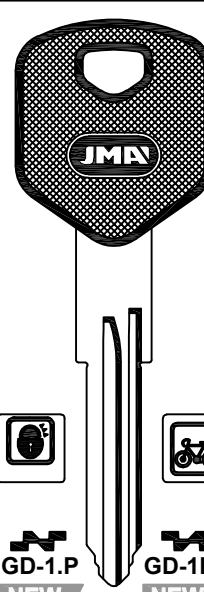

**GD-1.P**

**NEW**



**GD-1D.P**

**NEW**



FOR: GIVI®

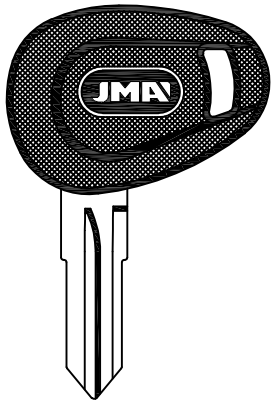

NEW GIV-2D.P

GIV-1.P  
NEW

FOR: HUF®

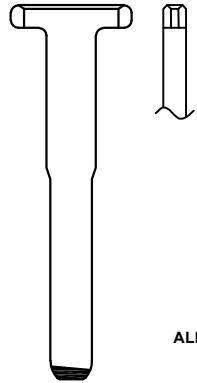

ALP.

...1-4000  
5.45  
3  
FO-24C3  
NEW

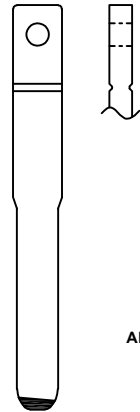

ALP.

...1-4000  
5.45  
3  
FO-24C8  
NEW

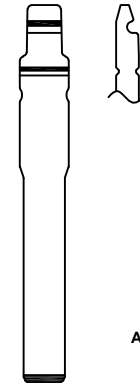

ALP.

NEW  
...1-4000  
5.45  
3  
FO-24C9  
FORD®  
WITTE®

FOR:

- GIVI® (IT)
- HUF® (DE)
- HYUNDAI® (KR)

FOR: HUF®

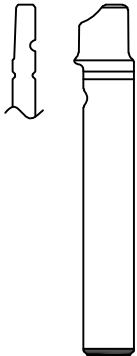

ALP.

NEW HU-7C1

NEW HU-4C1  
6.65  
3

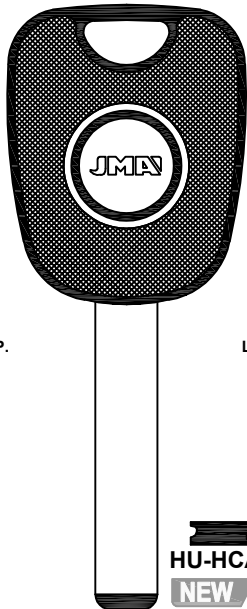

LAT.

HU-HCA.P  
NEW



ALP.

NEW  
...0001-3679  
Z...1-2000  
Z...2001-4000  
Z...4001-6314  
6.4  
3  
OP-11C3  
FOR: OPEL®

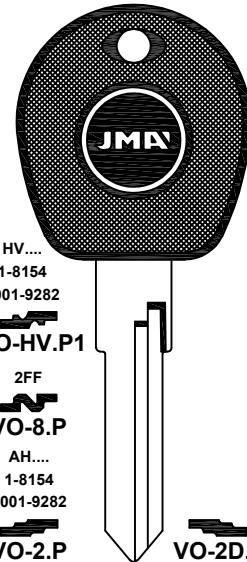

HV...  
1-8154  
1001-9282  
NEW VO-HV.P1

2FF  
VO-8.P  
AH...  
1-8154  
1001-9282  
VO-2.P

FOR: VOLKSWAGEN®  
FOR: AKS® -CASI® -UBE® -WITTE®

VO-2D.P

FOR: HUF®

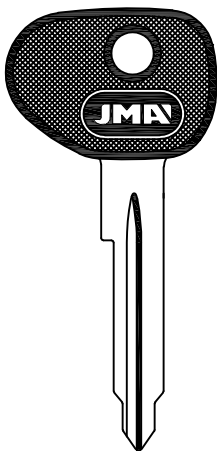

..K..  
11-72.1-110  
NEW VO-K.P  
FOR: VOLKSWAGEN®  
FOR: NEIMAN® -WITTE®

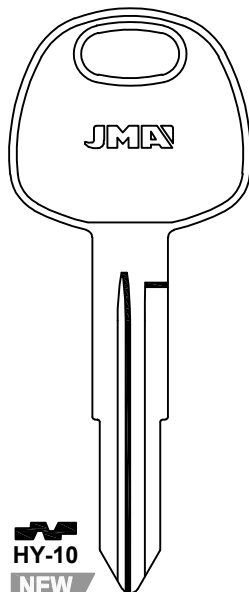

NEW HY-10

FOR: HYUNDAI®

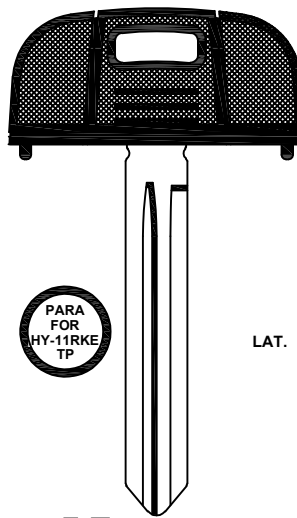

NEW HY-11.P4C1

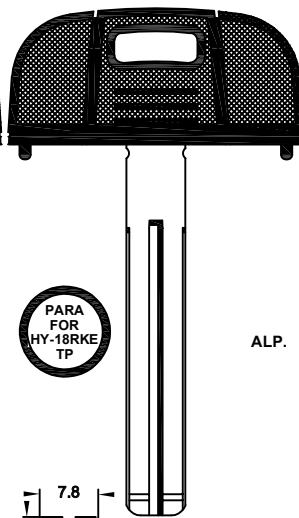

NEW HY-18.P1C1  
7.8  
2.95

FOR: KIA®











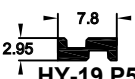
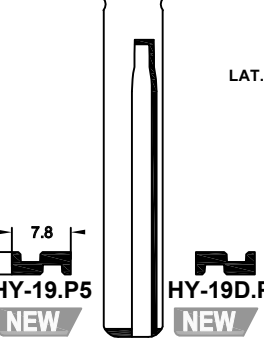

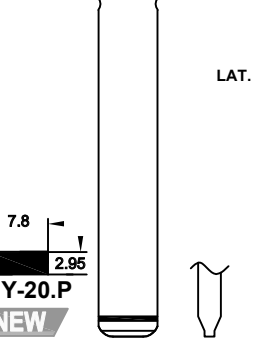

JMA®

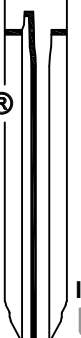
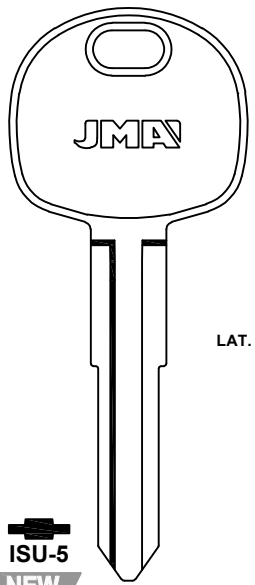

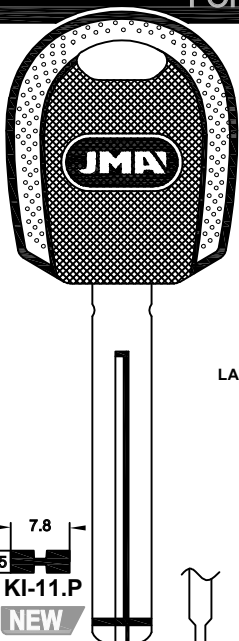
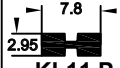
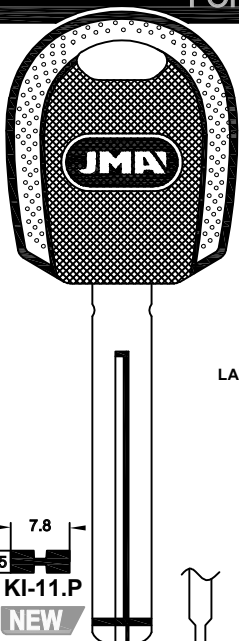
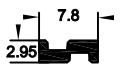
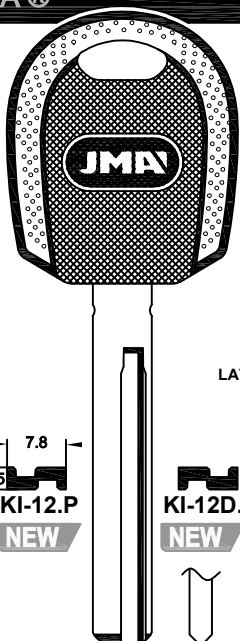
Copyright by Alejandro Altuna S.L.U. 2021

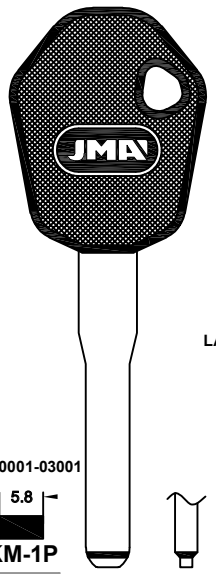
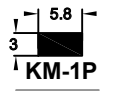
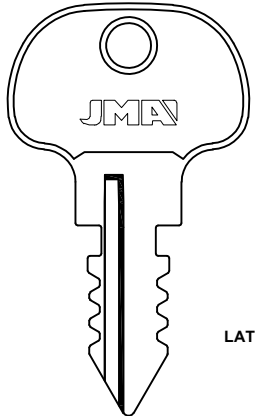
ATENCIÓN: Concerniente a las marcas y denominaciones comerciales ver nota en índice.  
 ATTENTION: Concerning the marks and commercial denominations see note in index.  
 ATTENTION: Concernant les marques et dénominations commerciales voir la note dans l'index.  
 ACHTUNG: Beziehen auf die marke und handelsname sehen sie die notiz im index.

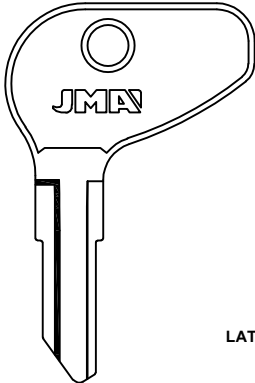
**FOR:**  
 HYUNDAI ® (K)  
 ISUZU ® (J)  
 KIA ® (K)  
 KTM ® (A)  
 KUBOTA ® (J)  
 MERIT-LINDE ®  
 (D)

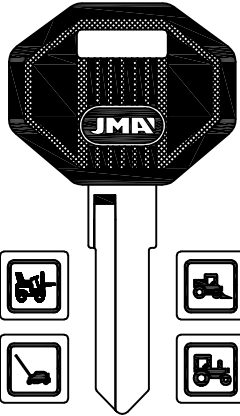
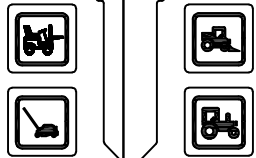
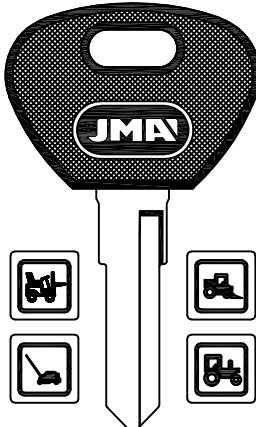
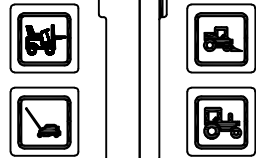
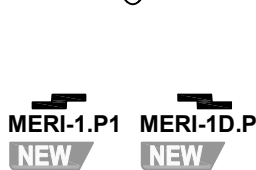
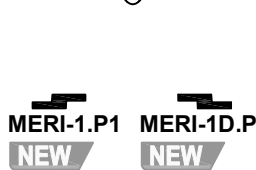
FOR: HYUNDAI ®		FOR: ISUZU ®		FOR: KIA ®		FOR: KTM ®			
 LAT.  <b>HY-19.P5</b> <b>NEW</b>	 LAT.  <b>HY-19D.P5</b> <b>NEW</b>	 LAT.  <b>HY-20.P</b> <b>NEW</b>	 LAT.  <b>HY-20D.P</b> <b>NEW</b>	 <b>FOR: ISUZU ®</b>  <b>ISU-3D.P1</b> <b>NEW</b>	 LAT.  <b>ISU-5</b> <b>NEW</b>	 LAT.  <b>KI-11.P</b> <b>NEW</b>	 LAT.  <b>KI-12.P</b> <b>NEW</b>	 LAT.  <b>KI-12D.P</b> <b>NEW</b>	 LAT.  ... 00001-03001 <b>KM-1P</b> <b>NEW</b>
FOR: KUBOTA ®				FOR: MERIT-LINDE ®					
 LAT.  <b>KUB-1D</b> <b>NEW</b>	 LAT.  <b>KUB-2D</b> <b>NEW</b>	  <b>MERI-1D.P</b>	  <b>MERI-2D.P</b> <b>NEW</b>	 <b>MERI-1.P1</b> <b>NEW</b>	 <b>MERI-1D.P1</b> <b>NEW</b>				

FOR: KUBOTA ® -MAHINDRA ® -MITSUBISHI ®



FOR: MITSUBISHI ®

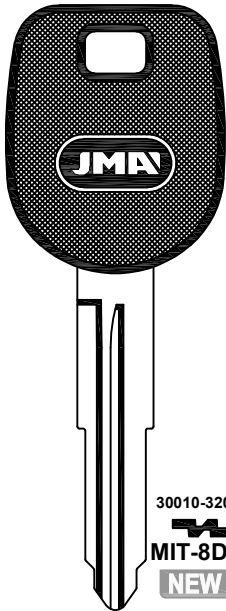

30010-32009  
MIT-8D.P2  
NEW

FOR: NEIMAN ®



..1/9....  
1/9....A/Z  
.1/9....A/Z  
..1/9....A/Z  
...1/9...A/Z  
....1/9..A/Z  
....1/9..A/Z A/Z  
.....1/9.A/Z  
M-N-P-R-S  
NE-60C3  
NEW

FOR: NISSAN ®

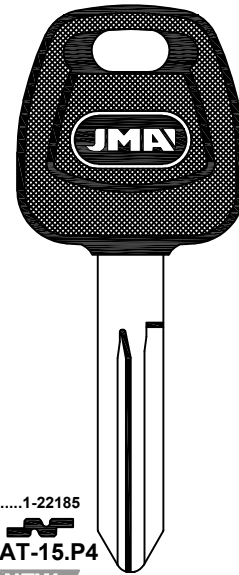

.....1-22185  
DAT-15.P4  
NEW

FOR:  
MITSUBISHI ® (J)  
NEIMAN ® (F)  
NISSAN ® (J)  
SUZUKI ® (J)  
TOYOTA ® (J)

FOR: SUZUKI ®

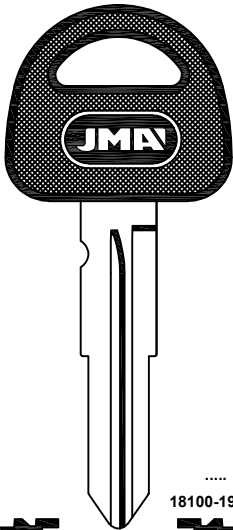

.....  
18100-19229  
SUZU-8I.P  
SUZU-8.P  
NEW FOR: SUZUKI ®

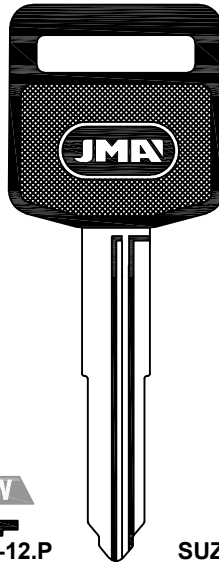

NEW  
SUZU-12.P  
6001-7000  
SUZU-12D.P  
FOR: SUZUKI ® - KAWASAKI ®

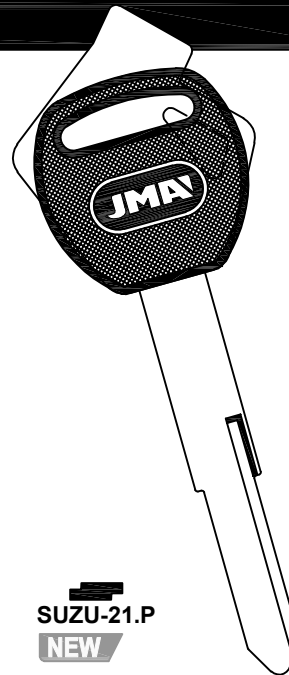

SUZU-21.P  
NEW

FOR: TOYOTA ®

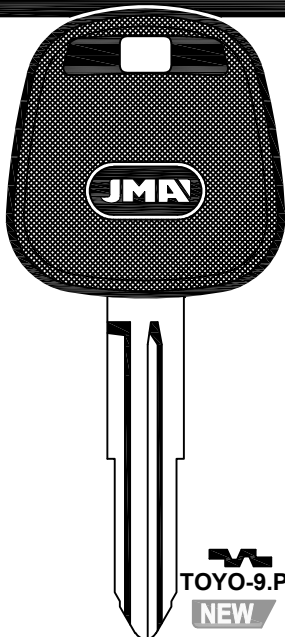

TOYO-9.P2  
NEW

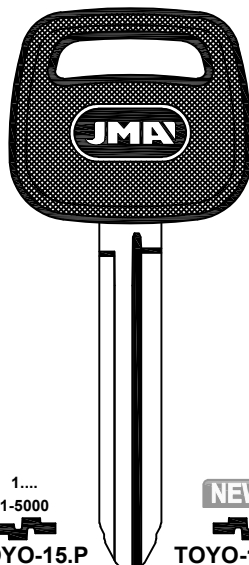

1....  
1-5000  
TOYO-15.P  
NEW  
TOYO-15D.P  
FOR: GM ® - TOYOTA ® - DAEWOO ®  
FOR: TOKAJ ® - RIKKA ®

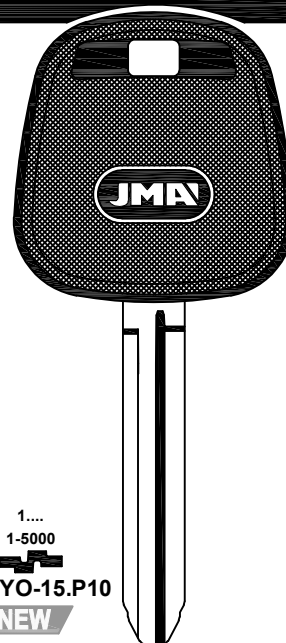







1....  
1-5000  
TOYO-15.P10  
NEW

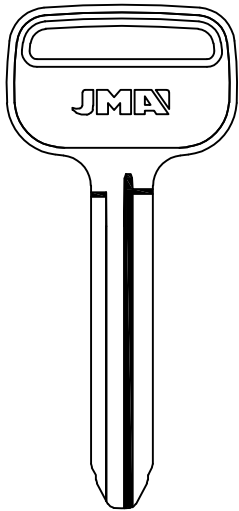

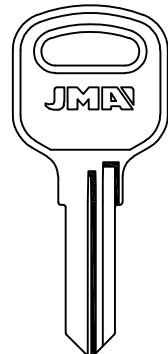
**FOR:**

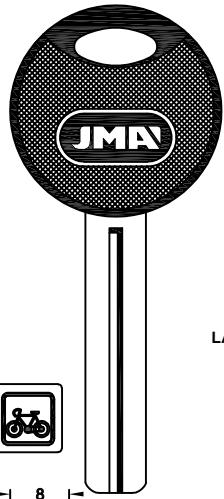
- TOYOTA® (J)
- TRELOCK® (D)
- TRIUMPH MOT.® (USA)
- TRW-SIPEA® (I)
- VACHETTE® (F)
- VALEO® (D)
- YAMAHA® (J)

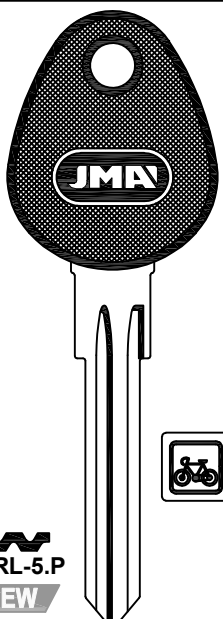
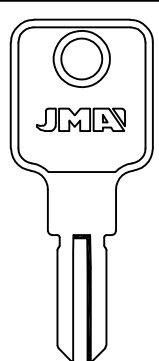
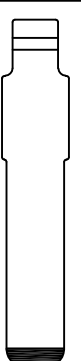
FOR: TOYOTA®		FOR: TRELOCK®			
 <p>LAT.</p> <p><b>NEW</b></p> <p>TOYO-41.P</p> <p>7,8</p> <p>2,95</p> <p>TOYO-18.P</p> <p>FOR: LEXUS® - MAZDA® FOR: TOYOTA® FOR: TOKAJ® - RIKKA®</p>	 <p><b>NEW</b></p> <p>TOYO-40</p>	 <p><b>NEW</b></p> <p>TOYO-40D</p>	 <p><b>NEW</b></p> <p>TRL-3</p>	 <p><b>NEW</b></p> <p>TRL-3D</p>	 <p>LAT.</p> <p><b>NEW</b></p> <p>TRL-4.P</p> <p>8</p> <p>2,95</p>

FOR: TRELOCK®	FOR: TRIUMPH MOT.®	FOR: TRW-SIPEA®	FOR: VACHETTE®
 <p><b>NEW</b></p> <p>TRL-5.P</p>	 <p>LAT.</p> <p><b>NEW</b></p> <p>TRP-2</p> <p>6,5</p> <p>2,2</p>	 <p>ALP.</p> <p><b>NEW</b></p> <p>FI-16C3</p> <p>7,6</p> <p>3</p>	 <p>ALP.</p> <p><b>NEW</b></p> <p>VA-61C3</p> <p>....A/Z 0/9 1-4092 ....A/Z 0/9 5001-9092 ....A/Z 0/9 1-4092 ....A/Z 0/9 5001-9092</p>

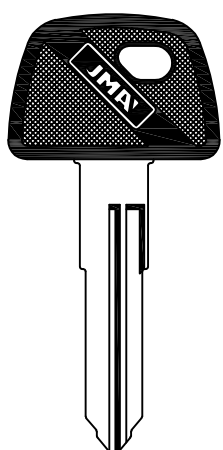
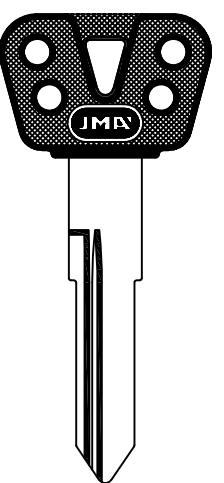
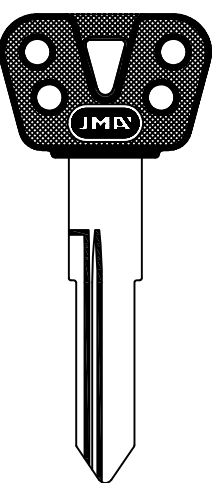
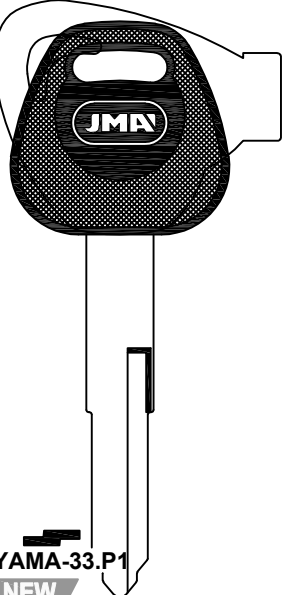
FOR: VALEO®	FOR: YAMAHA®			
 <p>ALP.</p> <p>.....1-2-3-4-Q-5-6-7-8-H .....A-B-C-D-E-F</p> <p><b>NEW</b></p> <p>CIT-1C1</p> <p>FOR: CITROEN®</p> <p>7</p> <p>3</p>	 <p><b>NEW</b></p> <p>YAMA-25.P</p> <p>FOR: PUCH® - VESPA® - YAMAHA®</p>	 <p>..... 6001-7000</p> <p><b>NEW</b></p> <p>YAMA-25D.P</p>	 <p><b>NEW</b></p> <p>YAMA-32D.P</p>	 <p><b>NEW</b></p> <p>YAMA-33.P1</p>





FOR: YAMAHA®

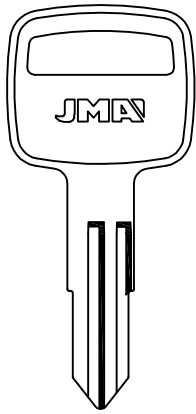

  
YAMA-34  
NEW

  
YAMA-34D  
NEW

FOR: ZADI®

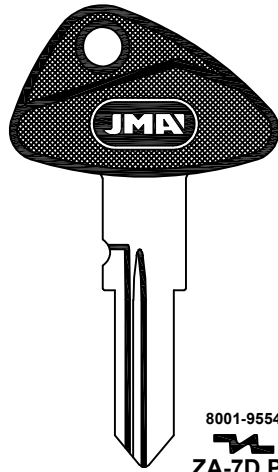

8001-9554  
  
ZA-7D.P1

NEW

8001-9554  
  
ZA-6D.P  
FOR: BMW®

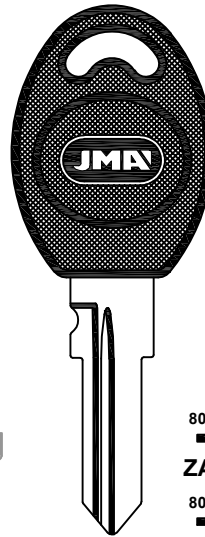

8001-9554  
  
ZA-9.P2

NEW

8001-9554  
  
ZA-6D.P1  
FOR: APRILIA® - BETA®

FOR:  
YAMAHA® (J)  
ZADI® (I)





**LLAVES DE CRUZ-GORJA-ARMARIO**  
GURUTZE-GORJA-ARMAIRUETARAKO GILTZA  
CRUCIFORM- BIT -FURNITURE KEYS  
CLÉS CRUCIFORMES-GORGES- POUR MEUBLES  
KREUTZSCHLÜSSEL-CHUBBSCHLÜSSEL-MOBELSCHÜSSEL

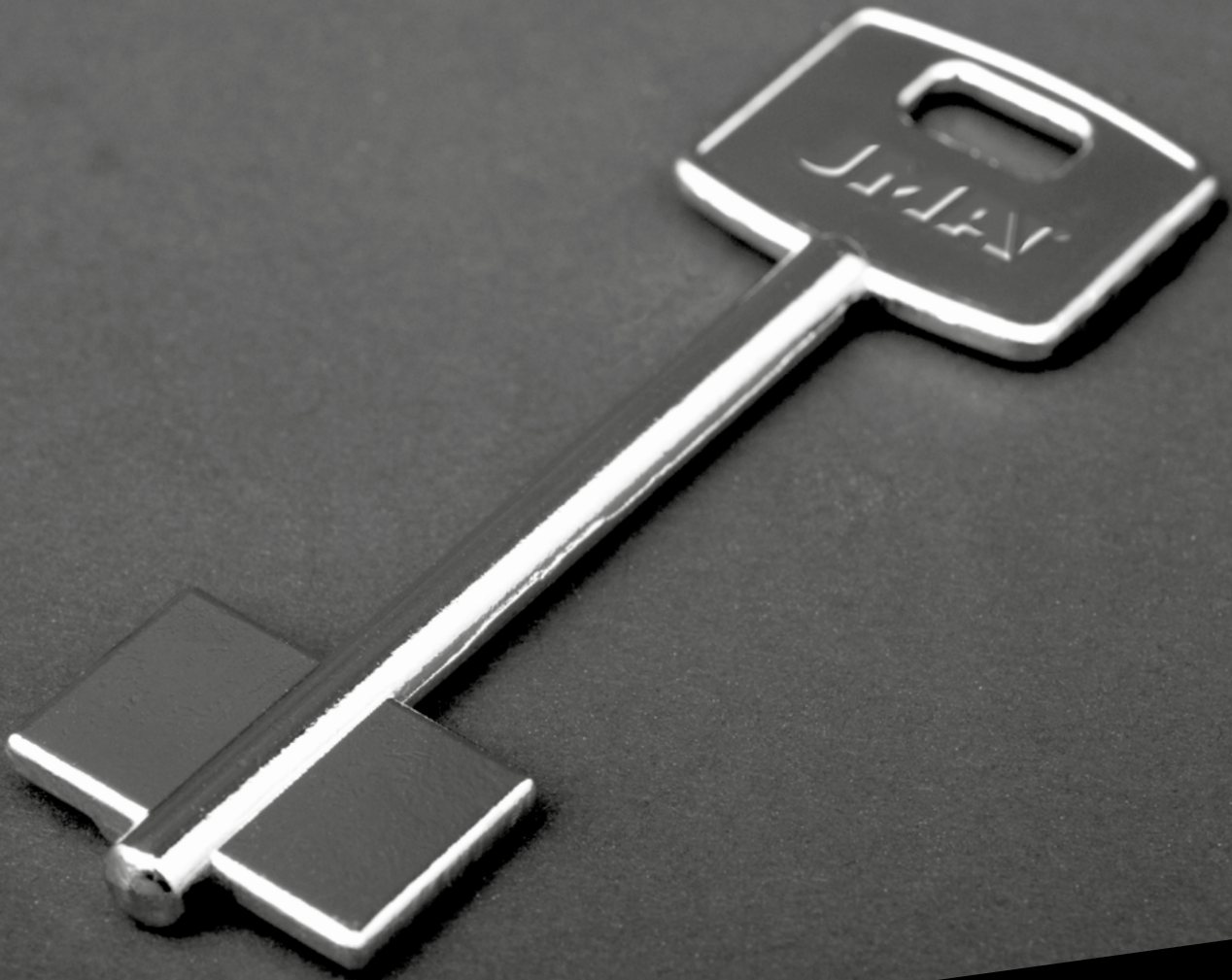

**SUPLEMENTO-SUPPLEMENT**  
**C11.2021**

**THE KEY TO EXCELLENCE**  
GLOBALLY UNLOCKING MILLIONS OF DOORS DAILY

**FOR:**  
 101® (P)  
 716® (P)  
 BRICARD® (F)  
 CLASS® (RUS)

**FOR: 101®**

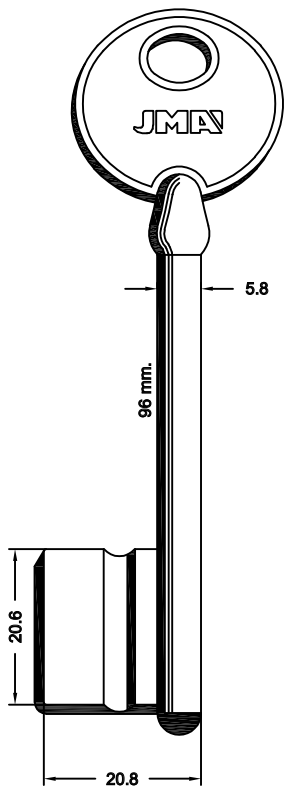

**FOR: 716®**

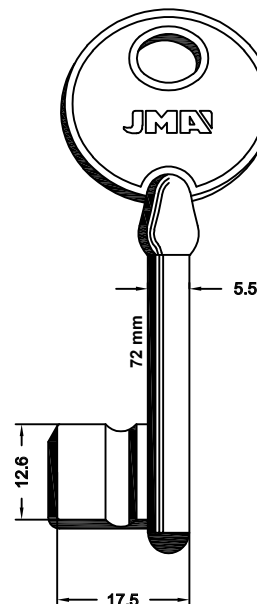

**FOR: BRICARD®**

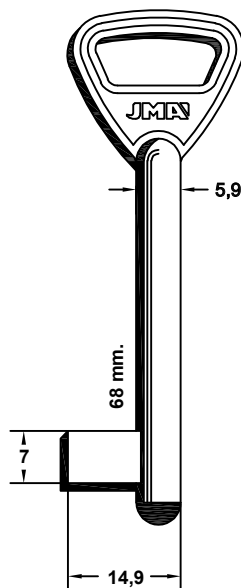
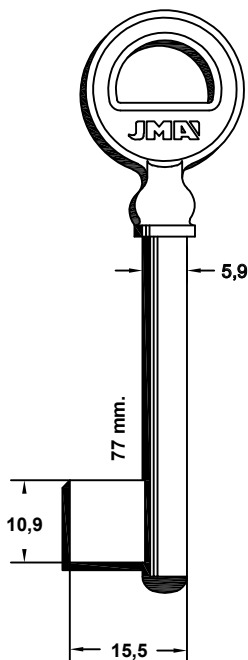
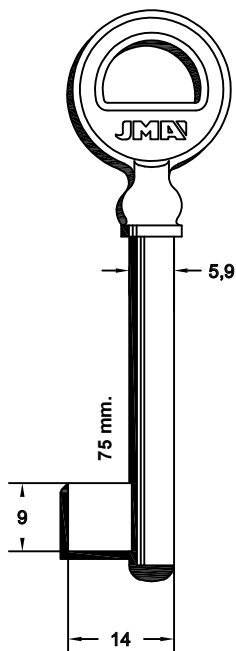

**FOR: CLASS®**

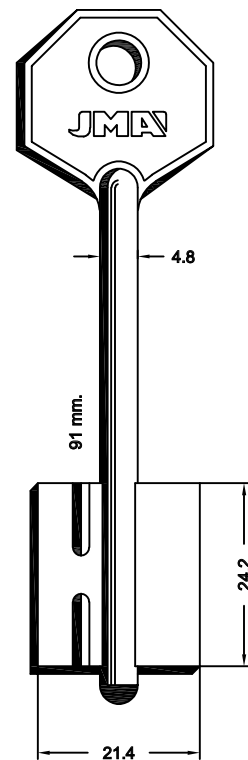

FOR: CLASS®

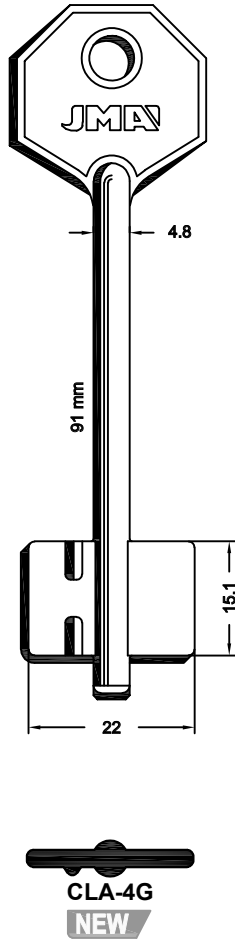
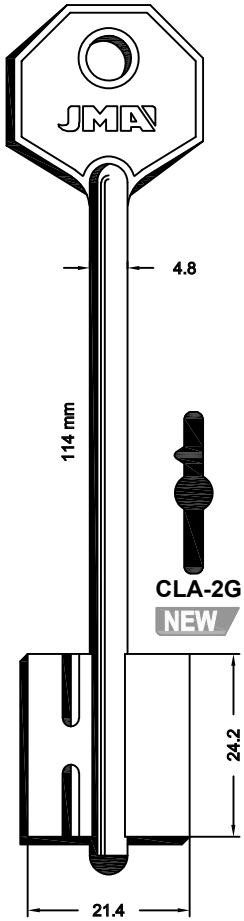

FOR: DEBERAURAIN-ND®

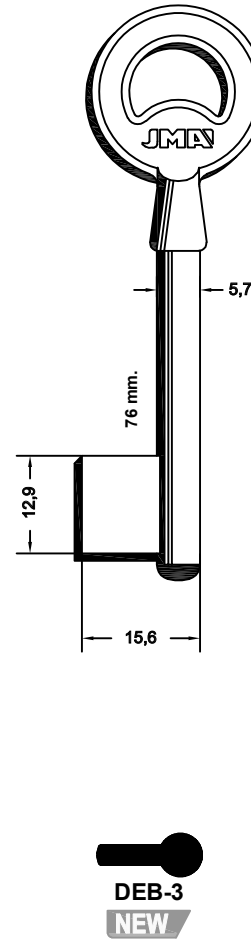
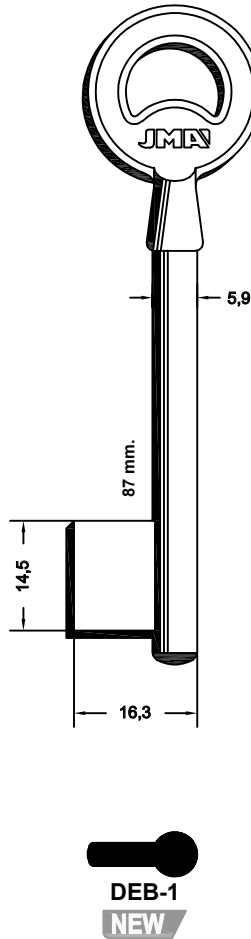

FOR:  
 CLASS® (RUS)  
 DEBERAURAIN  
 ND(F)  
 DENY® (F)  
 ELBOR® (RUS)  
 EUROSPEC®  
 (GB)

FOR: DENY®

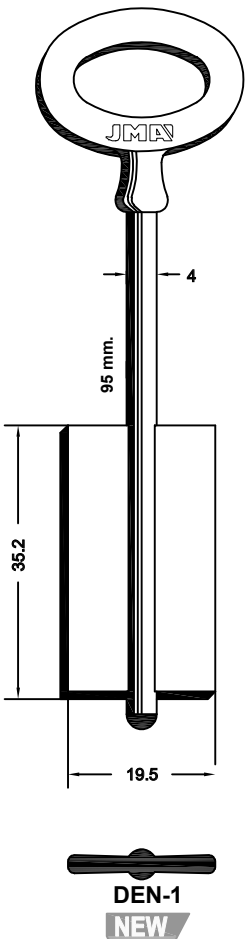

FOR: ELBOR®

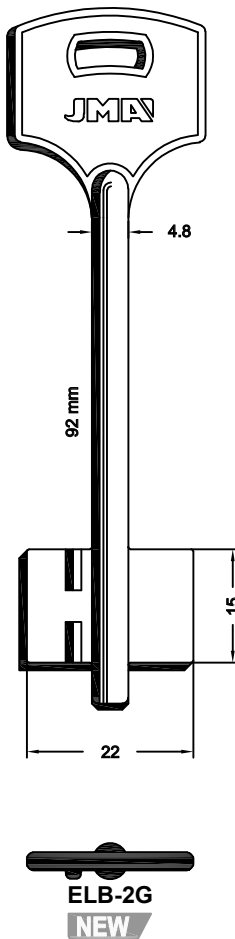

FOR: EUROSPEC®

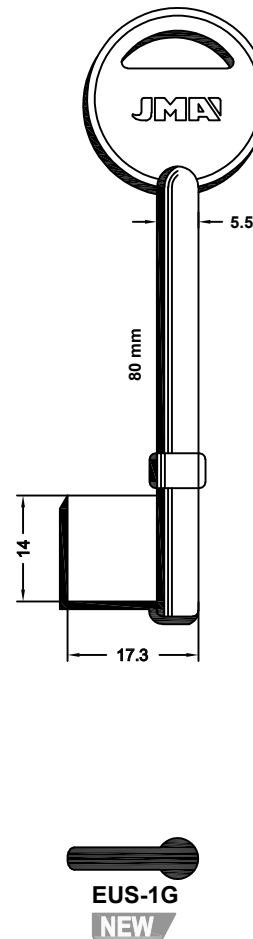
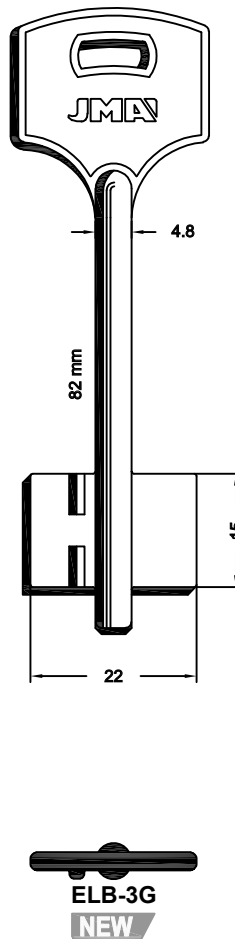

**FOR:**  
 EZCURRA® (E)  
 FAS® (S)  
 FICHET® (F)  
 GARDIAN®  
 (RUS)  
 GERION® (RUS)

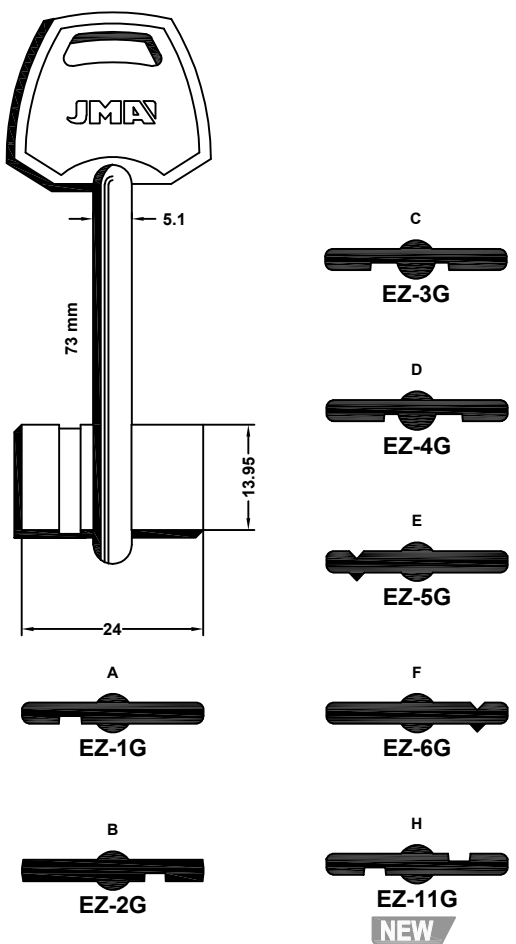
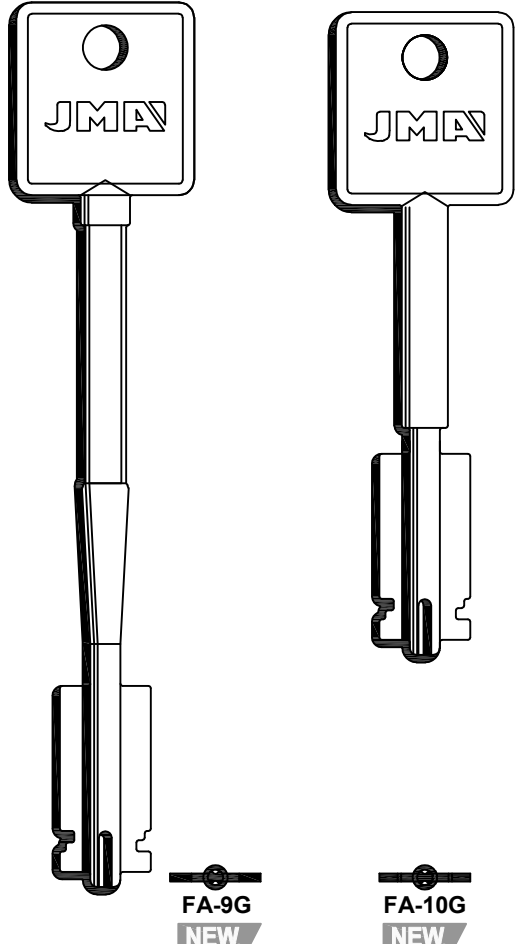
FOR: EZCURRA®		FOR: FAS®	
			

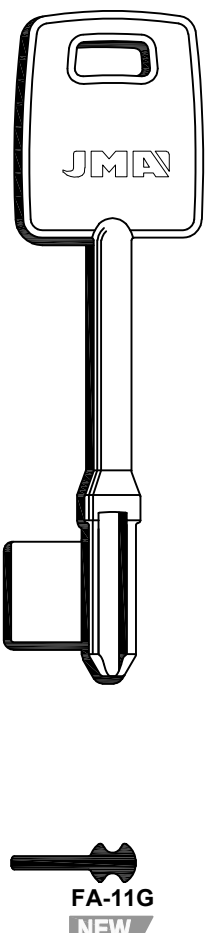
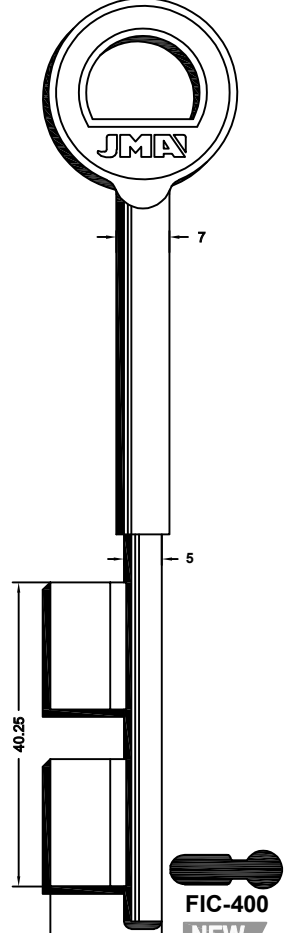
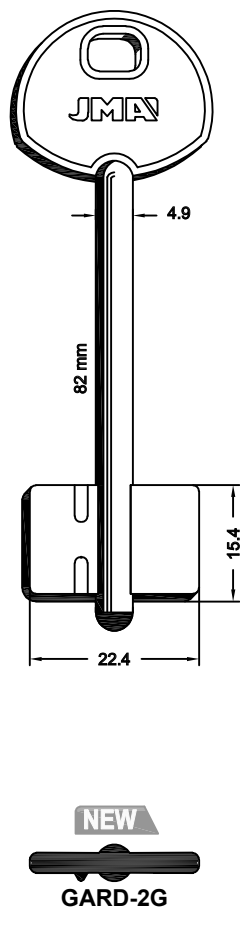
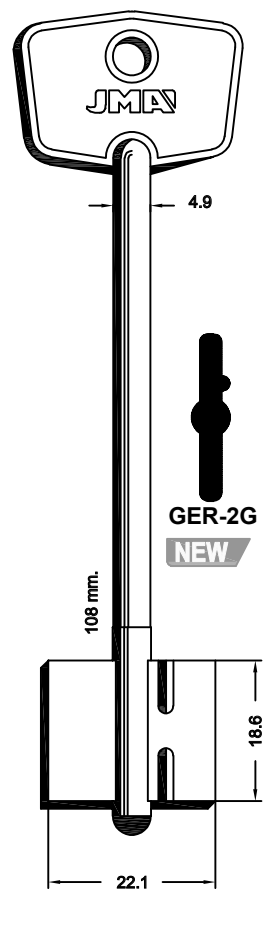
FOR: FAS®	FOR: FICHET®	FOR: GARDIAN®	FOR: GERION®
			



FOR: GERION®

FOR: HOBES®

FOR:

GERION® (RUS)

HOBES® (PL)

JPM® (F)

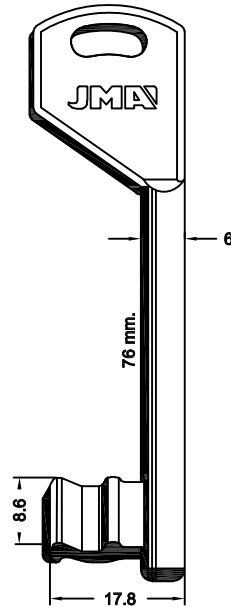
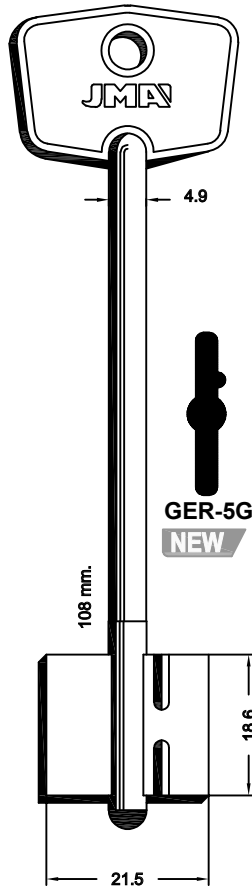
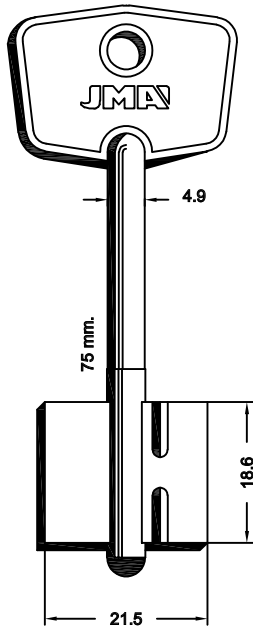
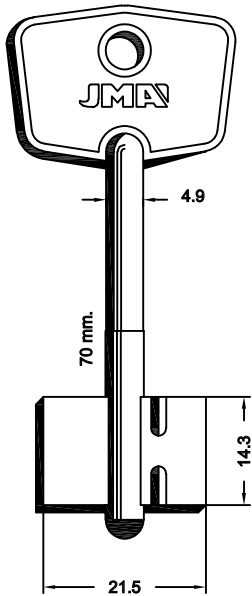

FOR: JPM®

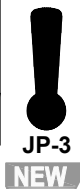
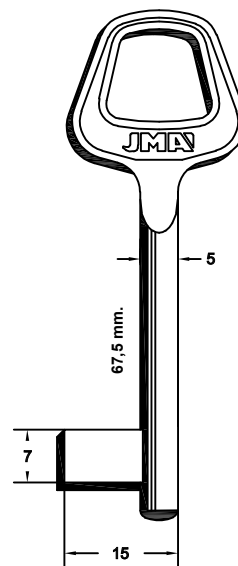
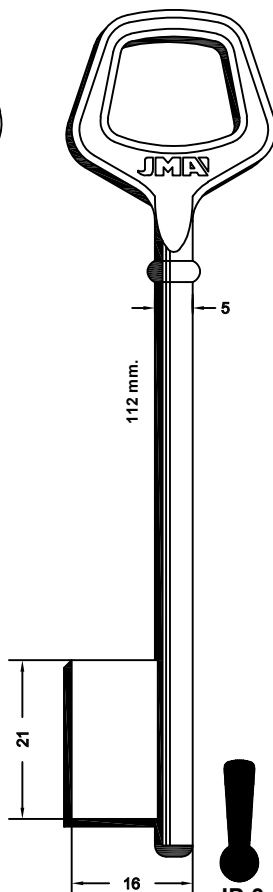
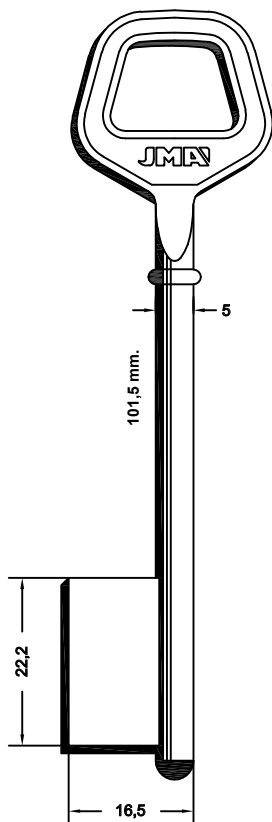
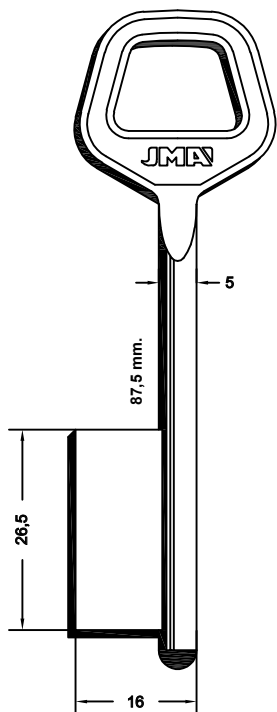

FOR:

- JPM® (F)
- LAPERCHE® (F)
- MAFOR® (F)
- MOIA® (I)
- MOTTURA® (I)

FOR: JPM®

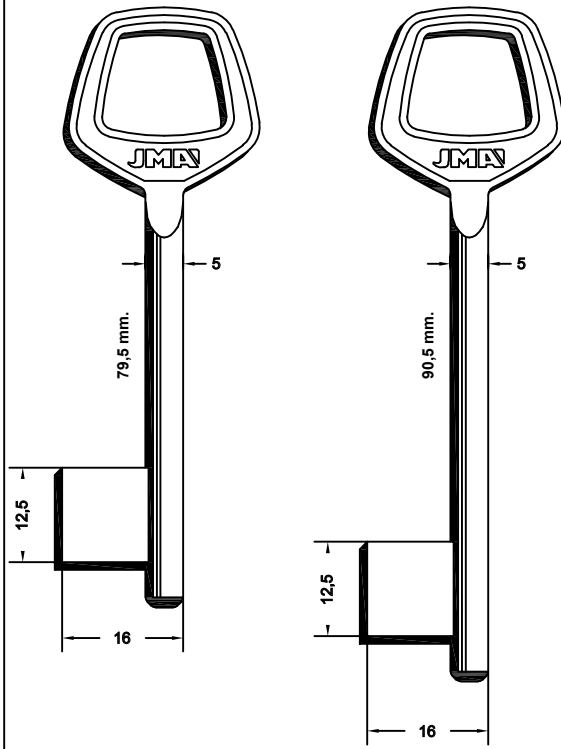

FOR: LAPERCHE®

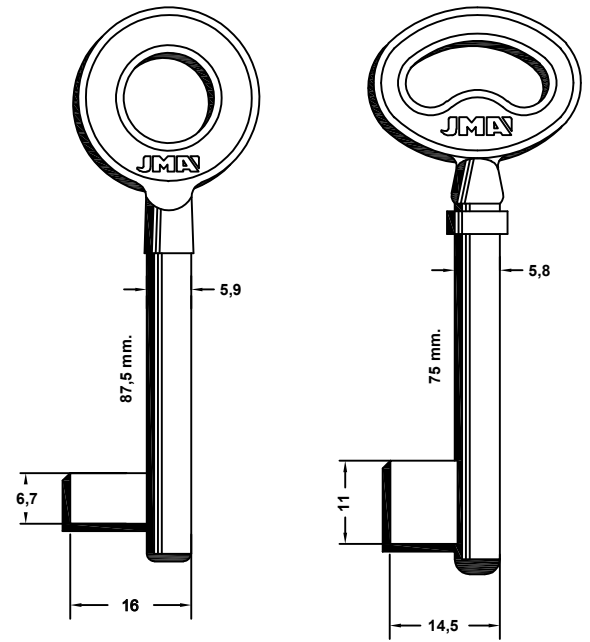

FOR: MAFOR®

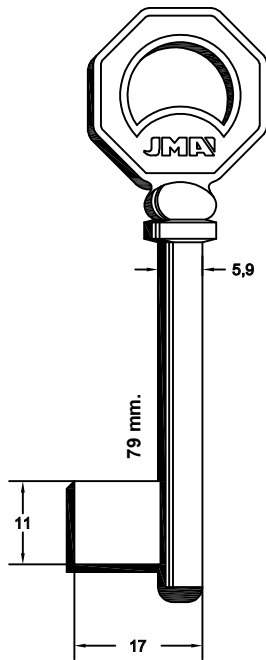

FOR: MOIA®

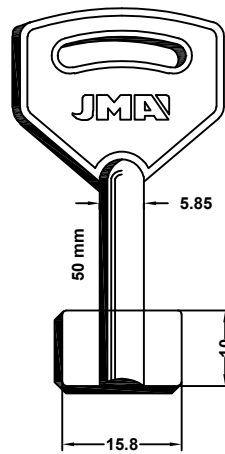

FOR: O.M.R.®

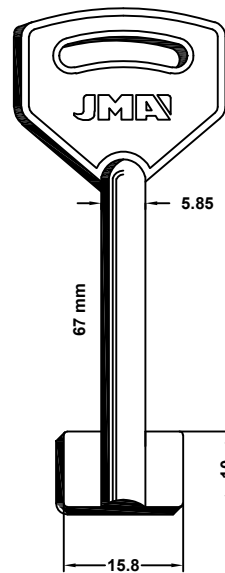

FOR: O.M.R.®

FOR: MOTTURA®

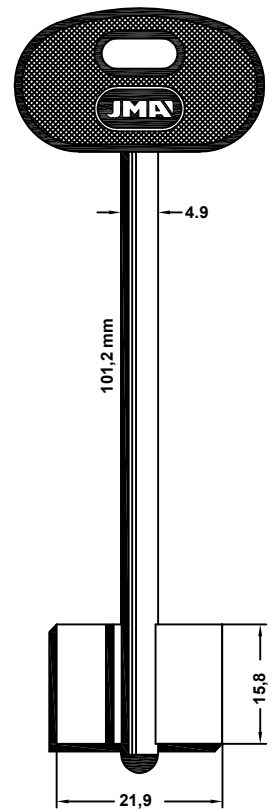

**JMA**®

Copyright by Alejandro Altuna S.L.U. 2021



ATENCIÓN: Concerniente a las marcas y denominaciones comerciales ver nota en índice.  
 ATTENTION: Concerning the marks and commercial denominations see note in index.  
 ATTENTION: Concernant les marques et dénominations commerciales voir la note dans l'index.  
 ACHTUNG: Beziehen auf die marke und handelsname sehen sie die notiz im index.



FOR: POTENT®

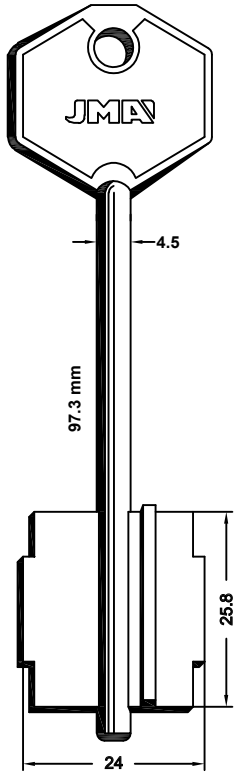

FOR: SELECT®

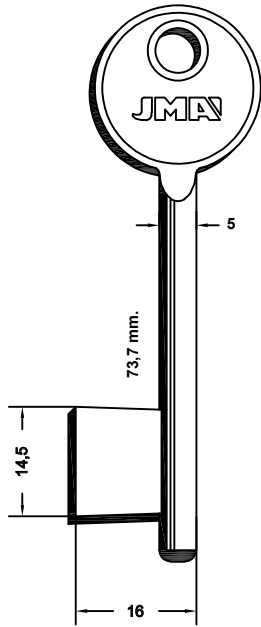

FOR: VACHETTE®

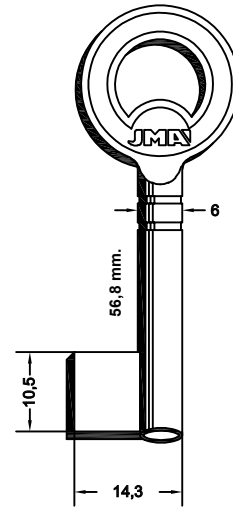
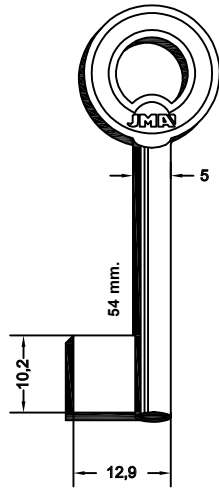

FOR:  
POTENT® (I)  
SELECT® (F)  
VACHETTE® (F)

FOR: VACHETTE®

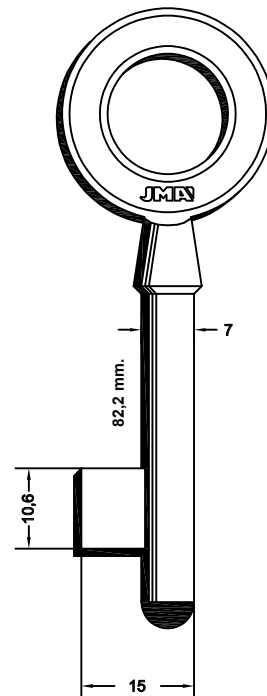
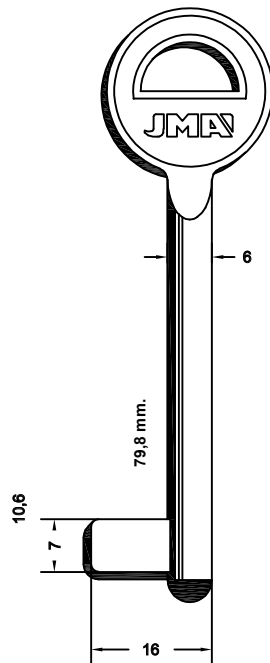
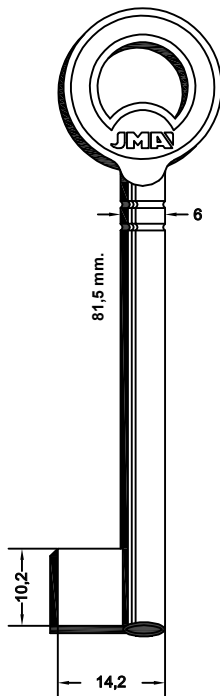
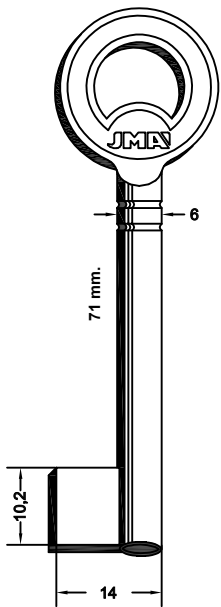



***ESPECIALISTA***

***SPECIALIST***

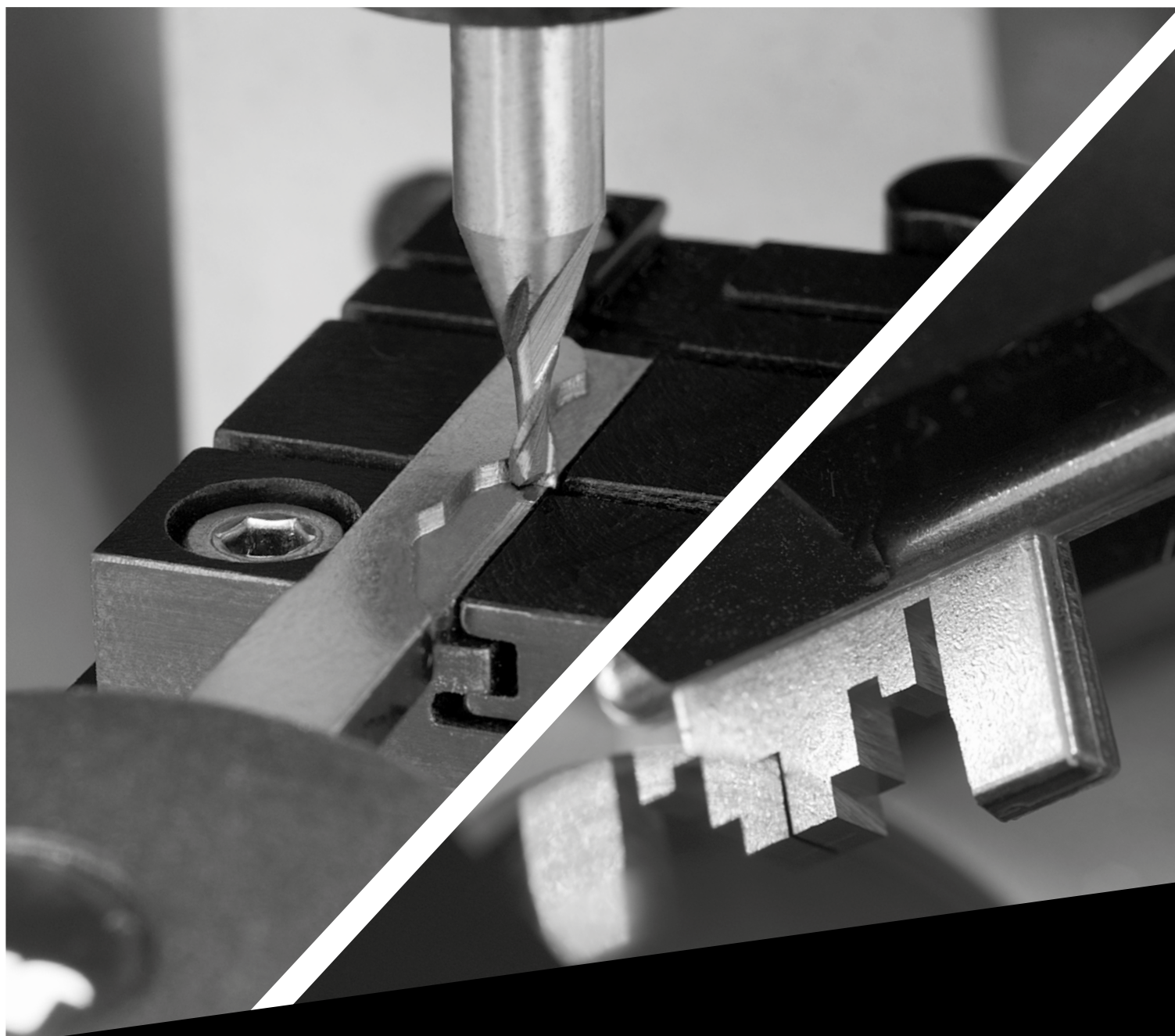

***SUPLEMENTO-SUPPLEMENT***

***C11.2021***

***THE KEY TO EXCELLENCE***  
GLOBALLY UNLOCKING MILLIONS OF DOORS DAILY

## MAQUINAS - MACHINES



**CAPRI**



**CAPRISMART**



**NEO**



**MULTICODE**



**X-CODE**

## FRESAS - CUTTERS

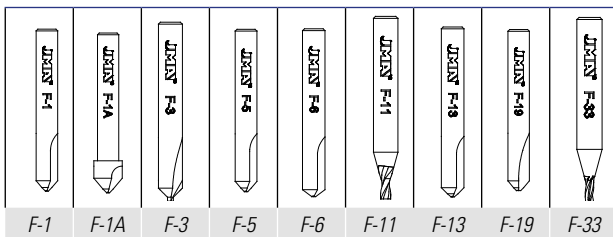

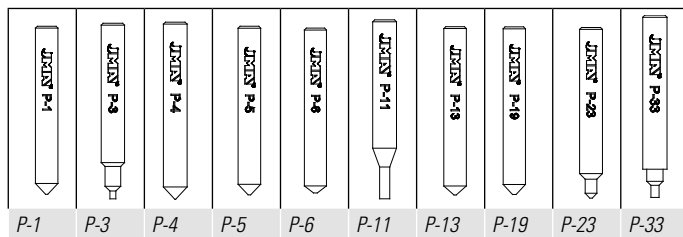

## PALPADORES-TRACERS

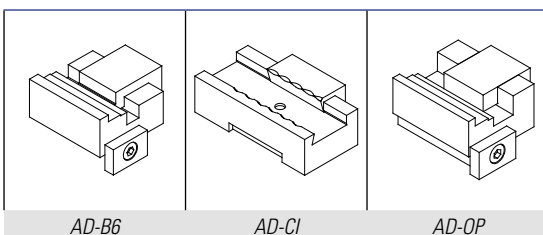

## ADAPTADORES - ADAPTORS









FOR:	JMA®				
<b>ABUS®</b>	ABU-91	CAPRI	F-1	P-1	AD-CI
	ABU-91	CAPRI S.	F-1	P-1	AD-CI
	ABU-91	NEO-DAKKI	F-1	P-1	AD-CI
	ABU-96	CAPRI	F-1	P-1	AD-CI
	ABU-96	CAPRI S.	F-1	P-1	AD-CI
	ABU-96	NEO-DAKKI	F-1	P-1	AD-CI
	ABU-102	CAPRI	F-1	P-1	AD-CI
	ABU-102	CAPRI S.	F-1	P-1	AD-CI
	ABU-102	NEO-DAKKI	F-1	P-1	AD-CI
<b>AGA®</b>	AGA-55D	CAPRI	F-1	P-1	
	AGA-55D	CAPRI S.	F-1	P-1	
	AGA-55D	NEO-DAKKI	F-1	P-1	
<b>AGB®</b>	AGB-6	CAPRI	F-1	P-1	
	AGB-6	CAPRI S.	F-1	P-1	
	AGB-6	NEO-DAKKI	F-1	P-1	
	AGB-7	CAPRI	F-1	P-1	
	AGB-7	CAPRI S.	F-1	P-1	
	AGB-7	NEO-DAKKI	F-1	P-1	
<b>AMIG®</b>	AMG-11D	CAPRI	F-19	P-19	
	AMG-11D	CAPRI S.	F-19	P-19	
	AMG-11D	NEO-DAKKI	F-19	P-19	
	AMG-12D	CAPRI	F-19	P-19	
	AMG-12D	CAPRI S.	F-19	P-19	
	AMG-12D	NEO-DAKKI	F-19	P-19	
<b>ANBO®</b>	ANB-1	CAPRI	F-1	P-1	AD-CI
	ANB-1	CAPRI S.	F-1	P-1	AD-CI
	ANB-1	NEO-DAKKI	F-1	P-1	AD-CI
<b>ATLAS®</b>	ATL-1	CAPRI	F-1	P-1	
	ATL-1	CAPRI S.	F-1	P-1	
	ATL-1	NEO-DAKKI	F-1	P-1	
<b>AXA®</b>	AX-5DP1	CAPRI	F-33	P-33	
	AX-5DP1	CAPRI S.	F-33	P-33	
	AX-5DP1	NEO-DAKKI	F-33	P-33	
	AX-5DP1	XCODE	F-33		
	AX-6	CAPRI	F-1	P-23	
	AX-6	CAPRI S.	F-1	P-23	
	AX-6	NEO-DAKKI	F-1	P-23	
<b>BRISANT®</b>	BRN-1D	CAPRI	F-19	P-19	
	BRN-1D	CAPRI S.	F-19	P-19	
	BRN-1D	NEO-DAKKI	F-19	P-19	
	BRN-2D	CAPRI	F-19	P-19	
	BRN-2D	CAPRI S.	F-19	P-19	





FOR:	JMA®				
<b>BRISANT®</b>	BRN-2D	NEO-DAKKI	F-19	P-19	
<b>BURG®</b>	BUR-41	NEO-DAKKI	F-1	P-1	
	BUR-41	CAPRI S.	F-1	P-1	
	BUR-41	CAPRI	F-1	P-1	
	BUR-43	NEO-DAKKI	F-1	P-1	
	BUR-43	CAPRI S.	F-1	P-1	
	BUR-43	CAPRI	F-1	P-1	
<b>CISA®</b>	CI-48P	CAPRI	F-1	P-1	AD-CI
	CI-48P	CAPRI S.	F-1	P-1	AD-CI
	CI-48P	NEO-DAKKI	F-1	P-1	AD-CI
	CI-71P	CAPRI	F-1	P-1	AD-CI
	CI-71P	CAPRI S.	F-1	P-1	AD-CI
	CI-71P	NEO-DAKKI	F-1	P-1	AD-CI
	CI-72P	CAPRI	F-1	P-1	AD-CI
	CI-72P	CAPRI S.	F-1	P-1	AD-CI
	CI-72P	NEO-DAKKI	F-1	P-1	AD-CI
	CI-73P	CAPRI	F-1	P-1	AD-CI
	CI-73P	CAPRI S.	F-1	P-1	AD-CI
	CI-73P	NEO-DAKKI	F-1	P-1	AD-CI
	CI-75P	CAPRI	F-1	P-1	AD-CI
	CI-75P	CAPRI S.	F-1	P-1	AD-CI
	CI-75P	NEO-DAKKI	F-1	P-1	AD-CI
	CI-76P	CAPRI	F-1	P-1	AD-CI
	CI-76P	CAPRI S.	F-1	P-1	AD-CI
	CI-76P	NEO-DAKKI	F-1	P-1	AD-CI
	CI-77P	CAPRI	F-1	P-1	AD-CI
	CI-77P	CAPRI S.	F-1	P-1	AD-CI
	CI-77P	NEO-DAKKI	F-1	P-1	AD-CI
CI-78P	CAPRI	F-1	P-1	AD-CI	
CI-78P	CAPRI S.	F-1	P-1	AD-CI	
CI-78P	NEO-DAKKI	F-1	P-1	AD-CI	
CI-79P	CAPRI	F-1	P-1	AD-CI	
CI-79P	CAPRI S.	F-1	P-1	AD-CI	
CI-79P	NEO-DAKKI	F-1	P-1	AD-CI	
CI-80P	CAPRI	F-1	P-1	AD-CI	
CI-80P	CAPRI S.	F-1	P-1	AD-CI	
CI-80P	NEO-DAKKI	F-1	P-1	AD-CI	
CI-81	CAPRI	F-1	P-1	AD-CI	
CI-81	CAPRI S.	F-1	P-1	AD-CI	
CI-81	NEO-DAKKI	F-1	P-1	AD-CI	
CI-81P	CAPRI	F-1	P-1	AD-CI	



FOR:	JMA®				
<b>CISA®</b>	CI-81P	CAPRI S.	F-1	P-1	AD-CI
	CI-81P	NEO-DAKKI	F-1	P-1	AD-CI
	CI-82P	CAPRI	F-1	P-1	AD-CI
	CI-82P	CAPRI S.	F-1	P-1	AD-CI
	CI-82P	NEO-DAKKI	F-1	P-1	AD-CI
	CI-83P	CAPRI	F-1	P-1	AD-CI
	CI-83P	CAPRI S.	F-1	P-1	AD-CI
	CI-83P	NEO-DAKKI	F-1	P-1	AD-CI
	CI-84P	CAPRI	F-1	P-1	AD-CI
	CI-84P	CAPRI S.	F-1	P-1	AD-CI
CI-84P	NEO-DAKKI	F-1	P-1	AD-CI	
<b>DEKABA®</b>	DEK-16	CAPRI	F-1	P-1	
	DEK-16	CAPRI S.	F-1	P-1	
	DEK-16	NEO-DAKKI	F-1	P-1	
	DEK-17	CAPRI	F-1	P-1	
	DEK-17	CAPRI S.	F-1	P-1	
	DEK-17	NEO-DAKKI	F-1	P-1	
<b>DELTA®</b>	DLT-1D	CAPRI	F-5	P-5	
	DLT-1D	CAPRI S.	F-5	P-5	
	DLT-1D	NEO-DAKKI	F-5	P-5	
<b>DIERRE®</b>	DR-2D	CAPRI	F-13	P-13	
	DR-2D	CAPRI S.	F-13	P-13	
	DR-2D	NEO-DAKKI	F-13	P-13	
<b>DOM®</b>	DOM-B2	CAPRI	F-1	P-1	
	DOM-B2	CAPRI S.	F-1	P-1	
	DOM-B2	NEO-DAKKI	F-1	P-1	
	DOM-B6	CAPRI	F-1A	P-23	AD-B6
	DOM-B6	CAPRI S.	F-1A	P-23	AD-B6
	DOM-B6	NEO-DAKKI	F-1A	P-23	AD-B6
<b>ELZETT®</b>	ELZ-13	CAPRI	F-5	P-5	
	ELZ-13	NEO-DAKKI	F-5	P-5	
	ELZ-13	CAPRI S.	F-5	P-5	
<b>EUROLOCKS®</b>	EU-15P	CAPRI	F-33	P-33	
	EU-15P	NEO-DAKKI	F-33	P-33	
	EU-15P	CAPRI S.	F-33	P-33	
	EU-16DP	CAPRI	F-33	P-33	
	EU-16DP	NEO-DAKKI	F-33	P-33	
	EU-16DP	CAPRI S.	F-33	P-33	
<b>EVERLEO®</b>	EVR-1	CAPRI	F-5	P-5	
	EVR-2	NEO-DAKKI	F-5	P-5	
	EVR-3	CAPRI S.	F-5	P-5	

FOR:	JMA®				
<b>EZCURRA®</b>	EZ-DS15R WINDCOLOR	CAPRI	F-1	P-1	
	EZ-DS15R WINDCOLOR		F-16	P-16	
	EZ-DS15R WINDCOLOR	CAPRI S.	F-1	P-1	
	EZ-DS15R WINDCOLOR		F-16	P-16	
	EZ-DS15R WINDCOLOR	NEO-DAKKI	F-1	P-1	
	EZ-DS15R WINDCOLOR		F-16	P-16	
	EZ-DS15R WINDCOLOR		F-16	P-16	
<b>FAC®</b>	FAC-25	CAPRI	F-1	P-1	
	FAC-25	CAPRI S.	F-1	P-1	
	FAC-25	NEO-DAKKI	F-1	P-1	
<b>FCV®</b>	FV-3	CAPRI	F-5	P-5	
	FV-3	CAPRI S.	F-5	P-5	
	FV-3	NEO-DAKKI	F-5	P-5	
<b>FTH®</b>	FTH-30	CAPRI	F-5	P-5	
	FTH-30	CAPRI S.	F-5	P-5	
	FTH-30	NEO-DAKKI	F-5	P-5	
<b>FERONERIA®</b>	FER-2D	CAPRI	F-19	P-19	
	FER-2D	CAPRI S.	F-19	P-19	
	FER-2D	NEO-DAKKI	F-19	P-19	
<b>FORD®</b>	FO-24C3	CAPRI	F-11	P-11	
	FO-24C3	CAPRI S.	F-11	P-11	
	FO-24C3	NEO-DAKKI	F-11	P-11	
	FO-24C8	CAPRI	F-11	P-11	
	FO-24C8	CAPRI S.	F-11	P-11	
	FO-24C8	NEO-DAKKI	F-11	P-11	
	FO-24C9	CAPRI	F-11	P-11	
	FO-24C9	CAPRI S.	F-11	P-11	
	FO-24C9	NEO-DAKKI	F-11	P-11	
<b>GERDA®</b>	GDA-4D	CAPRI	F-1	P-1	
	GDA-4D	CAPRI S.	F-1	P-1	
	GDA-4D	NEO-DAKKI	F-1	P-1	
	GDA-5	CAPRI	F-11	P-11	AD-OP
	GDA-5	CAPRI S.	F-11	P-11	AD-OP
<b>GEVY®</b>	GEV-3D	CAPRI	F-1	P-1	
	GEV-3D	CAPRI S.	F-1	P-1	
	GEV-3D	NEO-DAKKI	F-1	P-1	
<b>HOK®</b>	HOK-1D	CAPRI	F-5	P-5	
	HOK-1D	CAPRI S.	F-5	P-5	
	HOK-1D	NEO-DAKKI	F-5	P-5	

FOR:	JMA				
<b>HUF</b> ®	HU-4C1	CAPRI	F-3	P-3	
	HU-4C1	CAPRI S.	F-3	P-3	
	HU-4C1	NEO-DAKKI	F-3	P-3	
	HU-7C1	CAPRI	F-3	P-3	
	HU-7C1	CAPRI S.	F-3	P-3	
	HU-7C1	NEO-DAKKI	F-3	P-3	
	HU-HCAP	CAPRI	F-11	P-11	
	HU-HCAP	CAPRI S.	F-11	P-11	
	HU-HCAP	NEO-DAKKI	F-11	P-11	
	OP-11C3	CAPRI	F-11	P-11	
	OP-11C3	CAPRI S.	F-11	P-11	
	OP-11C3	NEO-DAKKI	F-11	P-11	
	<b>HUGO</b> ®	HGO-2D	CAPRI	F-1	P-1
HGO-2D		CAPRI S.	F-1	P-1	
HGO-2D		NEO-DAKKI	F-1	P-1	
<b>HYUNDAI</b> ®	HY-18P1C1	CAPRI	F-11	P-11	
	HY-18P1C1	CAPRI S.	F-11	P-11	
	HY-18P1C1	NEO-DAKKI	F-11	P-11	
	HY-19P5	CAPRI	F-11	P-11	
	HY-19P5	CAPRI S.	F-11	P-11	
	HY-19P5	NEO-DAKKI	F-11	P-11	
	HY-19DP5	CAPRI	F-11	P-11	
	HY-19DP5	CAPRI S.	F-11	P-11	
	HY-19DP5	NEO-DAKKI	F-11	P-11	
	HY-20P	CAPRI	F-11	P-11	
	HY-20P	CAPRI S.	F-11	P-11	
	HY-20P	NEO-DAKKI	F-11	P-11	
	<b>IFAM</b> ®	IF-8	CAPRI	F-19	P-19
IF-8		CAPRI S.	F-19	P-19	
IF-8		NEO-DAKKI	F-19	P-19	
IF-9		CAPRI	F-19	P-19	
IF-9		CAPRI S.	F-19	P-19	
IF-9		NEO-DAKKI	F-19	P-19	
<b>ITO</b> ®		ITO-3D	CAPRI	F-1	P-1
	ITO-3D	CAPRI S.	F-1	P-1	
	ITO-3D	NEO-DAKKI	F-1	P-1	
<b>KABA</b> ®	KA-7 WIND-COLOR	CAPRI	F-1	P-1	
	KA-7 WIND-COLOR	CAPRI S.	F-1	P-1	
	KA-7 WIND-COLOR	NEO-DAKKI	F-1	P-1	
<b>KALE</b> ®	KAE-15D	CAPRI	F-1	P-1	
	KAE-15D	CAPRI S.	F-1	P-1	

FOR:	JMA				
<b>KESO</b> ®	KAE-15D	NEO-DAKKI	F-1	P-1	
	KE-6	CAPRI	F-5	P-5	
	KE-6		F-S31	PS31	
	KE-6	CAPRI S.	F-5	P-5	
	KE-6		F-S31	PS31	
	KE-6	NEO-DAKKI	F-5	P-5	
	KE-6		F-S31	PS31	
	KE-7	CAPRI	F-5	P-5	
	KE-7		F-S31	PS31	
	KE-7	CAPRI S.	F-5	P-5	
	KE-7		F-S31	PS31	
	KE-7	NEO-DAKKI	F-5	P-5	
	KE-7		F-S31	PS31	
<b>KAWASAKI</b> ®	KM-1P	CAPRI	F-11	P-11	
	KM-1P	CAPRI S.	F-11	P-11	
	KM-1P	NEO-DAKKI	F-11	P-11	
<b>KIA</b> ®	KI-11P	CAPRI	F-11	P-11	
	KI-11P	CAPRI S.	F-11	P-11	
	KI-11P	NEO-DAKKI	F-11	P-11	
	KI-12P	CAPRI	F-11	P-11	
	KI-12P	CAPRI S.	F-11	P-11	
	KI-12P	NEO-DAKKI	F-11	P-11	
	KI-12DP	CAPRI	F-11	P-11	
	KI-12DP	CAPRI S.	F-11	P-11	
	KI-12DP	NEO-DAKKI	F-11	P-11	
<b>LINCE</b> ®	LIN-21D WINDCOLOR	CAPRI	F-5	P-5	
	LIN-21D WINDCOLOR	CAPRI S.	F-5	P-5	
	LIN-21D WINDCOLOR	NEO-DAKKI	F-5	P-5	
	LIN-26D	CAPRI	F-5	P-5	
	LIN-26D	CAPRI S.	F-5	P-5	
	LIN-26D	NEO-DAKKI	F-5	P-5	
<b>MAUER</b> ®	MAU-1	CAPRI	F-1	P-1	
	MAU-1	CAPRI S.	F-1	P-1	
	MAU-1	NEO-DAKKI	F-1	P-1	
	MAU-2	CAPRI	F-1	P-1	
	MAU-2	CAPRI S.	F-1	P-1	
	MAU-2	NEO-DAKKI	F-1	P-1	
<b>MCM</b> ®	MCM-15E8	CAPRI	F-13	P-13	
	MCM-15E8	CAPRI S.	F-13	P-13	
	MCM-15E8	NEO-DAKKI	F-13	P-13	
	MCM-45	CAPRI	F-13	P-23	









FOR:	JMA®				
<b>MCM®</b>	MCM-45	CAPRI S.	F-13	P-23	
	MCM-45	NEO-DAKKI	F-13	P-23	
<b>MEGA®</b>	MEG-1D	CAPRI	F-5	P-5	
	MEG-1D	CAPRI S.	F-5	P-5	
	MEG-1D	NEO-DAKKI	F-5	P-5	
<b>MH®</b>	MH-1	CAPRI	F-5	P-5	
	MH-1	CAPRI S.	F-5	P-5	
	MH-1	NEO-DAKKI	F-5	P-5	
	MH-2D	CAPRI	F-5	P-5	
	MH-2D	CAPRI S.	F-5	P-5	
	MH-2D	NEO-DAKKI	F-5	P-5	
<b>MOTTURA®</b>	MT-1P	CAPRI	F-1	P-4	
	MT-1P	CAPRI S.	F-1	P-4	
	MT-1P	NEO-DAKKI	F-1	P-4	
	MT-2D	CAPRI	F-1	P-4	
	MT-2D	CAPRI S.	F-1	P-4	
	MT-2D	NEO-DAKKI	F-1	P-4	
	MT-2DP	CAPRI	F-1	P-4	
	MT-2DP	CAPRI S.	F-1	P-4	
	MT-2DP	NEO-DAKKI	F-1	P-4	
<b>NOORI®</b>	NOR-1	CAPRI	F-1	P-1	
	NOR-1	CAPRI S.	F-1	P-1	
	NOR-1	NEO-DAKKI	F-1	P-1	
<b>OJMAR®</b>	OJ-20/4	CAPRI	F-1	P-1	
	OJ-20/4	CAPRI S.	F-1	P-1	
	OJ-20/4	NEO-DAKKI	F-1	P-1	
<b>OMEC®</b>	OMC-7	CAPRI	F-1	P-1	
	OMC-7	CAPRI S.	F-1	P-1	
	OMC-7	NEO-DAKKI	F-1	P-1	
<b>POTENT®</b>	PTN-3D	CAPRI	F-19	P-19	
	PTN-3D	CAPRI S.	F-19	P-19	
	PTN-3D	NEO-DAKKI	F-19	P-19	
<b>PREFER®</b>	PR-21	CAPRI	F-13	P-13	
	PR-21	CAPRI S.	F-13	P-13	
	PR-21	NEO-DAKKI	F-13	P-13	
	PR-22	CAPRI	F-13	P-13	
	PR-22	CAPRI S.	F-13	P-13	
	PR-22	NEO-DAKKI	F-13	P-13	
<b>SEA®</b>	SEA-2	CAPRI	F-1	P-1	
	SEA-2	CAPRI	F-3	P-3	
	SEA-2	CAPRI S.	F-1	P-1	
	SEA-2	CAPRI S.	F-3	P-3	

FOR:	JMA®				
<b>SEA®</b>	SEA-2	NEO-DAKKI	F-1	P-1	
	SEA-2	NEO-DAKKI	F-3	P-3	
<b>SECUREMME®</b>	SEC-4DP	CAPRI	F-1	P-1	
	SEC-4DP	CAPRI S.	F-1	P-1	
	SEC-4DP	NEO-DAKKI	F-1	P-1	
<b>STANDERS®</b>	STN-1D	CAPRI	F-5	P-5	
	STN-1D	CAPRI S.	F-5	P-5	
	STN-1D	NEO-DAKKI	F-5	P-5	
<b>TECON®</b>	TC-3	CAPRI	F-5	P-5	
	TC-3	CAPRI S.	F-5	P-5	
	TC-3	NEO-DAKKI	F-5	P-5	
<b>TESA®</b>	TE-T60 WIN-DICOLOR	CAPRI	F-5	P-5	
	TE-T60 WIN-DICOLOR	CAPRI S.	F-5	P-5	
	TE-T60 WIN-DICOLOR	NEO-DAKKI	F-5	P-5	
	TE-T80EH	CAPRI	F-5	P-5	
	TE-T80EH	CAPRI S.	F-5	P-5	
	TE-T80EH	NEO-DAKKI	F-5	P-5	
<b>TITAN®</b>	TIT-21	CAPRI	F-19	P-19	
	TIT-21	CAPRI S.	F-19	P-19	
	TIT-21	NEO-DAKKI	F-19	P-19	
	TIT-22	CAPRI	F-19	P-19	
	TIT-22	CAPRI S.	F-19	P-19	
	TIT-22	NEO-DAKKI	F-19	P-19	
	TIT-23	CAPRI	F-19	P-19	
	TIT-23	CAPRI S.	F-19	P-19	
	TIT-23	NEO-DAKKI	F-19	P-19	
	TIT-26	CAPRI	F-19	P-19	
	TIT-26	CAPRI S.	F-19	P-19	
	TIT-26	NEO-DAKKI	F-19	P-19	
TIT-27	CAPRI	F-19	P-19		
TIT-27	CAPRI S.	F-19	P-19		
TIT-27	NEO-DAKKI	F-19	P-19		
<b>TOYOTA®</b>	TOYO-41P	CAPRI	F-11	P-11	
	TOYO-41P	CAPRI S.	F-11	P-11	
	TOYO-41P	NEO-DAKKI	F-11	P-11	
<b>TOVER®</b>	TOV-8D	CAPRI	F-1	P-1	
	TOV-8D	CAPRI S.	F-1	P-1	
	TOV-8D	NEO-DAKKI	F-1	P-1	
<b>TRELOCK®</b>	TRL-4P	CAPRI	F-11	P-11	
	TRL-4P	CAPRI S.	F-11	P-11	



# SEGURIDAD

## SECURITY

FOR:	JMA					FOR:	JMA				
<b>TRW-SIPEA®</b>	FI-16C3	CAPRI	F-33	P-33		<b>YARDENI®</b>	YAR-4D	CAPRI	F-13	P-13	
	FI-16C3	CAPRI S.	F-33	P-33			YAR-4D	CAPRI S.	F-13	P-13	
	FI-16C3	NEO-DAKKI	F-33	P-33			YAR-4D	NEO-DAKKI	F-13	P-13	
<b>UCEM®</b>	UCEM-8D WINDCOLOR	CAPRI	F-13	P-13							
	UCEM-8D WINDCOLOR	CAPRI S.	F-13	P-13							
	UCEM-8D WINDCOLOR	NEO-DAKKI	F-13	P-13							
	UCEM-20D	CAPRI	F-6	P-6							
	UCEM-20D	CAPRI S.	F-6	P-6							
	UCEM-20D	NEO-DAKKI	F-6	P-6							
	UCEM-21	CAPRI	F-19	P-19							
	UCEM-21	CAPRI S.	F-19	P-19							
	UCEM-21	NEO-DAKKI	F-19	P-19							
	UCEM-22D	CAPRI	F-13	P-13							
	UCEM-22D	CAPRI S.	F-13	P-13							
UCEM-22D	NEO-DAKKI	F-13	P-13								
<b>VACHETTE®</b>	VA-91	CAPRI	F-1	P-1							
	VA-91	CAPRI S.	F-1	P-1							
	VA-91	NEO-DAKKI	F-1	P-1							
<b>VALEO®</b>	CIT-1C1	CAPRI	F-11	P-11							
	CIT-1C1	CAPRI S.	F-11	P-11							
	CIT-1C1	NEO-DAKKI	F-11	P-11							
<b>YALE®</b>	YA-280D	CAPRI	F-5	P-5							
	YA-280D	CAPRI S.	F-5	P-5							
	YA-280D	NEO-DAKKI	F-5	P-5							
	YA-281D	CAPRI	F-19	P-19							
	YA-281D	CAPRI	F-3	P-3							
	YA-282	CAPRI	F-5	P-5							
	YA-282	CAPRI S.	F-5	P-5							
	YA-282	NEO-DAKKI	F-5	P-5							
	YA-283D	CAPRI	F-19	P-19							
	YA-283D	CAPRI S.	F-19	P-19							
	YA-283D	NEO-DAKKI	F-19	P-19							
	YA-286D	CAPRI	F-1	P-1							
	YA-286D	CAPRI S.	F-1	P-1							
	YA-286D	NEO-DAKKI	F-1	P-1							
	YA-286D	CAPRI	F-3	P-3							
	YA-286D	CAPRI S.	F-3	P-3							
	YA-286D	NEO-DAKKI	F-3	P-3							
	YA-306	CAPRI	F-5	P-5							
	YA-306	CAPRI S.	F-5	P-5							
	YA-306	NEO-DAKKI	F-5	P-5							



### **JMA SPAIN**

JMA ALEJANDRO ALTUNA, S.L.U.  
Tel +34 943 79 30 00  
Bidekurtzeta, 6 P.O.Box - Apdo. 70  
20500 Arrasate - Mondragón  
Gipuzkoa – SPAIN  
[www.jma.es](http://www.jma.es)  
[ventas@jma.es](mailto:ventas@jma.es)

### **JMA FRANCE**

JMA FRANCE SAS  
Tel +33 01 39 22 42 10  
Technoparc  
13, rue Edouard Jeanneret  
F- 78306 Poissy Cedex  
[www.jmafrance.fr](http://www.jmafrance.fr)  
[service.commercial@jmafrance.fr](mailto:service.commercial@jmafrance.fr)

### **JMA POLSKA**

JMA POLSKA Sp. z o.o.  
Tel +48 42 635 12 80  
91- 342 Łódź, ul. Zbąszczyńska 3  
[www.jmapolska.pl](http://www.jmapolska.pl)  
[biuro@jmapolska.pl](mailto:biuro@jmapolska.pl)

### **JMA PORTUGAL**

ALTUNA PORTUGAL  
COMERCIO DE CHAVES UNIPessoal, LDA.  
Tel +351 219 947 470  
Rua de Goa Nº22  
2690-356 Santa Iria de Azoia  
[www.jmaportugal.com](http://www.jmaportugal.com)  
[comercial@jmaportugal.com](mailto:comercial@jmaportugal.com)

### **JMA UK**

SKS LTD  
Tel +44 144 229 1400  
Unit 2, Canalside Northbridge Road  
Berkhamsted  
Herts HP4 1EG  
[www.jmakeys.co.uk](http://www.jmakeys.co.uk)  
[sales@sk.co.uk](mailto:sales@sk.co.uk)

### **JMA MAROC**

JMA MAROC S.A.R.L.  
Tel +0520 150 535  
83,85 Bd Oued ZIZ, El Oulfa  
Casablanca  
[www.jma.ma](http://www.jma.ma)  
[jma@jma.ma](mailto:jma@jma.ma)

### **JMA MEXICO**

LLAVES ALTUNA DE MEXICO S.A de C.V  
Tel +52 33 3777 1600  
Av. Aviación No. 5520  
Col. San Juan de Ocotán  
C.P. 45019 Zapopan, Jalisco  
[www.jma.com.mx](http://www.jma.com.mx)  
[ventas@jma.com.mx](mailto:ventas@jma.com.mx)

### **JMA PERU**

JMA PERU S.A.C.  
Tel +51 639 9300  
Av. Los Paracas 130,  
Urbanización Salamanca,  
Distrito Ate, Lima  
[www.jma-peru.com](http://www.jma-peru.com)  
[info@jma-peru.com](mailto:info@jma-peru.com)

### **JMA USA**

ALTUNA GROUP USA INC.  
Tel +1 817 385 0515  
1513 Greenview Drive  
75050 Grand Prairie  
Texas  
[www.jmausa.com](http://www.jmausa.com)  
[info@jmausa.com](mailto:info@jmausa.com)



### **ALTUNA GROUP HEADQUARTERS**

Tel +34 943 79 30 00  
Fax +34 943 79 72 43  
Bidekurtzeta, 6 P.O.Box - Apdo. 70  
20500 Arrasate - Mondragón  
Gipuzkoa – SPAIN

Member of  
**Altuna Group**